

**The Relationship Between Aerobic Fitness and Brachial Endothelial Function on
Cerebrovascular Regulation**

by

Molly K. Courish

Submitted in partial fulfilment of the requirements
for the degree of Master of Science

at

Dalhousie University
Halifax, Nova Scotia
August 2024

Dalhousie University is located in Mi'kma'ki, the
ancestral and unceded territory of the Mi'kmaq.
We are all Treaty people.

© Copyright by Molly K. Courish, 2024

Table Of Contents

List of Tables.....	iv
List of Figures.....	v
Abstract.....	vi
List of Abbreviations.....	vii
Acknowledgements.....	ix
Chapter 1: Introduction.....	1
Chapter 2: Literature Review.....	5
2.1. Risk Factors and Prevalence of Cardiovascular & Cerebrovascular Diseases.....	5
2.2 Roles of Physical Activity & Aerobic Fitness on Disease Prevalence, & Mortality.....	6
2.3 Overview of the Cardiovascular System.....	9
2.3.1. Functional Anatomy of Blood Vessels.....	9
2.3.2 – Functional Anatomy of Vascular Smooth Muscle.....	11
2.3.3. Sympathetic Control of Vascular Smooth Muscle.....	13
2.3.4 – Functional Anatomy of The Vascular Endothelium.....	15
2.3.5 – Role of Endothelial-Derived Nitric Oxide.....	21
2.3.6 – Assessment of Brachial Endothelial-Dependent and -Independent Function.....	21
2.5 – Overview of the Cerebrovascular System.....	26
2.5.1 – Control of Cerebral Blood Flow.....	26
2.5.2 – Transcranial Doppler Assessment of MCA Velocity.....	33
2.5.3 – Assessment of Cerebrovascular Reactivity.....	34
2.6 – Impact of Aging on Peripheral and Cerebral Vascular Function.....	35
2.7 – Impact of Aerobic Fitness on Vascular Function in Older Adults.....	37
2.8 – Purpose & Hypothesis.....	42
Chapter 3: Methods.....	44
3.1 Participant Information.....	44
3.2 Experimental Measures and Analyses.....	45
3.2.1 –Assessment of Aerobic Fitness.....	45
3.2.2 – Assessment of Habitual Activity.....	47
3.2.3 – Measurement of Middle Cerebral Artery Red Blood Cell Velocity.....	48
3.2.4 - Assessments of Resting Cardiovascular Function & Cerebrovascular Reactivity.....	49
3.2.5 – Assessments of Brachial Artery Function.....	51
3.3 – Experimental Design.....	54
3.4 - Statistical Analysis.....	54
Chapter 4: Results.....	56

4.1 Participant Characteristics	56
4.2 Resting Systemic Hemodynamics & Cerebrovascular Outcomes	59
4.3 Relationships Between Aerobic Fitness & Habitual Activity Versus Cerebrovascular Outcomes	59
4.4. Brachial Artery Function Outcomes	60
4.5 Relationships Between Aerobic Fitness & Habitual Activity versus Brachial Artery Outcomes	63
4.6 Relationships Between Brachial Artery Outcomes Versus Cerebrovascular Regulation	65
Chapter 5 – Discussion	67
5.1 Impact of Age on Aerobic Fitness	68
5.2 Impact of Age on Cerebrovascular Function	69
5.3 Impact of Aerobic Fitness on Cerebrovascular Function	71
5.4 Impact of Age on Brachial Endothelial Function	74
5.5 Impact of Aerobic Fitness on Brachial Endothelial Function.....	75
5.6 Impact of Brachial Artery Function on Cerebrovascular Function	79
5.7 Strengths & Limitations.....	80
5.8 Conclusions.....	81
References.....	83
Appendix A: Dalhousie HSREB Letter of Approval	109
Appendix B: Supplemental Figure 1 – Aerobic Fitness & Brachial FMD vs Relative CVR	110
Appendix C: Supplemental Figure 2 – Aerobic Fitness vs Resting MCAv & CVR.....	111
Appendix D: Supplemental Figure 3 – Aerobic Fitness vs Brachial FMD & NMD	112

List of Tables

Table 4.1 – Participant descriptive characteristics, aerobic fitness and habitual activity outcomes.....	54
Table 4.2 – Resting systemic, cerebral hemodynamics, and cerebrovascular reactivity outcomes between age groups.....	55
Table 4.3 – Comparison of brachial artery outcomes between age groups.....	60

List of Figures

Figure 2.1 – The impact of leisure time physical activity on all-cause mortality and life expectancy.....	6
Figure 2.2 – The cross-sectional view of the artery layers.....	10
Figure 2.3 – The contraction and relaxation of vascular smooth muscle cells.....	11
Figure 2.4 – Vascular smooth muscle contraction by myosin light chain kinase.....	12
Figure 2.5 – Adrenergic receptors and signaling pathways that regulate vascular smooth muscle contraction.....	14
Figure 2.6 – Endothelial-derived substances involved in the regulation of vascular smooth muscle	15
Figure 2.7 – Nitric oxide production in the endothelium and vascular smooth muscle relaxation.....	17
Figure 2.8 – Calcium-independent and -dependent activation of endothelial nitric oxide synthase.....	18
Figure 2.9 – Sympathetic & parasympathetic regulation of the heart & vasculature...	24
Figure 2.10 – Anatomy of the cerebral arterial circulation.....	27
Figure 2.11 - Identification of the transtemporal window and TCD probe placement...	33
Figure 2.12 - The comparison of relative cerebral blood flow (CBF) between Masters athletes (MA), sedentary elderly (SE), and young controls (YC).....	37
Figure 2.13 – The negative association between aerobic fitness and cerebrovascular reactivity in older adults.....	38
Figure 2.14 – The positive association between aerobic fitness and cerebrovascular reactivity in older adults	39
Figure 3.1 – Schematic view of the transcranial Doppler probe and custom headset...	45
Figure 3.2 – Brachial artery assessment of flow-mediated dilation.....	49
Figure 4.1 – Relationship between aerobic fitness and cerebrovascular outcomes	58
Figure 4.2 – Relationship between aerobic fitness and peripheral endothelial function outcomes.....	62
Figure 4.3 – Relationship between brachial FMD and cerebrovascular outcomes	63

Abstract

Aging is associated with declining function of peripheral (i.e., brachial) and cerebral (i.e., middle cerebral artery) arteries, which increases the risk for the development of cardiovascular and cerebrovascular disease. Higher levels of aerobic fitness counteract some of these age-related reductions in brachial artery function. However, the impact of aerobic fitness on cerebral artery function is less certain. This project aims to explore whether aerobic fitness and brachial endothelial function are related to cerebrovascular regulation in younger and older adults. The present project assessed the hypothesis that higher aerobic fitness would be positively associated with brachial flow-mediated dilation (FMD) outcomes and resting middle cerebral artery velocity (MCAv), but the relationship between cerebrovascular reactivity (CVR), aerobic fitness and brachial FMD is unclear, given differing reports in the literature. Aerobic fitness ($\dot{V}O_{2peak}$, via indirect calorimetry), as well as brachial FMD (via duplex ultrasonography), MCAv (via transcranial Doppler) and CVR (MCAv response to breath holding), were assessed in a group of healthy younger (n=15) and older (n=14) adults. Relative and absolute $\dot{V}O_{2peak}$ were not related to brachial-FMD, MCAv or CVR (all, $p>0.179$). Brachial-FMD was not related to MCAv or CVR (both, $p>0.08$). These results indicate that aerobic fitness was not related to brachial FMD or cerebrovascular outcomes in a group of younger and older adults. Furthermore, brachial endothelial function may not be indicative of cerebrovascular function in younger and older adults.

List of Abbreviations

ACA = Anterior cerebral artery

Ach = Acetylcholine

Ca²⁺ = Calcium

cAMP = cyclic adenosine monophosphate

CBF = Cerebral blood flow

CBVD = Cerebrovascular disease

CBVR = Cerebrovascular resistance

CO = Cardiac output

CPP = Cerebral perfusion pressure

CVD = Cardiovascular disease

CVR = Cerebrovascular reactivity

EDHF = Endothelial-derived hyperpolarizing factors

eNOS = Endothelial nitric oxide synthase

FMD = Flow-mediated dilation

HR = Heart rate

ICA = Internal carotid arteries

ICP = Intracranial pressure

MAP = Mean arterial pressure

MCA = Middle cerebral artery

MCA_v = Middle cerebral artery velocity

MET = Metabolic equivalent of task

MLC = Myosin light chain

MLCK = Myosin light chain kinase

MPA = Moderate physical activity

MVPA = Moderate-to-vigorous physical activity

NE = Norepinephrine

NMD = Nitroglycerin-mediated dilation
NO = Nitric oxide
NTS = Nucleus of the solitary tract
PaCO₂ = Arterial partial pressure of carbon dioxide
PGI₂ = Prostaglandin I
sGC = Soluble guanylyl cyclase
SR_{AUC} = Shear rate area under the curve
SV = Stroke volume
TCD = Transcranial Doppler
TPR = Total peripheral resistance
VPA = Vigorous physical activity

Acknowledgements

I would like to thank my supervisor, Dr. Derek Kimmerly, for his support and guidance, which has provided me with the motivation and inspiration to further pursue a research career. I would also like to thank my thesis committee, Dr. Said Mekari and Dr. Myles O'Brien, for their valuable expertise and support throughout this project, as well as my external examiner, Dr. Scott Kehler. A special thanks to Abigail Wickens and Chris Consmueller for their dedication to this research, including their time to analyze data for this project. I would like to thank past and present ACCE lab members for their friendships, emotional and academic support, and for challenging me to be better every day. Finally, I would like to thank my friends and family for their support throughout this project.

CHAPTER 1: INTRODUCTION

The Canadian population of older adults (aged ≥ 65 years) is rapidly growing and expected to reach $\sim 30\%$ by 2030 (1). Chronological age is a major risk factor for cardiovascular disease (CVD) (2), the second leading cause of death in Canada (3). Cerebrovascular disease (CBVD, disease of brain blood vessels) is the fourth leading cause of death among Canadians and may involve vessel lumen narrowing (stenosis), clot formation (thrombosis), blockage (embolism) and/or vessel rupture (hemorrhage) (4–6). One in 12 Canadians >20 years old are living with a form of CVD, with the chance of mortality increasing by over 600% in adults over the age of 40 (3). The risk of developing CBVD increases rapidly over the age of 55, with $\sim 25\%$ of Canadians currently living with stroke being younger than 65 years old (3). Non-modifiable risk factors for both CVD and CBVD include age, sex, and genetics, while modifiable risk factors include obesity, alcohol, smoking, and physical inactivity (7).

An important factor in the early detection of CVD (8) and CBVD is vascular endothelial health (9). Endothelial dysfunction can be characterized as an attenuated ability of the peripheral vasculature to dilate in response to physical and or chemical stimuli (10). Arterial endothelial function can be assessed by the flow-mediated dilation (FMD) protocol, which involves measuring a vasodilatory response following a period of reactive hyperemia, induced by a brief period (e.g., 5 minutes) of distal ischemia (11). For every 1% increase in the relative brachial artery FMD response (% baseline diameter), there is a $\sim 13\%$ relative risk reduction in experiencing an adverse cardiovascular event (12). Furthermore, older adults have lower relative brachial FMD responses than younger adults, indicating endothelial function declines with age (13). In

addition, an important factor in the early detection of CBVD is insufficient cerebral blood flow (CBF) and poor cerebral vascular function, such as attenuated cerebrovascular reactivity (CVR) responses (14, 15). Cerebral blood flow is commonly assessed indirectly by measuring red blood cell velocity in the middle cerebral artery (MCAv) using transcranial Doppler ultrasonography (TCD) (16). Cerebrovascular reactivity refers to the ability of cerebral arteries to dilate and increase CBF in response to elevated carbon dioxide (CO₂) levels (17). Cerebrovascular reactivity can be assessed by quantifying increases in MCAv induced by breath-hold-mediated elevations in arterial (PaCO₂) or end-tidal partial pressure of carbon dioxide (P_{ET}CO₂) (18). This protocol will be used in the present study to assess CVR.

Endothelial-dependent mechanisms have been implicated in partially mediating CVR responses (19, 20), with previous work demonstrating a link between brachial endothelial-dependent vasodilatory responses with CVR in young healthy adults (21, 22). However, more recent work in young healthy adults has determined that brachial FMD responses were not correlated with cerebrovascular endothelial-dependent responses (23). Altogether, it is unclear whether a direct association exists between brachial endothelial-dependent and CVR responses in healthy older adults who experience corresponding reductions in both brachial and cerebral vascular outcomes. Specifically, healthy aging is associated with reduced resting CBF and CVR responses (24–26). Using a repeated breath-hold protocol, Klein et al. (26) highlighted that older adults exhibited attenuated resting MCAv and CVR responses compared to younger adults. Furthermore, aging associated reductions in CVR have been attributed to endothelial dysfunction (21, 27). However, age-related decreases in brachial endothelial and cerebral vascular function

may be attenuated in those who engage in more aerobic-based physical activity or exercise.

Aerobic-based physical activity/exercise is the most effective modifiable risk factor in preventing the development of CVD and CBVD (28–31). The gold standard metric of aerobic fitness is maximal/peak oxygen uptake ($\dot{V}O_{2\text{max/peak}}$), which can be quantified via indirect calorimetry using an incremental exercise test (32). The impact of maintaining higher aerobic fitness levels on the preservation and/or improvement of peripheral arterial health is well established. Specifically, a 10% increase in aerobic fitness is associated with a 1% increase in the relative brachial FMD response (33, 34). Continuous engagement in aerobic exercise is also associated with superior FMD responses among younger and older adults (35). Additionally, better aerobic fitness attenuates age-related declines in CBF, with higher resting CBF outcomes observed in Masters athletes (36) and older adults with higher $\dot{V}O_{2\text{peak}}$ (37, 38). Although higher aerobic fitness is associated with better CVR in young adults (39, 40), there is conflicting evidence regarding the relationship between aerobic fitness versus CVR in middle-aged and older adults (41). While Barnes et al. (42) observed a positive relationship between CVR and $\dot{V}O_{2\text{peak}}$ in older adults, others have reported an inverse association (36, 41). However, DuBose et al. (43) demonstrated a nonlinear quadratic relationship between CVR and $\dot{V}O_{2\text{peak}}$ among a group of middle-aged and older adults across varying levels of aerobic fitness (43). Finally, a recent systematic review and meta-analyses that included studies in younger and older healthy adults observed a positive effect of higher aerobic fitness on CVR (39, 40). In summary, there is no clear association between aerobic fitness and cerebral vascular outcomes, especially amongst older adults.

Although the vascular endothelium has been implicated with CVR, which is attenuated with ageing and may improve with higher aerobic fitness, no research has explored whether brachial endothelial-dependent vasodilation may mediate the relationships between aerobic fitness, and cerebral vascular health outcomes in younger and older adults. Therefore, the primary objectives of the present study were to explore in a cohort of younger and older adults whether: 1) aerobic fitness was related to resting MCAv, CVR and/or brachial FMD, and 2) brachial FMD and CVR responses were co-related. Currently, the known links between brachial endothelial-dependent and CVR responses are based on nitric oxide- (NO) mediated vasodilatory assessments (21, 22). As such, a secondary objective was to explore whether brachial low-flow-mediated vasoconstrictor (L-FMC) responses, which have been linked with endothelial-derived hyperpolarizing factors (EDHFs) (44) and improved with higher aerobic fitness in younger (45) and older adults (46), are also associated with CVR. It was hypothesized that higher aerobic fitness would be associated with better brachial FMD, L-FMC and resting MCAv (CBF). Considering the discrepancy in the existing literature, it was unclear whether aerobic fitness would be related to CVR responses. Furthermore, it was uncertain whether brachial FMD outcomes would be associated with CVR responses.

CHAPTER 2: LITERATURE REVIEW

2.1. Risk Factors and Prevalence of Cardiovascular & Cerebrovascular Diseases

The Canadian population of older adults (aged ≥ 65 years) is rapidly growing and is expected to reach $\sim 30\%$ by 2030 (1). In Nova Scotia, older adults comprise $\sim 23\%$ of the population as of 2022, which is constantly rising (1). Chronological age is a major risk factor for CVD (2), the second leading cause of death in Canada (3). Cardiovascular disease is a group of heart and blood vessel disorders that leads to cardiac and/or vascular damage, end-organ failure, and mortality. Additional non-modifiable risk factors for CVD include male sex, family history, and genetics (47). Furthermore, modifiable risk factors include smoking, physical inactivity, obesity, diabetes mellitus, hypertension, and hyperlipidemia, which negatively influence CVD-related mortality and morbidity (48–50). One in 12 Canadians >20 years old are living with a form of CVD, with the chance of mortality increasing by over 600% in adults over the age of 40 (3). Approximately 19% of older adults in Nova Scotia have been diagnosed with a form of CVD (51). In addition, aging is directly related to the development of brain vessel-related diseases.

Cerebrovascular disease (CBVD, e.g., ischemic, or hemorrhagic stroke) is the fourth leading cause of death among Canadians and may involve vessel lumen narrowing (stenosis), clot formation (thrombosis), blockage (embolism) and/or vessel rupture (hemorrhage) (4–6). Cerebrovascular disease risk increases rapidly over the age of 55, and $\sim 75\%$ of Canadians living with stroke are >65 years old (3). Non-modifiable risk factors for CBVD include age (i.e., older adults), sex (i.e., female), ethnicity, and genetic factors, while modifiable risk factors include CVD, diabetes mellitus, hyperlipidemia, obesity, smoking, alcohol, oral contraceptive use, and physical inactivity (7).

2.2 Roles of Physical Activity & Aerobic Fitness on Disease Prevalence, & Mortality

Regular engagement in physical activity reduces the risk of chronic disease and all-cause mortality (52). The Canadian Society for Exercise Physiology recommends that adults engage in at least 150 minutes per week of moderate-intensity physical activity (53). The intensity of physical activities can be measured in terms of metabolic equivalents of task, which reflects the rate of oxygen consumption during a given activity (54). One metabolic equivalent can be defined as a relative resting oxygen consumption rate of ~ 3.5 ml/kg/min (young adults), or ~ 2.7 ml/kg/min (older adults) (53). Moore et al. (55) investigated the impact of weekly leisure-time physical activity volume on the risk of mortality from 6 pooled cohort studies (55). They demonstrated that as the volume of physical activity increased, all-cause mortality risk decreased, while life expectancy was higher in healthy middle-aged and older adults (>40 years old) after a 10-year follow-up period (Figure 2.1) (55).

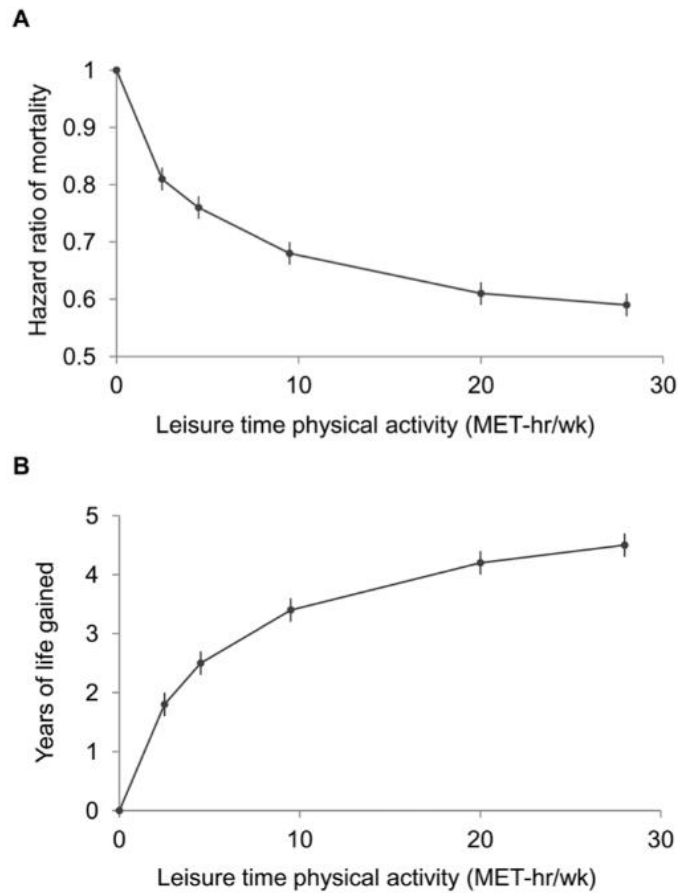

Figure 2.1. The impact of leisure time physical activity volume on all-cause mortality (Panel A) and life expectancy (Panel B) among middle-aged and older-aged adults (55). Greater leisure time physical activity was associated with lower mortality and longer life expectancy. The hazard ratio reflects fractional decreases in mortality compared to no leisure-time physical activity. MET, metabolic equivalents.

Aerobic-based physical activity and exercise are the most effective lifestyle modifications for the prevention of CVD and CBVD (28–31). Having higher aerobic fitness is associated with a decrease in the development of CVD risk factors (i.e., hypertension, diabetes, hyperlipidemia) in older (56, 57) and younger adults (56, 57), as well as a reduction in CVD-specific and all-cause mortality (58). The peak or maximum ability of the body to utilize oxygen (i.e., $\dot{V}O_{2\text{peak/max}}$) can be quantified via indirect calorimetry using an incremental exercise test and is considered the gold standard measure of aerobic fitness (32). A higher $\dot{V}O_{2\text{peak}}$ is a strong, independent predictor

linked with a lower risk of all-cause and disease-specific mortality (59). Specifically, an increase in relative $\dot{V}O_{2peak}$ of $1 \text{ ml}\cdot\text{kg}^{-1}\cdot\text{min}^{-1}$ is associated with a 9% relative risk reduction in all-cause mortality (60). Habitual activity patterns may impact levels of aerobic fitness, as engaging in increased light moderate-to-vigorous physical activity (3 - >6 METS), and less sedentary time are associated with higher levels of aerobic fitness (61, 62).

Furthermore, there is an inverse relationship between $\dot{V}O_{2peak}$ and the risk of stroke (63, 64). The American Stroke Association recommends engaging in regular physical activity as a primary prevention method for the development of stroke or other forms of CBVD (63–65). This could be related to the known positive effects that aerobic fitness has on resting CBF (66), as increased resting CBF is a known factor for the prevention of CBVD (14). Higher aerobic fitness is also indicative of better overall cardiovascular health, as a lower level of aerobic fitness is a strong predictor for the development of CVD (67, 68). Those with a lower level of aerobic fitness are known to have higher blood pressure, hyperlipidemia, and a greater body mass index, all known modifiable risk factors for the onset of CVD (48, 50, 69). The specific mechanisms related to the impact of aerobic fitness on CBVD outcomes (i.e., cerebral vascular function) and CVD (i.e., peripheral artery function) will be discussed further in-depth later in this document, as this project aims to understand the relationship between aerobic fitness, peripheral artery function, and cerebral artery function. The following sections will provide an overview of cardiovascular functional anatomy to help preface information pertaining to the assessments of brachial artery health and cardiovascular responses related to cerebrovascular function.

2.3 Overview of the Cardiovascular System

2.3.1. Functional Anatomy of Blood Vessels

In addition to aiding with temperature regulation, the cardiovascular system is primarily responsible for the delivery of oxygen, hormones, and nutrients, as well as the removal of carbon dioxide and other metabolic by-products from body tissues (70). The two primary components of the cardiovascular system are the heart and the blood vessels (71). The systemic vascular system incorporates all blood vessels (i.e., arterioles, capillaries, venules, veins) external to the pulmonary and coronary circulations (72). Except for capillaries, blood vessels are comprised of three concentric layers as shown in Figure 2.2. The outermost layer, *tunica adventitia (or externa)*, is comprised of connective tissue (i.e., collagen, elastin), fibroblasts, *vasa vasorum* (i.e., small blood vessels that supply/drain the walls of larger vessels), and *nervi vasorum* (i.e., vascular nerves) and is the point of innervation for sympathetic adrenergic nerve endings (73, 74). The middle layer (*tunica media*) contains vascular smooth muscle cells responsible for changes in vessel lumen diameter and vascular tone (i.e., contractile activity of the vascular smooth muscle of the vessel) and is separated from the innermost layer (*tunica intima*) by the internal elastic lamina (73). Vascular tone is the degree to which the vascular smooth muscle cells contract relative to the maximally relaxed state. The innermost layer (*tunica intima*) is comprised of a single layer of endothelial cells (i.e., the endothelium), which are responsible for regulating the exchange of materials (i.e., oxygen, glucose) between the bloodstream and underlying tissues (73). Capillaries only consist of the *tunica intima*. The primary functions of the endothelium are to reduce local coagulation or clotting (i.e., thrombosis) and inflammation, as well as to maintain

vascular tone (75). The endothelium detects hemodynamic changes (i.e., blood flow) and blood-borne chemicals (i.e., acetylcholine) to release vasoactive factors that diffuse into the *tunica media* and act on the vascular smooth muscle cells, causing contraction (i.e., vasoconstriction) or relaxation (i.e., vasodilation) (75).

While this generalized gross anatomical structure is similar between blood vessel types, some differences exist depending on the role of the vessel. Conduit arteries (e.g., aorta, carotid, and brachial arteries) provide a low-resistance path of flow (76).

Resistance vessels (i.e., arterioles and small arteries), are smaller branches that connect smaller arteries with capillaries and are important sites for the regulation of mean arterial pressure (MAP) and tissue blood flow (72). While resistance vessels have thinner walls compared to conduit arteries, they have relatively more vascular smooth muscle, allowing for a greater magnitude of vasodilation or vasoconstriction (Figure 2.2C) (77).

Furthermore, veins and venules contain relatively less vascular smooth muscle and connective tissue, which results in thinner walls (78). Thinner venous walls allow for a wider lumen and greater capacity to store blood (Figure 2.2B) (78). Veins are referred to as capacitance vessels that contain most of the blood volume at rest (79). The next few sections will expand upon the functional anatomy of vascular smooth muscle and endothelial cells.

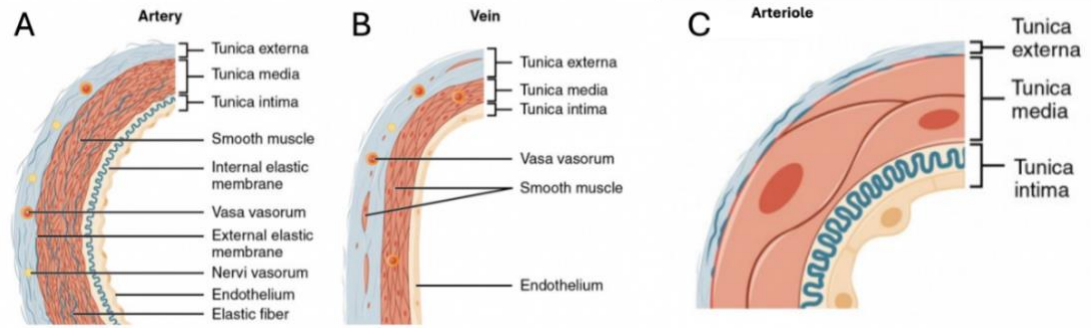

Figure 2.2. Cross-sectional views of the concentric layers that comprise conduit arteries (A), veins (B), and arterioles (C). The *tunica externa*, is composed primarily of collagen and elastic fibers. The *tunica externa* is the innervation point for sympathetic nerves, *nervi vasorum*, and in arteries (A) and veins (B), small blood vessels that supply larger vessels, *vaso vasorum* are found in the *tunica externa*. The *tunica media*, is composed primarily of vascular smooth muscle cells and is responsible for adjusting lumen diameter and vascular tone. The *tunica intima* is comprised of endothelial cells, which regulate the exchange of materials (e.g., oxygen) between the blood and surrounding tissues (80).

2.3.2 – Functional Anatomy of Vascular Smooth Muscle

Vascular smooth muscle cells are fusiform with a large central nucleus surrounded by an abundance of endoplasmic reticulum (81). Vascular smooth muscle cells contain the protein filaments actin and myosin that interact to form cross-bridges and stimulate contraction (81). Thin actin filaments comprise linear polymers, while thick myosin filaments comprise both heavy and light protein chains (82). Heavy chains of myosin consist of a globular head and a long α -helical tail (82). The α -helical tails of two heavy chains twist around one another to form a coil, while two light chains wrap around the necks of each globular head (82). Actin filaments are anchored within the inner surface of the sarcolemma by dense bodies or dense bands (73). Each myosin filament is surrounded by ~ 15 actin filaments (73). The actin and myosin filaments are arranged in an array, to allow for multidirectional contraction (Figure 2.3A) (81). Vascular smooth muscle cells are connected via gap junctions, which allow for the spread of depolarization between

cells (73). At rest, the vascular smooth muscle is typically in a partial state of contraction, which determines the resting diameter of the vessel (73).

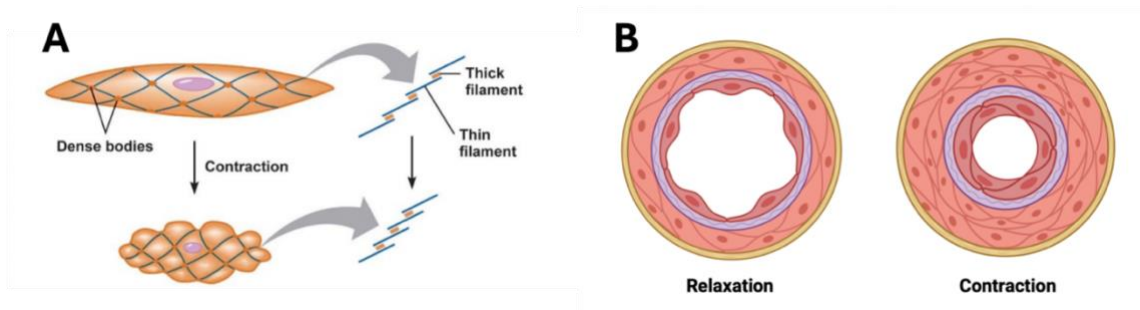

Figure 2.3. Panel A: The thin (actin) and thick (myosin) filaments of vascular smooth muscle cells are arranged in an array pattern, allowing for an elongated flat cell when relaxed. Upon the formation of cross-bridges, the filaments shorten and the cell contracts (81, 82). Panel B: Corresponding changes in vessel lumen diameter during vascular smooth muscle cell relaxation and contraction. Figure created with BioRender.com.

Vascular smooth muscle cell contraction is stimulated by an increase in intracellular calcium concentration. This can occur via the opening of receptor-operated or voltage-gated (e.g., L-type) calcium channels on the sarcolemma or the sarcoplasmic reticulum (73). Intracellular calcium binds to the modulating protein calmodulin to form a calcium-calmodulin complex, which activates the enzyme myosin light chain kinase (MLCK) in the presence of adenosine triphosphate (73). This enzyme phosphorylates the myosin light chains to permit the formation of cross-bridges, leading to smooth muscle cell contraction (i.e., vasoconstriction) (73). With decreased intracellular calcium concentrations, the enzyme myosin light chain phosphatase removes the phosphate group from the myosin light chains, which causes actin and myosin to detach with subsequent relaxation (i.e., vasodilation) (73). In response to the binding of certain hormones (e.g., acetylcholine, epinephrine) to luminal-facing stimulatory G-protein receptors, adenylate cyclase is activated and produces cyclic adenosine monophosphate (cAMP), which inhibits MLCK and promotes vasodilation (83) (Figure 2.4).

2.3.3. Sympathetic Control of Vascular Smooth Muscle

The autonomic nervous system plays a key role in the involuntary regulation of both cardiac and vascular function (84). The regulation of sympathetic outflow toward the vasculature depends on peripheral inhibitory and excitatory input, as well as central modulators (85). Peripheral afferent inputs (e.g., arterial baroreceptors, cardiopulmonary baroreceptors, peripheral chemoreceptors) terminate on the nucleus of the solitary tract (NTS) in the medulla oblongata (85). The NTS sends information to either the rostral ventrolateral medulla (RVLM) directly or through the caudal ventrolateral medulla (CVLM) (86). The RVLM excites sympathetic preganglionic neurons in the spinal cord, stimulating sympathetic outflow activity (86). Additionally, central modulators (e.g., nitric oxide, reactive oxygen species) provide stimuli to the RVLM or the spinal cord, contributing to the magnitude of sympathetic outflow to the vasculature (85). These central neural control centers will be discussed further later in this chapter.

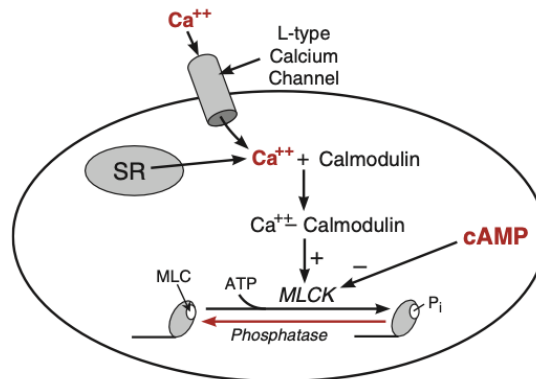

Figure 2.4. Vascular smooth muscle contraction by myosin light chain kinase (MLCK). Increased intracellular calcium (Ca^{++}) via the opening of L-type (sarcolemma) or receptor-operated channels [sarcolemma or sarcoplasmic reticulum (SR)] binds with calmodulin to create a calcium-calmodulin complex. This increases the activity of MLCK, which phosphorylates the myosin light chains (MLC) to form cross-bridges and initiate contraction. Decreased intracellular Ca^{++} results in less MLCK activity, as well as greater activity of myosin light chain phosphatase, which removes phosphate groups from the MLC, causing relaxation and vasodilation. Cyclic adenosine monophosphate (cAMP) also inhibits MLCK to cause relaxation (73).

Post-ganglionic sympathetic nerves innervate vascular smooth muscle cells through the *tunica adventitia* (i.e., *nervi vasorum*), and release neurotransmitters (e.g., norepinephrine, neuropeptide Y and adenosine triphosphate) (87). Norepinephrine binds with post-synaptic α_1 - and α_2 -adrenergic receptors on vascular smooth muscle cells to cause vasoconstriction (Figure 2.5). Specifically, when norepinephrine binds to α_1 -receptors, phospholipase C is stimulated through a G_q -protein coupled receptor mechanism, leading to the formation of inositol triphosphate and diacylglycerol, resulting in an elevated intracellular Ca^{2+} concentration (73) (Figure 2.5). When norepinephrine binds to α_2 -receptors, coupled to an inhibitory G-protein, adenylate cyclase activity is reduced, which lessens cAMP concentration and the corresponding inhibitory effect on MLCK to promote vasoconstriction (88) (Figure 2.5). When co-released with norepinephrine, adenosine triphosphate binds to purinergic P2X receptors on vascular smooth muscle, initiating rapid depolarization via the opening of L-type calcium channels, leading to vasoconstriction (89). Additionally, neuropeptide Y binds to Y1 receptors, activating G_α -proteins that inhibit adenylate cyclase, attenuating cAMP synthesis, and opening L-type calcium channels to promote vasoconstriction (90) (Figure 2.5).

In contrast, plasma catecholamines bind with lumen-facing β_2 -adrenergic receptors (linked with a stimulatory G protein) to cause vasodilation (88) via activation of adenylate cyclase, increased cAMP production and subsequent inhibition of MLCK (88). Furthermore, prejunctional α_2 -adrenoreceptors exist on the sympathetic nerve terminals. These receptors provide negative feedback control of norepinephrine release (88) (Figure 2.5).

2.3.4 – Functional Anatomy of The Vascular Endothelium

The endothelium releases vasoactive substances in response to hemodynamic changes or blood-borne chemicals (e.g., bradykinin, and acetylcholine). Vasodilatory factors released by the endothelium include nitric oxide (NO), prostacyclin, and endothelium-derived hyperpolarizing factors, while the potent vasoconstrictor endothelin-1 can also be produced (Figure 2.6) (91).

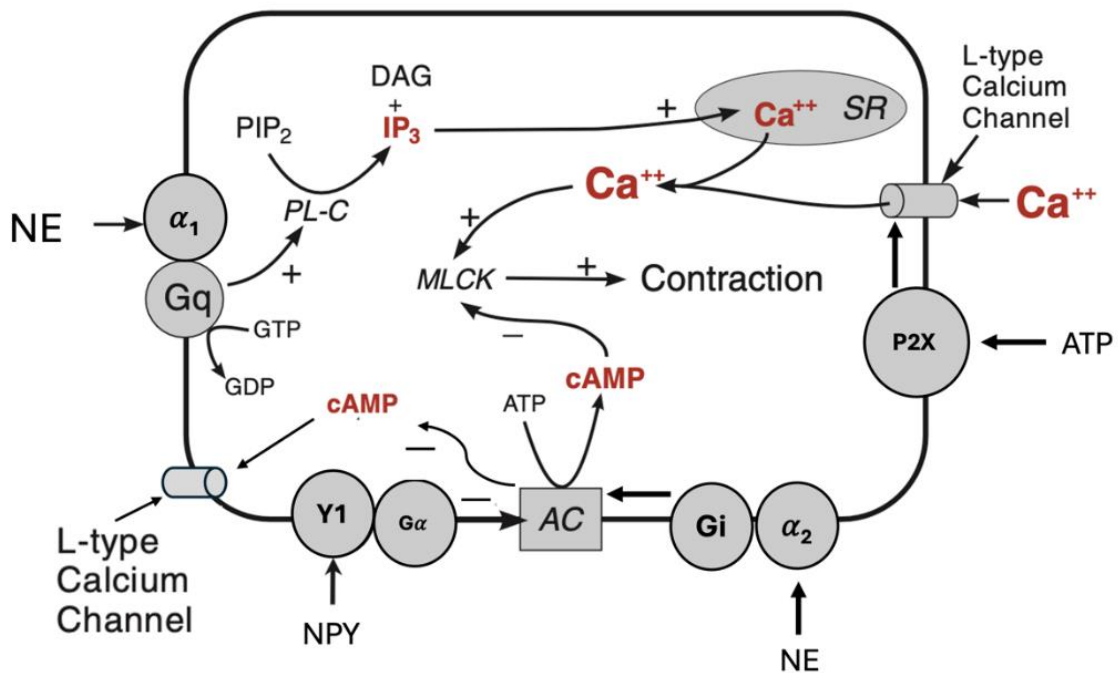

Figure 2.5. Adrenergic- and non-adrenergic receptor signaling pathways that induce vasoconstriction. Norepinephrine (NE) binds to α_1 -adrenoreceptors coupled to a Gq-protein, activating phospholipase C (PL-C), causing the formation of inositol triphosphate (IP₃) and diacylglycerol (DAG) from phosphatidylinositol 4,5-bisphosphate (PIP₂). IP₃ then releases calcium (Ca⁺⁺) from the sarcoplasmic reticulum (SR), increasing intracellular Ca⁺⁺ concentration, and stimulating myosin light chain kinase (MLCK) activity to increase vasoconstriction. NE also binds to α_2 -adrenoreceptors coupled to a Gi-protein, which inhibits adenylyl cyclase (AC) activity, reducing the production of cyclic adenosine monophosphate (cAMP), removing the inhibitory effect on MLCK, causing vasoconstriction. Neuropeptide Y (NPY) binds to Y1-receptors, coupled with a G α -protein, to inhibit AC, reducing cAMP synthesis, and promoting the opening of L-type calcium channels to increase intracellular Ca⁺⁺ concentrations, promoting vasoconstriction. Adenosine triphosphate (ATP) binds to P2X receptors when co-released with NE, opening L-type calcium channels (73).

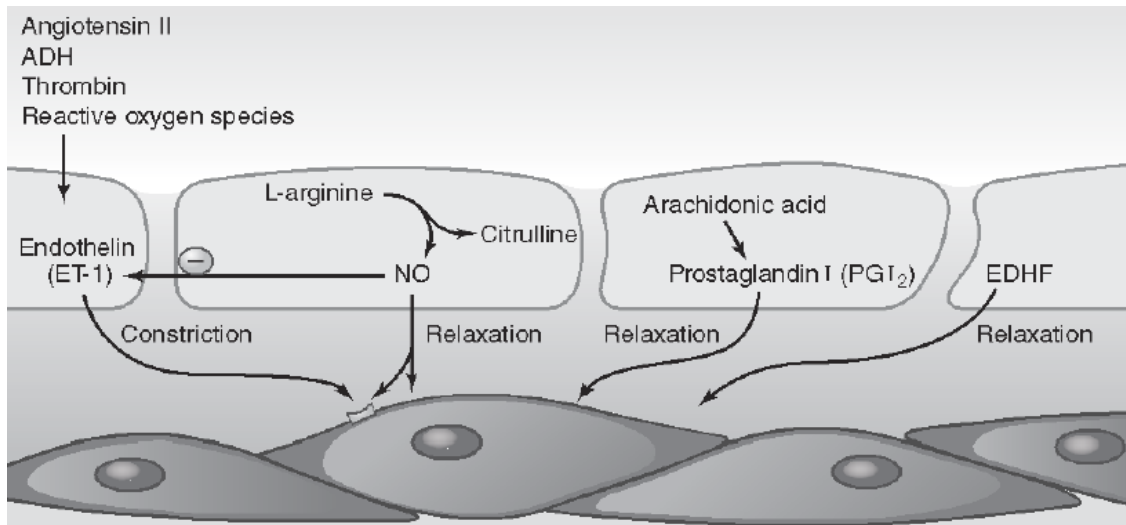

Figure 2.6. Endothelial-derived substances involved in the regulation of vascular smooth muscle. Endothelin-1 (ET-1) elicits vasoconstriction, while nitric oxide (NO), prostaglandin I (PGI₂), and endothelial-derived hyperpolarizing factors (EDHF) elicit vasodilation (92). ADH, anti-diuretic hormone.

Nitric oxide is a potent vasodilator that is synthesized by endothelial nitric oxide synthase (eNOS) in both calcium-dependent and -independent manners (91). When agonistic molecules bind to receptors on the endothelial membrane (e.g., bradykinin, acetylcholine, thrombin) intracellular calcium concentration increases, which binds to calmodulin (91). Simultaneously, eNOS detaches from the protein caveolin, activating the enzyme (91). The calcium-calmodulin complex then binds to the active eNOS, which converts the readily available amino acid L-arginine into L-citrulline and NO with assistance from the cofactors nicotinamide adenine dinucleotide phosphate and tetrahydrobiopterin (91). A reduction in endothelial calcium concentration causes the calcium-calmodulin complex to dissociate, which inhibits eNOS. Shear stress, or the tangential force of blood flow on the surface of the endothelium, can also increase NO synthesis by increasing intracellular calcium concentration via calcium-gated ion channels (91). Calcium-dependent NO production by the endothelium and diffusion into

the vascular smooth muscle is outlined in Figures 2.7 and 2.8. NO can also be synthesized by eNOS activation through a calcium-independent mechanism (80). An increase in blood flow and accompanying shear stress causes eNOS phosphorylation via Protein Kinase-A and Protein Kinase-B (80). Specifically, phosphorylation of eNOS on serine sites 635 and 1177 promotes eNOS activation (Figure 2.8) (80). Following synthesis, NO diffuses into the underlying vascular smooth muscles, where it binds to and activates the receptor enzyme soluble guanylyl cyclase (sGC) (91). Activated soluble guanylyl cyclase converts guanosine triphosphate to the second messenger cyclic guanosine monophosphate, which activates protein kinase G to stimulate myosin light chain phosphatase (73), reducing cross-bridge formation to inhibit contraction and cause vasodilation (91).

Aside from NO, there are additional endothelial-derived vasodilators (i.e., endothelial-derived hyperpolarizing factors and prostaglandins) and vasoconstrictors (i.e., endothelin-1). The production of endothelial-derived hyperpolarizing factors (e.g., epoxyeicosatrienoic acid, potassium ions) occurs when agonistic molecules (i.e., acetylcholine, bradykinin) bind to receptors on the endothelium, or shear stress increases, resulting in higher intracellular calcium concentration (91). This results in the activation of cytosolic phospholipase A₂, which converts phospholipids into arachidonic acid (93). Arachidonic acid activates cytochrome p450 epoxygenase to produce epoxyeicosatrienoic acid, which opens voltage-gated potassium-ion channels, resulting in an efflux of potassium, decreasing the membrane potential of the vascular smooth muscle cells (i.e., hyperpolarization) (93). Vascular smooth muscle hyperpolarization closes sarcolemma

voltage-gated calcium channels, decreasing intracellular concentrations and causing vasodilation (93).

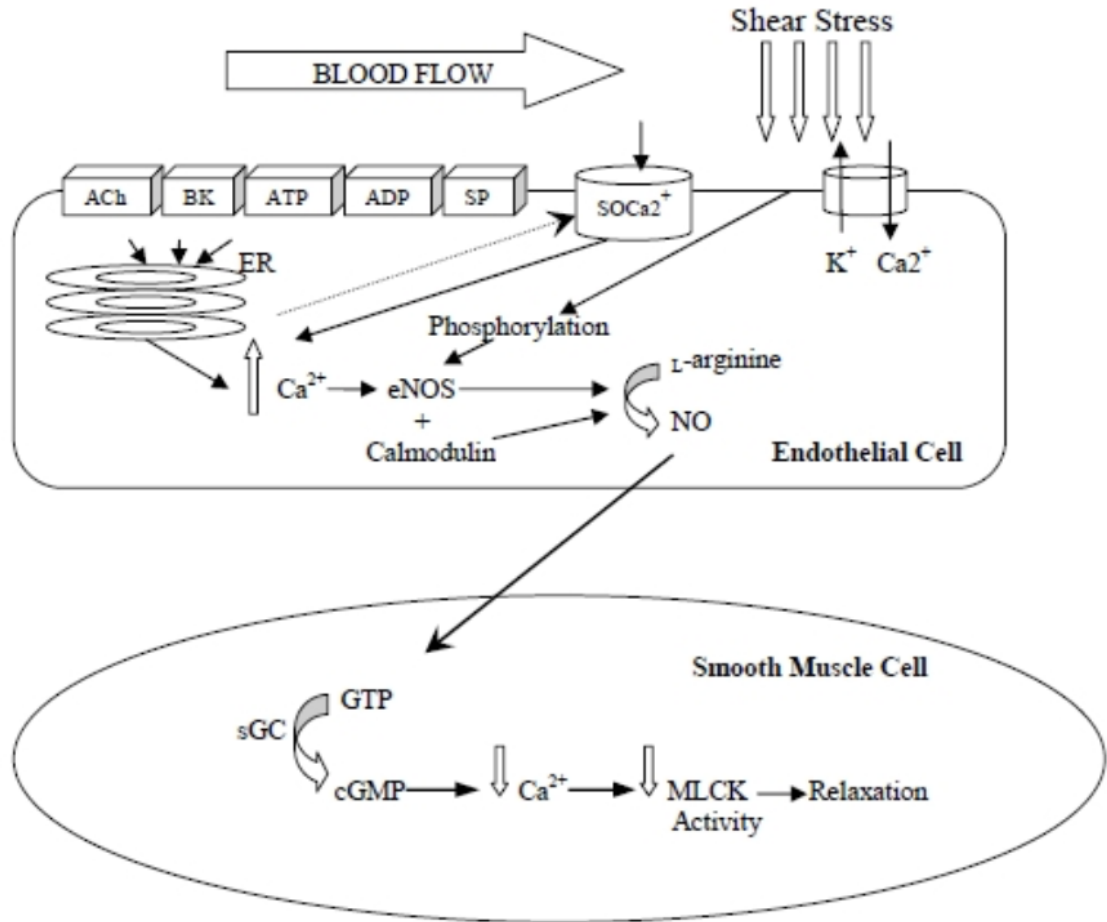

Figure 2.7. Nitric oxide (NO) production in the endothelium and the downstream effect on vascular smooth muscle relaxation through shear stress or blood-borne agonists; acetylcholine (ACh), bradykinin (BK), adenosine triphosphate (ATP), adenosine diphosphate (ADP), substance P. Shear stress or blood-borne agonists trigger an increase in intracellular calcium (Ca^{2+}) from the endoplasmic reticulum (ER) or receptor-operated channels (91). Calcium binds to calmodulin to simulate the activation of endothelial nitric oxide synthase (eNOS), which (91) converts the amino acid L-arginine into NO. The NO then diffuses into the vascular smooth muscle cell(91) where it binds to and activates the receptor enzyme soluble guanylyl cyclase (sGC). Soluble guanylyl cyclase converts guanosine triphosphate (GTP) into guanosine 3',5'-cyclic monophosphate (cGMP), which inhibits ER Ca^{2+} release and decreases myosin light chain kinase activity (MLCK) to cause relaxation (91).

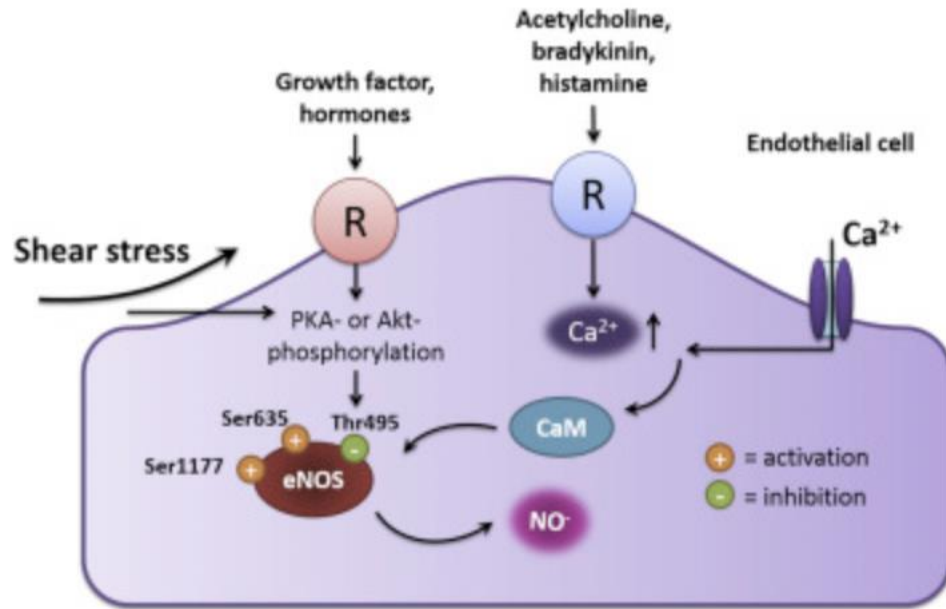

Figure 2.8. Calcium-independent and -dependent activation of endothelial nitric oxide synthase (eNOS). Shear stress induces phosphorylation of eNOS, which increases nitric oxide (NO) production via protein kinase A (PKA)-mediated phosphorylation of activation sites Ser635 or Ser1177(80). Agonists (acetylcholine, bradykinin, histamine) can also bind to receptors (R) to increase intracellular calcium (Ca^{2+}), creating a calcium-calmodulin complex (CaM) that activates eNOS to increase NO production (80).

Additionally, prostaglandins released from the endothelium also play a role in vasodilatory function. Cyclooxygenase enzymes catalyze the production of this agent by converting previously synthesized arachidonic acid into prostaglandin H_2 , which is then converted into prostacyclin via prostacyclin synthase (91). Prostacyclin binds to PGI receptors on vascular smooth muscle, which activates adenylate cyclase to increase cAMP synthesis. Cyclic AMP then activates protein kinase A (91), which phosphorylates Ser1177 and Ser635 on eNOS to augment NO production (80).

As well as the release of local vasodilators, the endothelium is also responsible for the release of the potent vasoconstrictor, endothelin-1. In contrast to the effects of NO, endothelin-1 increases vascular tone and is released in response to reduced shear stress (94). In response to decreased shear stress, preproendothelin-1 messenger RNA is

upregulated broken down to create big-ET-1 (95). Endothelin converting enzyme located on the membrane of the endothelial cell converts big-ET-1 to endothelin-1 (95). The binding of endothelin-1 to different receptors (i.e., ET_A, ET_B) exhibits differential effects (96). The binding of endothelin-1 to ET_B receptors, which are located on the endothelium, results in the clearance of endothelin-1 and stimulates eNOS enzyme activity and NO formation (96). The binding of endothelin-1 to the more dominant ET_A receptors, located on the vascular smooth muscle, stimulates the formation of inositol triphosphate from phosphatidylinositol biphosphate by phospholipase C (95). The increase of inositol within the vascular smooth muscle stimulates Ca²⁺ release to cause vasoconstriction (95). The impact of endothelin-1 on radial artery L-FMC responses has been investigated in younger adults via a post-occlusion hyperemia test following intra-arterial infusion of the ET_A antagonist BQ-123 (97). Following ET_A inhibition, radial L-FMC responses were blunted, while FMD responses remained unchanged, demonstrating the impact of endothelin-1 on L-FMC responses (97). Furthermore, resting blood flow increased following the administration of an ET_A antagonist, explaining the role of endothelin-1 in regulating basal vascular tone (97).

An index of endothelial EDHF, prostaglandin and endothelin-1 production can be assessed by quantifying L-FMC responses (see section 2.3.4 for details). Attenuated L-FMC responses have been demonstrated in the brachial, popliteal, and radial arteries following an oral administration of 150 mg fluconazole, which inhibits cytochrome P450 epoxygenase, preventing the production of the EDHF epoxyeicosatrienoic acid (44, 98). Furthermore, impaired L-FMC responses have been shown in the radial artery following a 500 mg oral administration of aspirin, a known cyclooxygenase inhibitor, and

preventing the production of prostaglandins (98). However, no changes in brachial or popliteal L-FMC responses were observed following the same dose of aspirin in young, healthy adults (44).

While the vasodilatory pathways of EDHFs and prostaglandins are provided for completeness, the present project will focus on the vasoactive effects of NO as the main outcome of endothelial function, given that reduced NO bioavailability is considered a central factor to the development of cardiovascular disease, but the vasoactive effects of EDHFs and prostaglandins will be investigated through brachial L-FMC responses to provide a more thorough assessment of endothelial-dependent function (44, 99).

2.3.5 – Role of Endothelial-Derived Nitric Oxide

Endothelial production of NO and the eventual relaxation of vascular smooth muscle is referred to as NO bioavailability and provides an index of both endothelial function (production) and vascular smooth muscle cell sensitivity (utilization) (80). While the present project will focus on the vasodilatory effects of NO, it is important to note that NO has other functions. Aside from the known vasodilatory functions, NO inhibits platelet aggregation and prevents thrombosis (100). Platelets play a key role in wound healing, but hyperreactivity can lead to vascular thrombosis or local coagulation (100). Nitric oxide plays a role in maintaining blood flow by keeping platelets inactive (100). Hyperreactivity and coagulation of platelets play a substantial role in the development of atherosclerosis, and the future development of CVD (100). Nitric oxide is an important factor in terms of peripheral and cerebral vascular health, and assessing its bioavailability can provide an index of endothelial and vascular smooth muscle health.

2.3.6 – Assessment of Brachial Endothelial-Dependent and -Independent Function

Endothelium-dependent NO bioavailability in conduit arteries can be assessed using the flow-mediated dilation (FMD) assessment (11), which represents the peak vasodilatory response to an induced hyperemia (i.e., increase in blood flow) and associated rise in shear stress (11). Lumen diameter and blood flow are measured via duplex ultrasonography at rest and following the period of distal ischemia (11). Specifically, the 12-minute FMD test consists of a 2-minute baseline period, followed by 5 minutes of distal ischemia, in which a pressure cuff is rapidly inflated to supra-systolic levels (250 mmHg) (11). An independent complementary outcome of endothelial-dependent function is the L-FMC response, which is assessed during this period of distal cuff inflation, by measuring the ischemic-induced reduction in arterial diameter (44). This assessment can provide information on the production and utilization of EDHFs, prostaglandins and endothelin-1, given their previously outlined role in L-FMC responses (44, 101). A second 5-minute recording period occurs following the release of cuff pressure, which provides the hyperemic stimulus (11). The ischemia-mediated increase in blood flow and shear stress stimulates endothelial production and release of NO to cause the vasodilatory response (11). A larger vasodilatory response is indicative of greater NO bioavailability and a healthier endothelium. The magnitude of the brachial FMD response provides prognostic information with respect to experiencing a future adverse cardiac event (12). Specifically, for every 1% increase in brachial FMD, there is a ~13% reduction in the relative risk of experiencing an adverse event (12).

In addition, an assessment of endothelial-independent vasodilation is typically conducted to determine whether the FMD response is related to endothelial NO production and/or bioavailability *per se* versus vascular smooth muscle cell sensitivity to

NO. Endothelial-independent vasodilation is routinely conducted via a sublingual spray of nitroglycerin, which provides a large exogenous dose of a NO-donor (102). Specifically, the nitroglycerin-mediated dilation (NMD) protocol involves a 1-minute baseline period of lumen diameter and blood flow recordings, the administration of a 0.4-mg sublingual dose of nitroglycerin, followed by an additional 10 minutes of duplex ultrasonography imaging. Nitroglycerin activates vascular smooth muscle sGC directly to produce a maximal vasodilatory response (102). A poor NMD response suggests a decreased sensitivity of the vascular smooth muscle cells to utilize NO, as opposed to the ability of the endothelium to produce NO (11, 102). Previous research has observed attenuated NMD responses in those with peripheral artery disease and coronary atherosclerosis (103). Attenuations in FMD and NMD responses may result in blunted vascular tone, an important factor in the control of blood pressure.

2.4 – Acute Control of Blood Pressure

The autonomic nervous system plays an important role in the regulation of blood pressure. Autonomic nerves and circulating hormones regulate cardiac and vascular functions involved in regulating blood pressure (87). Peripheral sensors (e.g., baroreceptors) have afferent nerve fibers that send information to the medullary cardiovascular control center, in which cell bodies for sympathetic and parasympathetic nerves are located to control the heart and vasculature (87). Baroreceptor afferent nerve fibers synapse on the NTS, where interneurons project to medullary regions to modulate vagal and sympathetic efferent activity (87). Specifically, parasympathetic vagal fibers innervate the sinoatrial node of the heart from cell bodies located in the dorsal vagal

nucleus and nucleus ambiguus (87). Afferent nerves from peripheral baroreceptors entering the NTS promote activation of these vagal nerves in response to increases in blood pressure, reducing sinoatrial node firing to slow heart rate (HR) and MAP, by the consequential reduction in cardiac output (CO) (87). To excite sympathetic activity from the RVLM, the NTS projects interneurons through the caudal ventrolateral medulla (CVLM) (87). The RVLM directly excites sympathetic preganglionic neurons in the intermediolateral nucleus in the thoracic and lumbar regions segments of the spinal cord (87). Postganglionic sympathetic fibers innervate the sinoatrial and atrioventricular nodes of the heart, increasing HR, and consequently, CO (87).

MAP, or the average arterial pressure throughout one cardiac cycle, is an important factor in the perfusion of organs and tissues (104). Mean arterial pressure is the product of CO, the quantity of blood pumped by the heart each minute, and total peripheral resistance (TPR), or the amount of force exerted on blood by the vasculature (104). Cardiac output is the product of HR and stroke volume (SV), while TPR is determined by the net amount of vasoconstriction (\uparrow TPR) versus vasodilation (\downarrow TPR) (104). Resting values of MAP typically range from 70 to 100 mmHg, with large fluctuations outside of the range having potentially disastrous effects (104). Decreases in MAP below 60 mmHg may result in neuronal death and insufficient blood flow, while increases in MAP above 100 mmHg may result in ventricular remodeling or stroke (104). Therefore, effective regulation of MAP to ensure proper perfusion is important.

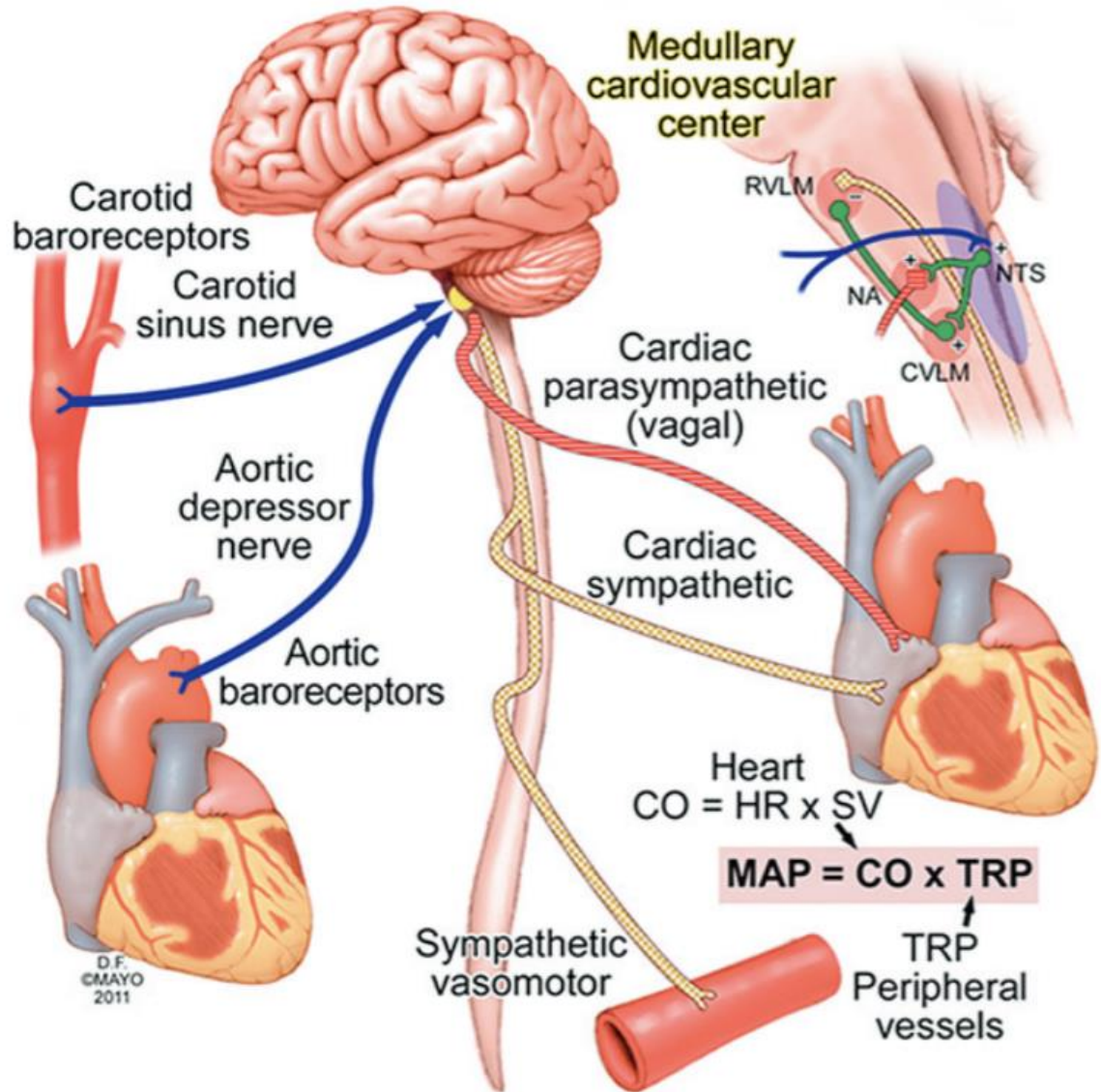

Figure 2.9. Sympathetic and parasympathetic (vagal) regulation of the heart and vasculature. Carotid and aortic baroreceptor afferent nerves carry information to the nucleus tractus solitarius (NTS) in the medullary cardiovascular control center. The NTS excites the RVLM to increase sympathetic activation of blood vessels and the heart, to increase total peripheral resistance (TRP), heart rate (HR), stroke volume (SV), and cardiac output (CO), promoting an increase in mean arterial pressure (MAP). The NTS sends excitatory interneurons to the nucleus ambiguus (NA) and the caudal ventrolateral medulla (CVLM) to increase parasympathetic activity to the heart. The CVLM inhibits the rostral ventrolateral medulla (RVLM), decreasing sympathetic activity (105).

2.5 – Overview of the Cerebrovascular System

2.5.1 – Control of Cerebral Blood Flow

Approximately 15% of resting CO is distributed to the brain due to its high metabolic requirements (86). Cerebral blood flow is distributed via posterior and anterior circulations (106). The posterior circulation is supplied by the bilateral vertebral arteries and accounts for approximately one-third of total CBF. It consists of the vertebral arteries, the basilar artery, and corresponding branches, which supplies blood to the medial temporal lobes, posterior section of the thalamus, occipital lobes, the brainstem, and the cerebellum (106). As the present project will assess red blood cell velocity in the middle cerebral artery (MCA), which is part of the anterior circulation, it will be the focus of this section. The anterior circulation originates in the bilateral internal carotid arteries (ICA), which branches into the anterior cerebral artery (ACA), the MCA and the anterior choroidal artery. The anterior circulatory system provides blood flow to the frontal, temporal and parietal lobes, and contributes ~72% of total CBF (106, 107). The ACA arises from the anterior portion of the ICA and courses anteromedially through the brain, breaking off into various deep branches along its course to perfuse the medial and superior portions of the frontal lobe, as well as the anterior parietal lobe (106). The anterior choroidal artery is a branch of the ICA that varies in anatomical origin but contains deep and superficial branches that perfuse the optic tract and medial temporal lobe (106). The MCA is the largest of the cerebral vessels, supplying critical structures of the brain (e.g., the frontal and temporal lobes) and is the most common site for ischemic stroke, indicating the importance of assessing this vessel (106). The MCA encompasses four main surgical segments (M1-M4) (108). The proximal segment (M1) originates from

the bifurcation of the ICA and passes laterally along the ventral surface of the frontal lobe, becoming the M2 segment, which either bifurcates or trifurcates, travels laterally, and perfuses the parietal lobe (106, 108). The M3 and M4 segments arise from M2 and extend to the most lateral surface of the brain, perfusing the frontal, parietal and temporal operculae (M3) and the hemispheric surface of the frontal and parietal lobes (M4) (106, 108). As indicated above, the MCA has clinical significance as it is the most common site of pathological damage and represents that cerebral artery of interest for the present project.

While these circulatory systems are comprised of differing structures and serve different functions, they are connected by an arterial ring, as a compensatory mechanism in the event of arterial occlusion (109). The circle of Willis refers to the structural arrangement of cerebral arteries (i.e., anterior communicating, ACA, MCA, posterior communicating, and posterior cerebral arteries) that provide a collateral blood flow route between the anterior and posterior circulations (110). The ring is connected by a single anterior communicating artery, which connects the bilateral ACAs (110). The ACAs run posterolateral until they reach a connection with the ICA, at which point the lateral continuation of the ICA becomes the MCA (110). At this same point of connection, the posterior communicating artery connects the MCA with posterior cerebral arteries, forming the furthestmost posterior aspect of the circle of Willis (110). The bilateral posterior cerebral arteries fuse, forming the basilar artery, which gives off many branches (i.e., superior cerebellar arteries, pontine arteries, anterior inferior cerebellar artery) (110). The basilar artery then divides into bilateral vertebral arteries, each giving rise to a

posterior inferior cerebellar artery and contributing to the single anterior spinal artery (Figure 2.10) (110).

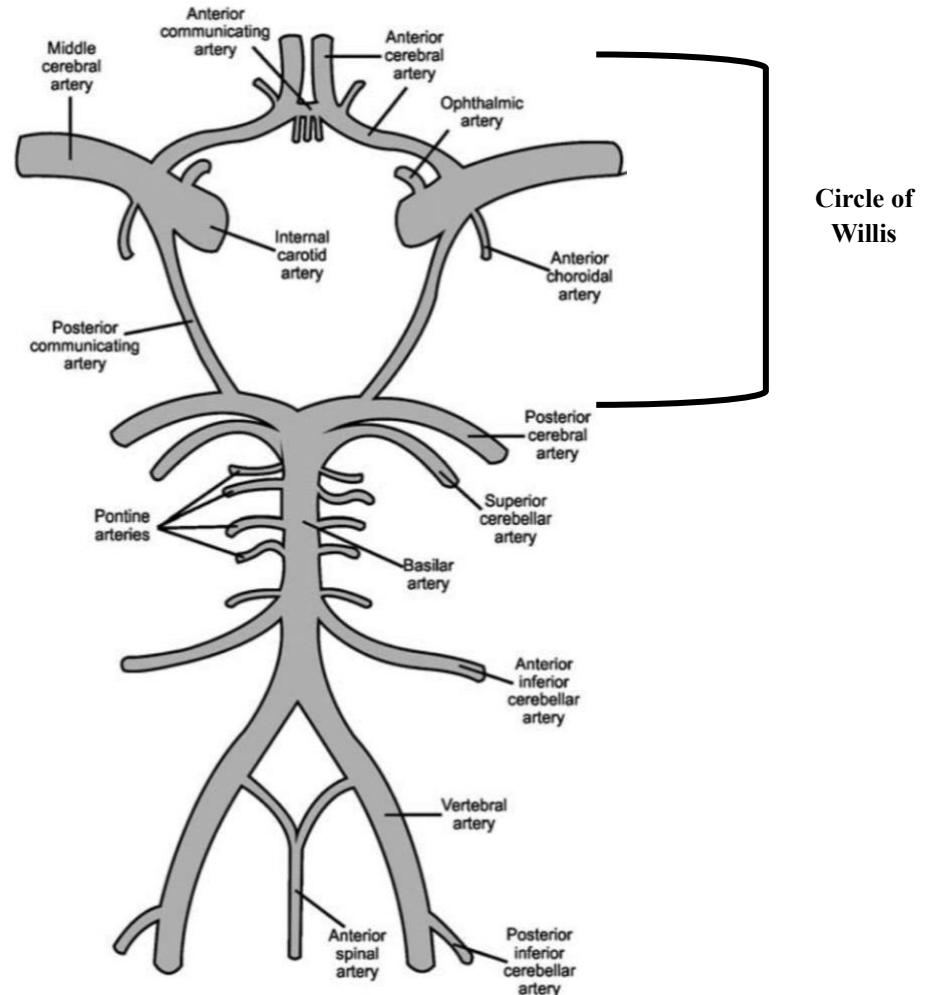

Figure 2.10. Anatomy of the cerebral arterial circulation. The internal carotid arteries are represented by short branches that give rise to small ophthalmic arteries before branching into the middle and anterior cerebral arteries. Bilateral anterior cerebral arteries are connected by the anterior communicating artery. The anterior spinal artery and the posterior inferior cerebellar artery continue into two vertebral arteries, which become the basilar artery. The anterior inferior cerebellar artery, superior cerebellar and pontine arteries branch from the basilar artery. The basilar artery branches terminally into the bilateral posterior cerebral arteries, which are connected by the posterior communicating artery to their respective internal carotid arteries. The connection of the posterior and anterior circulations by way of communicating arteries completes the circle of Willis (109). The middle cerebral artery branches off to distribute blood to its respective segments (M1-M4).

Cerebral arteries have a similar anatomical structure to systemic conduit arteries (111). Specifically, cerebral arteries and arterioles consist of the same three layers (*tunica intima*, *tunica media*, and *tunica adventitia*). However, the *tunica adventitia* of cerebral arteries/arterioles are composed of astrocyte end-feet, a type of glial cell important for the regulation of the blood-brain barrier (109). In contrast to systemic arteries, cerebral arteries lack an external elastic lamina but have a well-developed internal elastic lamina (53). Cerebral arteries are responsible for the delivery of oxygen and nutrients to the brain, as well as the removal of carbon dioxide and metabolic waste. At rest, the brain consumes ~20% of total oxygen consumption and ~50% of glucose consumption (86). Any blood flow disruptions will cause irreparable damage to brain function (86). In the systemic circulation, nutrient exchange occurs across the capillaries, where hydrophobic molecules (i.e., cholesterol, vitamins) diffuse through the endothelial membrane, and hydrophilic molecules (i.e., glucose, amino acids) diffuse through gaps between the endothelial cells (86). However, hydrophilic molecules are unable to diffuse across cerebral endothelial cells due to the presence of the blood-brain barrier. The blood-brain barrier is a physical barrier between the blood and cerebrospinal fluid composed of tight junctions between endothelial cells and held together by astrocytes (86). Substances that cannot cross the blood-brain barrier via diffusion rely on transport proteins to reach the blood vessels of the brain. For example, glucose is transported across the blood-brain barrier via glucose transport proteins (86). Cerebral blood flow is regulated by an intravascular pressure gradient between precapillary arterioles and postcapillary venules (112). Specifically, dilation of the arterioles increases this pressure gradient and flow to the capillaries (112).

Following the exchange of oxygen and nutrients in the capillary beds, cerebral blood rich with carbon dioxide enters the venous circulation (106). The cerebral venous system is divided into two sections, the superficial dural venous sinuses, and the deeper cerebral veins (113). Dural venous sinuses are endothelial-lined channels that collect blood from the cerebral veins and deliver it to the systemic venous circulation system (106, 113). However, the cerebral veins directly drain deoxygenated blood and are divided into superficial (cortical) and deep cerebral veins (106). The superficial cerebral veins remove deoxygenated blood from the cortex, while deep cerebral veins remove blood from the structures surrounding the lateral ventricles. The focus of the present project is on CBF, but a summary of venous outflow was included for a complete understanding of cerebral circulation.

The importance of optimal CBF regulation is well established, and resting CBF must remain relatively constant (106, 114). Cerebral blood flow is directly dependent on cerebral perfusion pressure [CPP, the difference between MAP and intracranial pressure (ICP)] and inversely proportional to cerebrovascular resistance (CBVR), or the level of resistance to blood flow in the cerebral vasculature, as represented by the equation below (19).

$$\mathbf{CBF = CPP/CBVR = (MAP-ICP)/CBVR}$$

CBF is mediated via four mechanisms: myogenic tone, neurogenic responses, endothelial, and metabolic mechanisms (19). Although the present project is interested in the assessment of the metabolic mechanism of CBF control, background information on each mechanism is included for completeness. Myogenic tone, or a state of vascular smooth muscle tone, is produced when arterial smooth muscle cells contract and relax in

response to increases and decreases in pressure, respectively (19). An increase in ICP results in vascular smooth muscle cell depolarization, which opens L-type Ca^{2+} -gated ion channels to permit the influx of extracellular calcium (19). The increase in intracellular Ca^{2+} optimizes the opportunity for the binding of Ca^{2+} with calmodulin to activate MLCK, increasing actin-myosin interactions to cause vasoconstriction (Figure 2.7).

Neurogenic mediation of CBF refers to the release of various vasoactive neurotransmitters from neurons or astrocytes that innervate the cerebral vasculature (19). While the specific mechanisms behind the control of the central nervous system on the cerebral vasculature are unclear and controversial, it is likely that the sympathetic nervous system is involved in the control of cerebral vessel diameters and blood flow (115). Acetylcholine is released by sympathetic preganglionic neurons, which bind to nicotinic-receptors (ligand-gated ion channels) located on postganglionic neurons (116). Upon binding, an influx of Ca^{2+} causes depolarization of the postganglionic neuron and subsequent release of norepinephrine that binds to adrenergic receptors, as highlighted previously in section 2.3.3 (Figure 2.5) (116). The cerebral vasculature is richly innervated by sympathetic nerve fibres. However, the precise role of sympathetic neural control of CBF remains poorly understood (117). Furthermore, a study by Ogoh et al. (118) found a moderate attenuation of CBF in response to a single, brief hypotensive stimulus when participants were administered an alpha-adrenergic receptor antagonist, suggesting that sympathetic control of CBF may be partially involved. Additionally, the cerebrovascular is densely innervated by parasympathetic cholinergic nerve fibres, but there is a paucity of human research to fully understand the magnitude of cholinergic control of CBF (119).

Endothelial-dependent mechanisms also play a role in the control of CBF (19, 120). Cerebral endothelial dysfunction is part of the pathophysiology of several neurological diseases, such as vascular dementia or the future onset of stroke (20). Cerebral blood flow is controlled by endothelial-derived vasoactive mediators (i.e., NO) and vasoconstricting agents (i.e., endothelin-1) (25). The mechanisms of the synthesis of vasodilators and vasoconstrictors in cerebral endothelial cells are similar to those in the systemic circulation (as described in sections 2.3.4 and 2.3.5). However, the location of cerebral vessels renders similar assessments (e.g., FMD) difficult (20, 121). Studies using animal models have investigated the impact of L-arginine, an amino acid essential to the synthesis of NO, as an outcome of cerebral endothelial function (20). Following the intravenous administration of L-arginine, increased vasodilation by the synthesis of NO through the catalytic reaction of eNOS, has been shown to cause an increase in CBF velocity, indicating a role of endothelium-derived NO in the control of CBF (20).

Metabolic control mechanisms, including changes in $P_a\text{CO}_2$, play a major role in the regulation of CBF (122). Increases in $P_a\text{CO}_2$ result in vasodilation of the cerebral vasculature, and an increase in CBF (123). The ability of the cerebral vessels to dilate in response to carbon dioxide, is an example of CVR (124). The opposite occurs in a state of hyperventilation, in which $P_a\text{CO}_2$ is substantially decreased, and cerebral vasoconstriction occurs (19). While the specific mechanisms are unknown, these responses may be attributed to the corresponding increase in arterial pH that is associated with decreased $P_a\text{CO}_2$, as an increased arterial pH is associated with vasoconstriction (125). Carbon dioxide-mediated cerebral vasodilation and a resultant increase in CBF may be stimulated by a shear stress-mediated release of vasodilatory agents (i.e., NO,

acetylcholine) (126). Links between endothelial-dependent vasodilatory function of systemic arteries and CVR have been reported, indicating a potential common pathway (22). A study in primates found that hypercapnia-mediated increases in CBF were blocked following an intraarterial injection of the NO synthase inhibitor L-NMMA, indicating the role of NO production in mediating the CVR response to elevated PaCO₂ (127). To assess CVR, an index of CBF must also be measured. For the current project, MCA red blood cell velocity will be assessed via TCD.

2.5.2 – Transcranial Doppler Assessment of MCA Velocity

Cerebral blood flow can be assessed directly or indirectly (128). Direct assessment of CBF involves measurement of arterial blood delivery to the capillaries via such techniques as single-photon emission computed tomography, positron emission tomography, magnetic resonance imaging with contrast agents, and arterial spin labelling (128). However, these methods are costly, and relatively invasive, which makes them impractical for many that must rely on more indirect methods. Indirect CBF measurement can be recorded via near-infrared spectroscopy, or TCD (128). Transcranial Doppler ultrasound cannot provide a direct measure of CBF, but rather measures red blood cell velocity (RBCv) (128, 129). The present project will use TCD to measure MCAv, as it provides real-time measures of cerebrovascular function, and has been used repeatedly to assess CVR (130–132).

This technique is based on the Doppler effect, in which ultrasound waves emitted from an ultrasound probe are transmitted through a window in the skull and reflected back to the probe by red blood cells in the cerebral artery of interest (133). The difference between emitted and reflected waves is directly proportional to the RBCv in the vessel

and is known as the “Doppler shift frequency” (133). The equation used to calculate the reflector speed, accounting for the Doppler shift can be expressed as follows:

$$\text{Red Blood Cell Velocity (cm/s)} = \frac{(\text{Doppler Shift}) \times \text{propagation speed}}{2 \times \text{incident frequency} \times \cos \theta}$$

As the vessel of interest in the present project is the MCA, a 2-MHz ultrasound probe will be positioned over the trans-temporal window to measure MCAv, using the equation above (Figure 2.11).

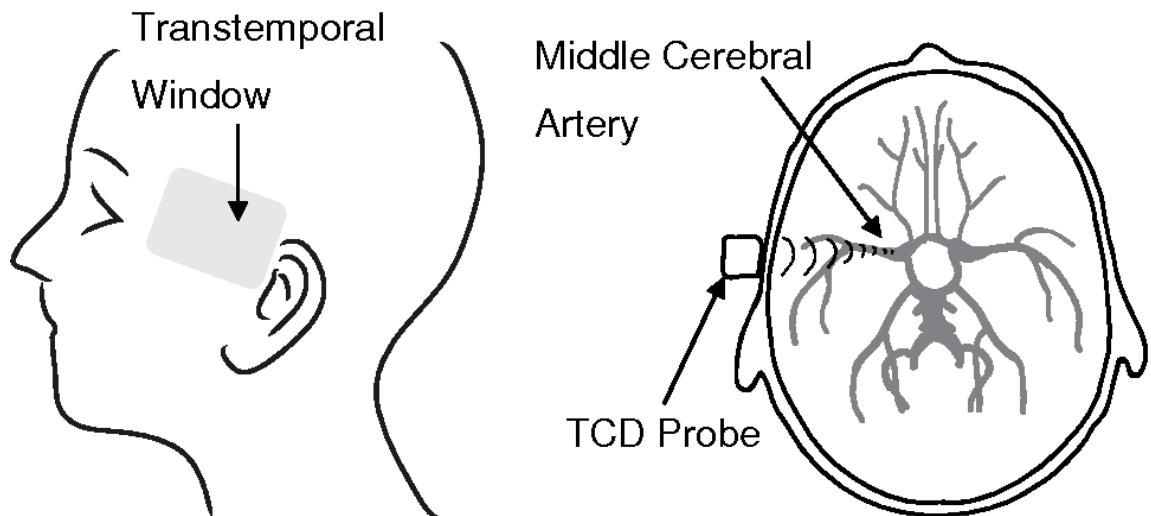

Figure 2.11. Identification of the transtemporal window and placement of a 2-MHz transcranial Doppler (TCD) probe to assess the middle cerebral artery.

2.5.3 – Assessment of Cerebrovascular Reactivity

Cerebrovascular reactivity refers to the change in CBF in response to a vasoactive stimulus (e.g., increase in $P_a\text{CO}_2$) (134). Cerebrovascular reactivity can be assessed using a repeated breath-hold protocol, in which $P_a\text{CO}_2$ rises, resulting in vasodilation of the cerebral arteries and a corresponding increase in CBF (135). The protocol used in the current study involves a series of 8, 20-second end-expiratory breath holds interspersed with 30 seconds of uncontrolled breathing while in a supine position. The first 2 breath-

holds will be used to familiarize participants with the protocol and not used in the quantification of CVR. Increases in the end-tidal partial pressure of carbon dioxide (ΔP_{ETCO_2}) will be quantified as the difference between the peak P_{ETCO_2} immediately following the breath-holds and the average of the last 2 normal breaths before each breath-hold (18, 26, 136). Cerebrovascular reactivity will be calculated as absolute and relative increases in MCAv relative to the corresponding rise in P_{ETCO_2} in both absolute ($\Delta MCAv / \Delta P_{ETCO_2}$ and $\% \Delta MCAv / \Delta P_{ETCO_2}$).

2.6 – Impact of Aging on Peripheral and Cerebral Vascular Function

There are numerous structural and functional changes to the vasculature with ageing, many of which lead to impaired endothelial function and contribute to the increased risk of developing CVD (137). Endothelial dysfunction can be characterized as an attenuated ability of the vasculature to dilate in response to physical or chemical stimuli and serves as an indicator of CVD risk (10). Ageing is associated with an increase in arterial lumen diameter, as well as the thickness of the intima-media layer (137). This causes a corresponding increase in the wall-to-lumen ratio, an index of vessel narrowing (137). Furthermore, ageing is associated with decreased elastin and increased in the arterial wall, leading to stiffening of peripheral and cerebral arteries (138). Furthermore, there is decreased endothelial-derived NO-bioavailability and vascular smooth muscle sensitivity to NO in older adults (10). This may be influenced by age-related increases in inflammation and oxidative stress acting on both the endothelium (i.e., synthesis) and the vascular smooth muscle (i.e., utilization) (139).

These age-related changes have been documented as attenuated FMD responses in older adults (137). In the endothelium, older adults have elevated asymmetric

dimethylarginine concentrations, a naturally occurring chemical in the blood that inhibits eNOS production of NO (140). This age-related elevated concentration of asymmetric dimethylarginine may be due to the increased production of reactive oxygen species, or oxidative stress that occurs with age (139). When reactive oxygen species are overproduced, superoxide pairs with NO, forming the highly reactive chemical peroxynitrite, which reduces the bioavailability of NO (139, 141). Older adults have demonstrated lower relative brachial FMD responses when compared with younger adults, as well as an impaired reactive hyperemic response (shear rate area under the curve, SR_{AUC}), the shear stress stimulus for FMD (13, 142).

Vasodilatory function and vascular health are also impacted by the sensitivity of the vascular smooth muscle to NO, as assessed by the NMD test (81). Vascular smooth muscle sensitivity to nitroglycerin declines with age in both conduit arteries and resistance vessels (143). Parker et al. (13) demonstrated that brachial NMD responses were ~50% lower in older adults compared to younger adults. Mechanisms associated with this age-related decline in vascular smooth muscle cell sensitivity to NO are unclear. However, there is some evidence from animal models to suggest there is an age-related decline in the concentration of soluble guanylyl cyclase (144, 145). This decrease in soluble guanylyl cyclase decreases cGMP production and reduces vascular smooth muscle relaxation (Figure 2.7) (144, 145). Furthermore, the age-related increase in reactive oxygen species may contribute to the decreased sensitivity of the vascular smooth muscle cells to NO in humans (146).

The proper perfusion of the brain is of key importance due to its high metabolic demand and constant need of oxygen and nutrients. Age is also a major risk factor for the

development of CBVD (147). Reduced CVR has been noted among older adults, which have been attributed to age-related impairments in the endothelial-dependent vasodilatory capacity of the cerebral vasculature (26, 27). A study by Lavi et al. (21) noted a reduced CVR response in patients with systemic endothelial dysfunction, which was hypothesized to be attributed to the age-related decline in CVR (21). Additionally, reductions in CVR with age are related to an increased risk of stroke and all-cause mortality (148). This age-related reduction in CVR is an early indication of abnormal cerebrovascular health (147). Although both CVR and CBF decrease with age, the specific mechanisms related to these decrements are still relatively unknown (149, 150).

2.7 – Impact of Aerobic Fitness on Vascular Function in Older Adults

The impact of aerobic fitness on preserving and improving peripheral arterial function during chronological aging are well established (33). In general, a 10% increase in $\dot{V}O_{2\text{peak/max}}$ is associated with a 1% higher relative brachial FMD response (34). Importantly, a 1% rise in relative FMD translates to a 13% reduction in the risk of experiencing an adverse cardiovascular event (8). Aerobic fitness has been associated with superior FMD responses in the brachial artery among older adults (151). Specifically, engaging in regular aerobic exercise enhances the bioavailability of NO, and attenuates the age-related decline in endothelial function by reactive oxygen species (152). A meta-analysis by Ashor et al. (34) determined that ≥ 4 weeks of aerobic exercise training can increase relative brachial FMD in older adults by $\sim 2.9\%$. Additively, a higher level of aerobic fitness has been associated with greater L-FMC responses in the brachial artery among older adults (153). A cross-sectional study reported a positive relationship

between $\dot{V}O_{2\text{peak}}$ and brachial FMD outcomes in healthy young/middle-aged males (154). Furthermore, O'Brien et al. (153) outlined that achieving 150 minutes of MVPA weekly is associated with higher brachial-FMD responses, highlighting that habitual activity is also an important factor in the brachial-FMD responses (155). Additionally, engaging in moderate-intensity continuous training (i.e., 30-minutes of moderate intensity physical activity per day, as per American College of Sports Medicine guidelines (156), has been associated with improved BA-FMD and $\dot{V}O_{2\text{peak}}$ (157).

Aerobic fitness has also been demonstrated to attenuate the age-related decline in cerebral vascular function (37, 38). A positive relationship has been demonstrated between $\dot{V}O_{2\text{peak}}$ and CBF in cross-sectional work (37, 38). Specifically, as shown by Ainslie et al. (37), aerobically trained males have an attenuated reduction in age-related MCAv. Additionally, a cross-sectional study compared CBF between Masters athletes (i.e., consistent age-group winners at regional and national endurance events for 23 ± 8 years), sedentary older adults, and a young control group (36). This study used MRI to demonstrate that Masters athletes had a higher CBF compared to both sedentary older adults and the young control group, indicating that lifelong aerobic training can increase CBF (Figure 2.10) (36).

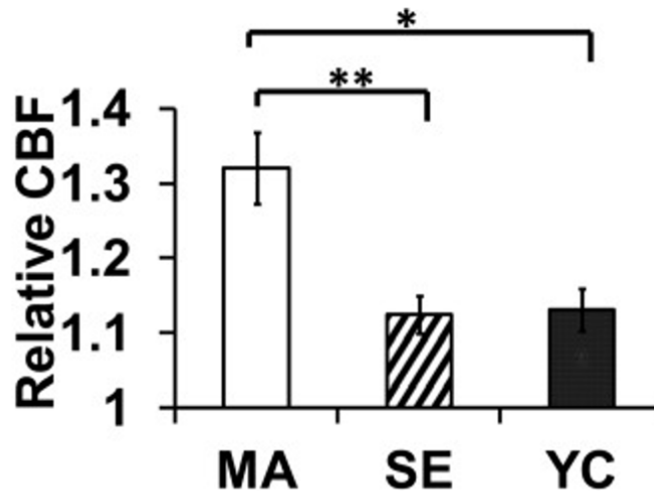

Figure 2.12 Comparison of resting relative cerebral blood flow (CBF) between Masters athletes (MA), sedentary elderly (SE), and young controls (YC). Data represented by means \pm standard deviations. *Corrected $p < 0.05$, **Corrected $p < 0.005$ (36).

Although there is consistent evidence that aerobic fitness increases CBF, conflicting evidence exists regarding the impact of aerobic fitness on CVR (36, 41, 42). Studies investigating this relationship have observed increased CVR in older adults with higher $\dot{V}O_2$ peak (42), while others have reported a lower (36, 41), or no effect (150). Specifically, using MRI to assess whole-brain CVR, Thomas et al. (36) observed a lower CVR in older adults with higher aerobic fitness and hypothesized this may have been due to a potential increase in P_aCO_2 during aerobic exercise, resulting in CO_2 desensitization in older adults who regularly engaged in aerobic exercise across their lifespan (36). Alternatively, using TCD to assess CVR in the MCA, Barnes et al. (42) demonstrated a positive correlation between $\dot{V}O_2$ peak and CVR (from the MCA) among older adults, but not among younger adults (Figure 2.12) (42). Of note, both studies utilized an inhaled higher CO_2 protocol (36, 42). A systematic review by Smith et al. (2021) demonstrated that a higher $\dot{V}O_2$ peak is associated with a higher CVR (50% of studies), as assessed by TCD or MRI in the MCA, among both younger and older adults (39).

Furthermore, DuBose et al. (43) looked at the relationship between CVR and $\dot{V}O_{2\text{peak}}$ in a large group of both middle-aged and older adults across a wide range of aerobic fitness (43). Using a breath-hold protocol to induce hypercapnia, they assessed CBF outcomes using BOLD-fMRI (43) and observed a negative relationship between CVR and aerobic fitness (43).

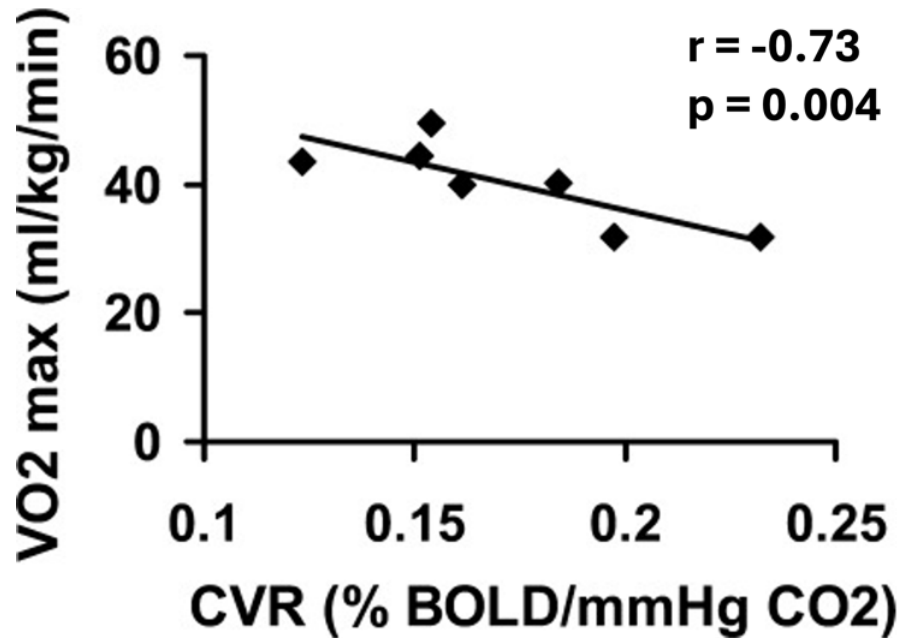

Figure 2.13. Example of a study demonstrating a negative association between aerobic fitness ($\dot{V}O_{2\text{peak}}$) and cerebrovascular reactivity (CVR). Maximal aerobic capacity was negatively associated ($r = -0.73$) with CVR in aerobically fit older adults (36).

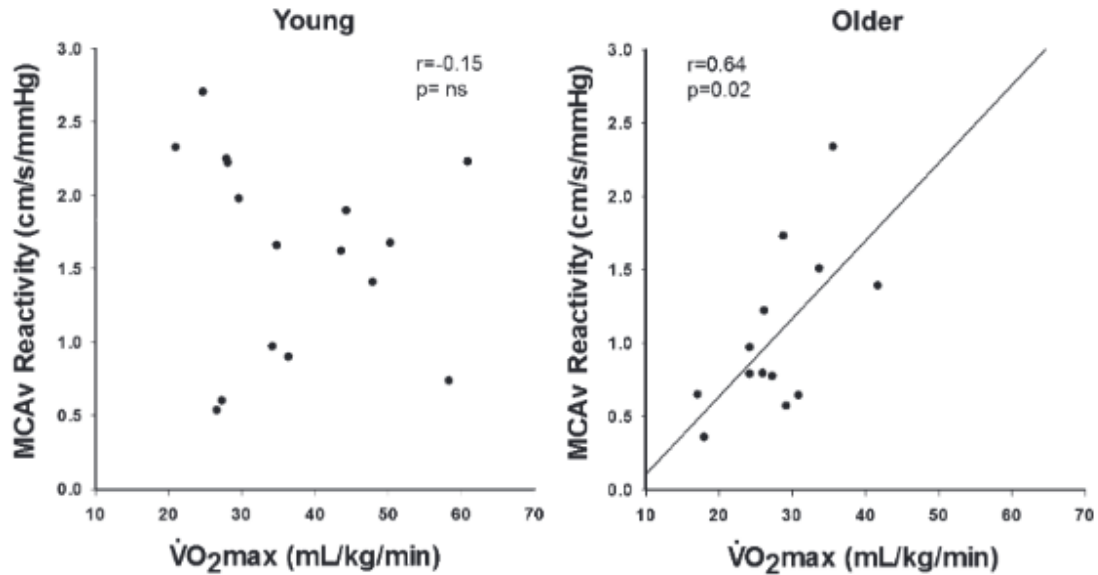

Figure 2.14. Example of a study demonstrating a positive association between aerobic fitness ($\dot{V}O_2\text{peak}$) and cerebrovascular reactivity (CVR). Maximal aerobic capacity was positively associated with CVR in the middle cerebral artery (MCA) in older adults ($r = 0.64$, $p = 0.02$), but not significantly different (ns) in younger adults ($r = -0.15$) (42).

Independently, the positive impacts of aerobic fitness on brachial-FMD (34, 151) and CBF (36, 38, 126) have been previously described. However, conflicting evidence exists regarding the relationship between aerobic fitness and the specific mechanisms that regulate CVR (36, 41, 42). The vascular function of the peripheral (e.g., brachial artery) and cerebral arteries (e.g., MCA) can be assessed by quantifying endothelial-dependent vasodilatory function, an important factor in the regulation of CVR, and the primary outcome of brachial-FMD (20, 25, 158).

However, as demonstrated by Carr et al. (23), endothelial-dependent CVR responses in the ICA are not related to CVR responses in the MCA, indicating potential differences in peripheral endothelial function and cerebral endothelial function (23). On the contrary, a study by Santos-Garcia et al. (159) demonstrated that lower FMD responses were associated with poor outcomes in patients with acute ischemic stroke,

highlighting that although differences in endothelial function between peripheral and cerebral arteries may exist, a potential relationship between peripheral FMD responses may also remain (159). As there is currently no direct methodology to assess endothelial function in the cerebral vessels, understanding the relationship between brachial artery endothelial function and vascular function of the cerebral vessels may provide further insight into these endothelial-dependent mechanisms of these vessels.

Furthermore, given the impact of aerobic fitness on peripheral endothelial function (151), understanding this relationship may also provide insight to how aerobic fitness impacts the endothelial function of the cerebral vessels.

2.8 – Purpose & Hypothesis

The objectives of the present study were to explore in younger and older adults whether: 1) aerobic fitness was related to resting MCAv, CVR, and/or brachial FMD, and 2) brachial FMD responses were associated with CVR. As indicated above, brachial FMD responses was the primary endothelial-dependent outcome of interest, but the relationships between aerobic fitness, CVR outcomes versus brachial L-FMC and NMD responses were also evaluated. It was hypothesized that aerobic fitness would be positively related to brachial FMD and resting MCAv. Considering the discrepancy in the existing literature, it was unclear whether aerobic fitness would be related to CVR responses. Furthermore, it was uncertain whether brachial endothelial-dependent outcomes would be related to CVR responses. As there was little evidence in the literature surrounding habitual physical and sedentary activity levels on cerebrovascular function, the relationships between these objectively measured outcomes (e.g., intensity-

based physical activity levels, sedentary time) on resting MCAv and CVR responses was also explored.

CHAPTER 3: METHODS

3.1 Participant Information

Participants were included if they were >18 years old, had a body mass index of <30 kg/m² (i.e., non-obese), were non-smokers (i.e., had not smoked nicotine or marijuana-containing cigarettes ≥ 4 days/week within the previous 6 months), were non-hypertensive [i.e., resting seated systolic blood pressure (SBP) < 139 mmHg and diastolic blood pressure (DBP) < 89 mmHg], had no history of orthostatic hypotension or fainting while standing, were not currently or had recently (i.e., the past 6 months) been prescribed medications that impact cardiovascular function (e.g. statins, sildenafil, on hormone replacement therapy), as well as females who were not pregnant or breastfeeding.

Thirty-three healthy (i.e., free from chronic disease) individuals (23♀) were recruited for this study. Four participants (3♀) were removed from the study due to an inability to obtain a stable TCD signal (n=1), syncope during data collection (n=1), a knee injury (n=1) and a dropout (n=1). As such, 29 participants completed the experimental protocol. Participants were stratified into younger (18-54 years) and older adults (≥ 55 years). There were 15 younger (11♀, 27 \pm 10 years) and 14 older participants (9♀, 67 \pm 9 years).

Participants were informed of all methods and procedures verbally and in writing prior to providing written informed consent. Premenopausal females were tested in the early-follicular phase of their natural menstrual cycle (i.e., Days 1-5 following the onset of menstruation), or during the placebo/inactive phase of oral combined contraceptive pill

use to minimize the influence of fluctuating hormonal levels on brachial endothelial function (160–162) (Naturally menstruating: n=2, Oral-contraceptives: n=9).

Participants abstained from moderate-vigorous physical activity (MVPA) for 24-hours, avoided foods high in saturated fats, caffeinated products, chocolate, citrus fruits, alcohol, and antioxidant supplements for 12 hours, and fasted for a minimum of 6-hours prior to data collection as these factors impact brachial endothelial function (11, 163). Height (to nearest 0.1-cm) and body mass (to nearest 0.1-kg) were collected via a calibrated stadiometer and physician's scale, respectively (Health-O-Meter, McCook II, USA). Body mass index was subsequently calculated. All protocols conformed to the Declaration of Helsinki, except for registration as a clinical trial, and were approved by the Dalhousie Health Sciences Research Ethics Board (REB# 2023-6585; Appendix A).

3.2 Experimental Measures and Analyses

3.2.1 –Assessment of Aerobic Fitness

Aerobic fitness was assessed using an incremental, maximal exercise test on an electromagnetically braked cycle ergometer (Lode Excalibur Sport, Groningen, The Netherlands). The ergometer seat was adjusted to a comfortable position while ensuring that a slight knee bend (~10-20 degrees knee flexion) was achieved at the lowest pedal position. Participants were equipped with a chest strap-based HR monitor (Polar H9, Kempele, FI) and a breathing mask or mouthpiece (with nose clip) attached to a commercial metabolic system (TrueOne 2400, Parvomedics Inc., Sandy, UT). The volume rates of oxygen consumption ($\dot{V}O_2$), and carbon dioxide production ($\dot{V}CO_2$) were collected, and the respiratory exchange ratio (RER, $\dot{V}CO_2/\dot{V}O_2$) calculated.

Once instrumented, participants were seated for at least 5 minutes to record resting HR and blood pressure via a semi-automatic vital signs monitor (Carescape v100, General Electric Healthcare). Participants then sat on the bike for 2 minutes to record resting $\dot{V}O_2$, $\dot{V}CO_2$ and RER, prior to beginning the warm-up period. Once resting measures were obtained, participants began a 5-minute warm-up period at a low intensity (30-50 watts). The workload was then increased to 1 watt/kg body mass and gradually increased by 15 watts per minute ($\sim 1W$ every 4 seconds) until voluntary exhaustion. Ratings of perceived exertion were assessed 1-3 minutes throughout the protocol using the Borg 6-20 scale (6 = no effort and 20 = maximal effort) (164). Strong verbal encouragement was provided throughout the testing period. The test was terminated when: a pedalling rate of 40 revolutions per minute could not be maintained for ≥ 15 -seconds, there was a sudden decrease in HR of >30 beats/minute, or when requested by the participant. Upon test completion, the intensity was reduced to the warm-up power output for a 5-minute cool-down period.

Heart rate, $\dot{V}O_2$, and RER were averaged every 15 seconds and maximum/peak values determined from the greatest consecutive 30-second average. The final workload achieved was recorded and considered as their peak aerobic power. The primary criterion for the attainment of a maximum $\dot{V}O_2$ was a plateau (i.e., an increase in absolute $\dot{V}O_2 \leq 150$ ml/min or relative $\dot{V}O_2 < 2.1$ ml/kg/min between successive 15-second averaged timepoints). In the absence of a plateau, a $\dot{V}O_{2peak}$ was ascribed if a participant achieved at least 2 of the following criteria: 1) a peak rating of perceived exertion score ≥ 18 , 2) a peak HR $\geq 95\%$ of age-predicted ($208 - 0.7 \times \text{age}$) (165), and 3) a peak RER ≥ 1.15 (165).

Considering that not all participants achieved a $\dot{V}O_{2max}$, the term $\dot{V}O_{2peak}$ will be used for the remainder of this thesis ($\dot{V}O_{2max}$: n=22, $\dot{V}O_{2peak}$: n=6, Unusable Data: n=1).

The primary metrics of aerobic fitness were absolute $\dot{V}O_{2peak}$ (L/min) and relative $\dot{V}O_{2peak}$ (ml/kg/min). However, for completeness, we also determined the percent of age-predicted $\dot{V}O_{2peak}$ (%), and the American College of Sports Medicine fitness percentile rank (%) (166). Age-predicted Absolute $\dot{V}O_{2peak}$ (L/min) was calculated from the following equation (Males = 0, Females = 1) (167):

$$[0.046 \times \text{height(cm)}] - [0.021 \times \text{age(years)}] - [0.62 \times \text{sex}] - 4.31$$

Furthermore, relative $\dot{V}O_{2peak}$ values were used to qualify aerobic fitness using the Canadian Society for Exercise Physiology – Physical Activity Training for Health estimated $\dot{V}O_{2max}$ Health Benefit Rating (Poor-Excellent) (168).

Finally, the ventilatory threshold was estimated automatically by the metabolic software using the V-slope method, VE threshold and ventilatory equivalent of oxygen, to which the average of the three methods were determined and expressed as a percentage of $\dot{V}O_{2peak}$ and reported for descriptive purposes. Furthermore, HR at the ventilatory threshold was presented (Table 4.1).

3.2.2 – Assessment of Habitual Activity

Habitual activity outcomes (i.e., physical, and sedentary activities) were objectively assessed by a thigh-positioned activPAL accelerometer and inclinometer (activPAL4, Pal Technologies Ltd. ®, Glasgow, UK) worn 24 hours per day for ~7 days. The activPAL was waterproofed using a nitrile finger cot and transparent medical adhesive (Tegaderm™, 3M, London, ON, Canada) secured to the midline of the right thigh, one-third of the way between the hip and knee (169). Participants completed a self-

report sleep log to help confirm activPAL-derived sleep versus sedentary time. As per recommendations for valid habitual activity data (169), only participants with a minimum 5 days of activPAL data were included for analysis (n=21). The activPAL data were analyzed using a customized MATLAB program (MATLAB 2020, MathWorks, USA) to quantify daily sedentary time, standing time, sleeping time, and step count. Further analyses were conducted using a customized LabVIEW program (LabVIEW 2020, National Instruments, Austin, TX, USA) to determine habitual light- (LPA), moderate (MPA), vigorous-intensity physical activity (VPA), using height-adjusted step-rate thresholds for younger adults (170), or BMI-adjusted step-rate thresholds for older adults (171).

3.2.3 – Measurement of Middle Cerebral Artery Red Blood Cell Velocity

Right MCAv was recorded via TCD (Multigon Industries Inc., Neurovision, Elmsford, NY, USA) using a 2-MHz probe positioned over the trans-temporal window and maintained in a steady position using a custom headset (Figure 3.1) (Multigon Neurovision, Elmsford, NY, USA). The MCAv signal was identified and recorded according to standardized criteria guided by signal depth and velocity (172). Ultrasound power was set ‘as low as reasonably achievable’ to avoid unnecessarily high exposure to participants (173). The optimal signal depth, sample volume, and power remained constant throughout the testing session. The MCAv signal was recorded at 400 Hz using a dedicated data acquisition system (PowerLab, ADInstruments) and analysis software (Lab Chart v8, ADInstruments).



Figure 3.1. Schematic view of the transcranial Doppler 2-MHz probe over the trans-temporal window, secured with a custom headset.

3.2.4 - Assessments of Resting Cardiovascular Function & Cerebrovascular Reactivity

All resting cardiovascular and CVR-related outcomes were recorded with participant in the supine position. Continuous HR was calculated from successive cardiac intervals obtained from lead II of a standard bipolar electrocardiographic recording. Beat-by-beat measurements of SBP and DBP were recorded using non-invasive finger photoplethysmography (Finometer Model 2; Finapres Medical Systems, Amsterdam, The Netherlands). The electrocardiogram (1000 Hz) and Finometer (200 Hz) recordings were sampled continuously on a dedicated data acquisition system (PowerLab, ADInstruments) and analysed offline using LabChart software (Version 8, ADInstruments, Sydney, Australia). Finally, participants were fitted with a facemask (7450 Series Silicone V2 Oro-Nasal Mask, Hans Rudolph) attached to a commercial gas analyzer (ADInstruments, Sydney, Australia) for the continuous determination of breath-by-breath expired O₂% and CO₂% (both sampled at 20 Hz), as well as a respiratory belt (ADInstruments, Sydney, Australia), to confirm breaths during analysis.

A 'physiological calibration' of the Finometer blood pressure waveform was performed using the average of 2-3 consistent brachial SBP and DBP values recorded from a semi-automated vital signs monitor (Carescape v100, General Electric Healthcare, Mississauga, ON, Canada). Finometer-derived SBP and DBP values were determined as the maximum and minimum within beat values, respectively. Mean arterial pressure was calculated as $\frac{1}{3}\text{SBP} + \frac{2}{3}\text{DBP}$. An index of cerebrovascular resistance was calculated as $\text{MAP}/\text{Mean MCAv}$. Cerebrovascular reactivity can be quantified by the rise in MCAv (from resting values) following an increase in PaCO_2 and/or PETCO_2 (174). PETCO_2 was calculated from the $\% \text{CO}_2$ using the following equation:

$$\text{PETCO}_2 = \text{FETCO}_2 \times \text{Barometric Pressure (mmHg)}$$

Once stable signals were attained, baseline recordings were performed for ~5-minutes while breathing spontaneously (i.e., at their natural rate) before starting the assessment of CVR. For this project, CVR was assessed using the previously validated repeated end-expiratory breath hold protocol to elicit increases in both MCAv and PETCO_2 (18, 26, 136). This protocol began with 30-seconds of paced breathing (16 breaths/minute) guided by an auditory metronome. Participants held their breath for 20 seconds at the end of a normal expiration, followed by a forced exhalation to empty the air from their lungs. An additional 30-second paced breathing period followed. This pattern was repeated until the participant completed a total of 8 breath holds. Peak PETCO_2 values were determined following each breath hold and subtracted from the average of the last 2 breaths before each apnea (18, 26, 136). The MCAv and PETCO_2 responses to the final 6 breath holds were averaged (18, 26, 136). The first 2 breath holds were used to familiarize participants with the task (18). Cerebrovascular reactivity was

then calculated as both absolute ($\Delta\text{MCAv}/\Delta P_{\text{ETCO}_2}$, cm/s/mmHg) and relative to the MCAv during the last two breaths of the previous paced breathing phase ($[\Delta\text{MCAv}/\text{MCAv during paced breathing}]/\Delta P_{\text{ETCO}_2}$), %cm/s/mmHg) responses (18, 26, 136).

3.2.5 – Assessments of Brachial Artery Function

3.2.5.1 Flow-Mediated Dilation

Brachial artery endothelial-dependent dilation was assessed using the FMD technique with participants in the supine position. The brachial artery was imaged ~3-5cm proximal to the antecubital fossa using a 12-MHz multi-frequency linear array probe attached to a high-resolution duplex ultrasonography machine (Vivid i, General Electric Healthcare, Mississauga, ON, Canada). A water-based conductive gel was spread over the surface of the skin at the location of probe placement. Brightness and frequency were adjusted for each participant to obtain the optimal image. Red blood cell velocity was continuously recorded using a pulsed frequency of 5-MHz and an insonation angle corrected to 60° that remained constant throughout the study. Video signals from the ultrasound machine were recorded simultaneously on a laptop via a video graphics array converter (Epiphan Systems Inc., VGA 2 USB, Ottawa, ON) for offline analysis (Cardiovascular Suite, Quipu). The sample volume for RBCv was adjusted for each participant to ensure both superior and inferior edges of the lumen are included in measurement (11).

A pressure cuff attached to a rapid inflation system (E20 and AG101, Hokanson®, Bellevue, WA) was placed distally, on the widest circumference of the forearm. Pressure cuff and probe placement are illustrated in Figure 3.2. Participants remained supine for

~10 minutes to induce a rested state. Resting lumen diameter and RBCv were measured for 2-minutes to determine baseline measurements. Following the baseline measurement period, the pressure cuff was rapidly inflated to 250 mmHg for 5 minutes, then rapidly deflated. Lumen diameter and RBCv were continuously measured throughout the cuff inflation period, as well as for an additional 5 minutes following cuff deflation to identify the peak lumen diameter.

Brachial lumen diameter, RBCv and shear rate (SR) were calculated using commercial edge detection and wall-tracking software (Cardiovascular Suite, Quipu). Resting diameter and RBCv were averaged from the 2-minute baseline period. Brachial blood flow was calculated as $[\pi \times \text{lumen radius}^2 (\text{cm}^2) \times \text{RBCv} (\text{cm/s}) \times 60 (\text{s/min})]$ and SR (/s) as $[(8 \times \text{RBCv} (\text{cm/s}) / \text{arterial diameter} (\text{cm}))]$. Absolute L-FMC (mm) was quantified during the final 30-seconds of the distal ischemic period, as $[(\text{nadir diameter}) - (\text{baseline diameter})]$, while relative L-FMC (%) was calculated as $[(\text{nadir diameter} - \text{baseline diameter}) / \text{baseline diameter} \times 100\%]$

Absolute FMD (mm) was quantified as $[(\text{peak diameter}) - (\text{baseline diameter})]$, while relative FMD (%) was calculated as $[(\text{peak diameter} - \text{baseline diameter}) / \text{baseline diameter} \times 100\%]$. The time-to-peak dilation (s) was recorded. The stimulus for the FMD response, or the SR area under the curve (SR_{AUC}), is determined between the start of cuff deflation to the time that peak dilation occurred. To minimize interindividual vasodilatory responses to reactive hyperemia, normalized FMD is recommended if the following statistical assumptions are met: 1) the relationship between FMD and SR_{AUC} is linear (i.e., $p < 0.05$), and 2) the intercept for the regression slope is zero (175, 176). The statistical assumptions were not met, and SR_{AUC} normalization of FMD was not required.

Should interindividual differences in brachial artery diameter impact the magnitude of the FMD response, allometric scaling can be applied (177). If the linear relationship between the logarithmically transformed peak and baseline diameters produces an unstandardized β -coefficient that deviates from 1, and yields an upper 95% CI < 1 , allometric scaling can be applied to take into consideration these interindividual differences (177). Allometric scaling was not used given the unstandardized β -coefficient did not deviate from 1 ($\beta=0.988$, 95%CI: 0.953-1.024).

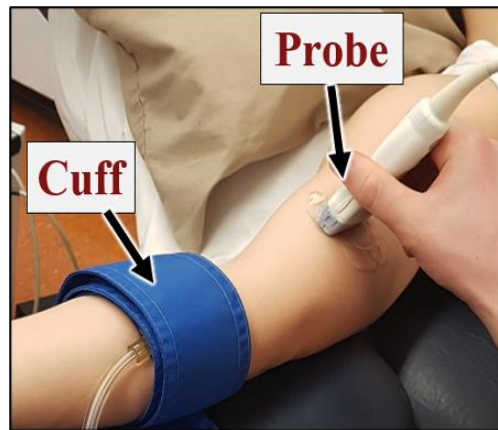

Figure 3.2. Brachial artery assessment of low-flow-mediated constriction and flow-mediated dilation. The ultrasound probe was positioned ~3-5cm proximal to the antecubital fossa and the pressure cuff placed distally around the largest circumference of the forearm.

3.2.5.2 Nitroglycerin-Mediated Dilation

After completing the FMD assessment, participants remained in a supine position for ~10 minutes to ensure lumen diameter and RBCv returned to baseline levels before the assessment of endothelial-independent vasodilation was initiated. Baseline lumen diameter and RBCv were assessed for 1-minute before a 0.4 mg sublingual dose of nitroglycerin was administered. Artery diameter and RBCv were continuously measured for 10 minutes following nitroglycerin administration. Brachial NMD was quantified as

both the absolute (Δ mm) and relative (%) increase in peak diameter (from baseline) observed following nitroglycerin administration.

3.3 – Experimental Design

All assessments were conducted in a thermoneutral room ($\sim 21^{\circ}\text{C}$) over the course of 2-3 laboratory sessions. Participants completed either the brachial artery assessments or the CVR protocol on the first visit, the order of which was randomly assigned. The protocols not performed during the first session were completed during a subsequent visit. At the end of the second visit, participants had the option to complete the aerobic fitness protocol or to come back on a third visit to complete it. Following completion of the aerobic fitness protocol, participants were instrumented with the activPAL monitor (activPAL4, Pal Technologies Ltd. ®, Glasgow, UK).

3.4 - Statistical Analysis

All data were assessed for normality using a Shapiro-Wilk test. Non-parametric tests were used if the data were not normally distributed (i.e., age, absolute $\dot{V}\text{O}_2\text{peak}$, LPA, absolute CVR, relative CVR, relative FMD, relative NMD, relative L-FMC).

Participant characteristics, habitual activity, aerobic fitness, systemic hemodynamics, brachial, and CVR outcomes were compared between younger and older adults using independent samples *t*-tests as an exploratory outcome (non-parametric: Mann-Whitney U-tests). To test the first objective of the study, the relationship between aerobic fitness (i.e., absolute $\dot{V}\text{O}_2\text{peak}$, relative $\dot{V}\text{O}_2\text{peak}$) vs resting MCAv, CVR and/or BA-FMD/NMD, Pearson's correlation analyses (non-parametric: Spearman correlation) were conducted on the whole cohort. All assumptions of Pearson's correlation were assessed (i.e., continuous scale, normally distributed, linearly related, no outliers (i.e.,

more than 3 standard deviations away from the mean). When age was not considered directly in a variable included in the correlation (i.e., Age-Predicted VO₂ peak), a partial correlation was used with age included as a co-variate.

For the second objective, the relationships between BA-FMD/NMD and CVR outcomes were assessed in the entire cohort by Pearson's or Spearman's correlation analysis. Furthermore, I explored relationships between habitual activity on cerebrovascular (i.e., MCA_v, absolute CVR, relative CVR) and brachial artery outcomes (i.e., FMD, L-FMC, NMD) via Pearson's or Spearman's correlation analyses, as well as assessed the impact of ageing on brachial and cerebral arterial outcomes via independent t-tests between groups. All statistical analyses were performed using SPSS software (Version 28, IBM Corp., Armonk, NY, USA). The level of significance was set at $P < 0.05$. All data were expressed as means \pm standard deviations.

CHAPTER 4: RESULTS

4.1 Participant Characteristics

All participant descriptive characteristics, aerobic fitness outcomes and habitual activities are presented in Table 4.1. No height, weight, or body mass index differences were noted between groups (all, $p > 0.591$).

No between-group differences existed for peak RER, peak RPE, peak aerobic power, peak METs, absolute $\dot{V}O_{2peak}$, ACSM fitness percentile, and ventilatory threshold (all, $p > 0.088$). Younger adults had a higher peak HR ($p < 0.001$) and HR at the ventilatory threshold ($p = 0.049$), as well as greater age-predicted absolute $\dot{V}O_{2peak}$ ($p = 0.022$), and relative $\dot{V}O_{2peak}$ ($p = 0.049$) (Table 4.1). However, older adults had a larger percent of age-predicted $\dot{V}O_{2peak}$ ($p = 0.025$) (Table 4.1).

No between-group differences were observed in sedentary time (hours/day), standing time (mins/day), sleep time (hours/day) or step count (steps/day) (all $p > 0.184$). However, older adults performed more weekly LPA ($p = 0.015$) and younger adults achieved a higher amount of weekly MVPA ($p = 0.050$).

Table 4.1. Participant descriptive characteristics, aerobic fitness and habitual activity outcomes.

	Cohort	Younger Adults	Older Adults	p-values
Descriptive Characteristics				
Participants	29 (20♀)	15 (11♀)	14 (9♀)	-
Age (years)	46±21 (20-83)	27±10 (20-50)	67±9 (55-83)	<0.001
Height (cm)	170.1±10.3 (147.0-193.3)	169.9±9.3 (157.1-191.2)	170.3±11.6 (147.0-193.3)	0.911
Weight (kg)	72.3±15.0 (49.9-108.8)	70.8±15.4 (49.9-104.4)	73.8±15.0 (53.3-108.8)	0.607
Body Mass Index (kg/m ²)	24.9±3.9 (20.1-34.7)	24.4±3.8 (20.1-31.2)	25.4±4.0 (20.7-34.7)	0.591
Aerobic Fitness				
Peak HR (beats/min)	177±19 (130-205)	187±12 (170-205)	164±18 (130-194)	<0.001
Percent Age-Predicted HR (%)	100±8 (86-125)	99±6 (87-111)	101±10 (86-125)	0.407
Peak RER (VCO ₂ /VO ₂)	1.23±0.16 (1.01-1.64)	1.24±0.15 (1.08-1.63)	1.22±0.17 (1.01-1.64)	0.618
Peak RPE	19±1 (16-20)	19±1 (16-20)	19±1 (16-20)	0.088
Peak Aerobic Power (watts)	221±91 (88-432)	240±25 (138-432)	199±22 (88-336)	0.316
Absolute $\dot{V}O_{2peak}$ (L/min)	2.49±1.0 (1.17-5.15)	2.72±1.04 (1.69-5.15)	2.23±0.86 (1.17-3.76)	0.170
Age-Predicted $\dot{V}O_{2peak}$ (L/min)(9)	2.14±0.16 (0.46-3.85)	2.47±0.64 (1.33-3.85)	1.75±0.87 (0.46-3.29)	0.022
Percent Age-Predicted $\dot{V}O_{2peak}$ (%)	126±44 (77-255)	111±33 (77-188)	142±51 (97-255)	0.025
Relative $\dot{V}O_{2peak}$ (ml/kg/min)	34.1±10.2 (15.6-65.5)	38.1±9.5 (26.7-65.5)	29.4±9.4 (15.6-43.6)	0.049
CSEP Fitness Category	Poor (Poor-Excellent)	Poor (Poor-Excellent)	Poor (Poor-Excellent)	-
ACSM Fitness Percentile (%)	40±30 (1-99)	41±31 (1-99)	40±31 (1-95)	0.949
Ventilatory Threshold (% $\dot{V}O_{2peak}$)	66±9 (42-78)	67±7 (54-77)	64±11 (42-78)	0.292
HR at VT (beats/min)	146±26 (84-192)	155±21 (114-192)	135±28 (84-191)	0.049
Habitual Activity				
Sedentary Time (hours/day)	11.3±2.4 (7.1-16.0)	12.2±1.8 (9.0-15.3)	10.2±2.7 (7.1-16.0)	0.184
Standing Time (hours/day)	6.1±1.5 (4.0-8.2)	5.7±1.3 (4.0-8.2)	6.6±1.6 (4.1-8.2)	0.201
Sleeping Time (hours/day)	8.5±1.0 (6.7-10.5)	8.7±1.0 (7.3-10.5)	8.4±1.0 (6.7-9.9)	0.516
Step Count (steps/day)	11428±3114 (5891-15760)	11388±2743 (7454-15657)	11481±3727 (5891-15760)	0.951
LPA (mins/week)	477±163 (222-859)	402±89 (222-520)	575±191 (365-859)	0.015
MVPA (mins/week)	240±95 (54-389)	269±81 (93-381)	202±103 (54-389)	0.050

Data are presented as means±standard deviations. CSEP Fitness Categories were determined by the mode for the group. $\dot{V}O_{2peak}$, peak volume rate of oxygen consumption; CSEP, Canadian Society for Exercise Physiology; ACSM, American College of Sports Medicine; HR, heart rate; RER, respiratory exchange ratio; $\dot{V}CO_2$, volume rate of carbon dioxide production; RPE, rating of perceived exertion; VT, ventilatory threshold; LPA, light-intensity physical activity; MVPA, moderate-to-vigorous physical activity. Between-group differences assessed via independent samples t-tests or Mann-Whitney U tests. Equation used for age- and sex-related prediction of absolute $\dot{V}O_{2peak}$ sourced from (167).

Table 4.2. Resting systemic and cerebral hemodynamics, as well as cerebrovascular reactivity outcomes between age groups.

	Cohort	Younger Adults	Older Adults	p-value
Resting Systemic Hemodynamics				
Heart Rate (beats/min)	62 ± 10 (45-85)	67 ± 9 (56-85)	57 ± 9 (45-71)	0.007
Systolic Blood Pressure (mmHg)	122 ± 8 (96-137)	118 ± 9 (96-131)	126 ± 6 (118-137)	0.015
Diastolic Blood Pressure (mmHg)	70 ± 8 (52-85)	69 ± 8 (55-80)	70 ± 9 (52-85)	0.867
Mean Arterial Pressure (mmHg)	82 ± 8 (63-97)	81 ± 8 (66-96)	83 ± 9 (63-97)	0.390
Resting Cerebral Hemodynamics				
MCAv (cm/s)	55 ± 20 (18-89)	65 ± 11 (51-86)	40 ± 22 (18-89)	0.003
P _{ET} CO ₂ (mmHg)	39 ± 5 (30-54)	40 ± 6 (31-54)	38 ± 4 (30-45)	0.343
Cerebrovascular Resistance (mmHg/cm/s)	1.8 ± 1.0 (0.8-4.7)	1.3 ± 0.3 (0.9-1.8)	2.6 ± 1.2 (0.8-4.7)	0.009
Cerebrovascular Reactivity (CVR)				
Peak MCAv (cm/s)	72 ± 25 (31-118)	85 ± 22 (50-118)	56 ± 20 (31-98)	0.002
Peak P _{ET} CO ₂ (mmHg)	42 ± 5 (29-51)	43 ± 4 (37-51)	41 ± 6 (29-48)	0.687
Peak MAP	97 ± 8 (85-109)	96 ± 8 (85-108)	98 ± 8 (92-109)	0.466
Absolute CVR (cm/s/mmHg)	3.8 ± 2.9 (1.1-12.2)	5.2 ± 3.2 (1.1-12.2)	2.0 ± 0.7 (1.1-3.7)	0.004
Relative CVR (%cm/s/mmHg)	7.4 ± 4.6 (2.4-23.9)	8.9 ± 5.6 (2.4-23.9)	5.4 ± 1.8 (3.1-8.8)	0.075

Data presented as means±standard deviations. P_{ET}CO₂, partial pressure of end-tidal carbon dioxide; MCAv, middle cerebral artery red blood cell velocity. Absolute CVR was calculated as the change in MCAv divided by the change in P_{ET}CO₂ from paced breathing to breath hold. Relative CVR was calculated as the percent change in MCAv relative to paced breathing divided by the change in P_{ET}CO₂ from paced breathing to breath hold. Between-group differences assessed via independent samples t-tests or Mann-Whitney U tests.

4.2 Resting Systemic Hemodynamics & Cerebrovascular Outcomes

All hemodynamic variables are outlined in Table 4.2. Both groups had similar DBP and MAP ($p>0.390$). Younger adults had a higher resting HR ($p=0.007$) and lower SBP compared to older adults ($p=0.015$).

Furthermore, younger adults had a higher resting MCAv ($p=0.003$) and lower CBVR ($p=0.009$) compared to their older peers. Resting P_{ETCO_2} was similar between groups ($p=0.343$).

During the breath hold protocol, younger adults had a higher peak MCAv ($p=0.002$), but no differences were observed between groups for peak P_{ETCO_2} ($p=0.687$). There were no between-group differences observed for the peak MAP response ($p=0.466$). Finally, absolute CVR was higher in younger adults ($p=0.004$) with no differences observed for relative CVR ($p=0.075$).

4.3 Relationships Between Aerobic Fitness & Habitual Activity Versus Cerebrovascular Outcomes

The relationships between absolute and relative $\dot{V}O_{2peak}$ versus resting MCAv, peak MCAv and CVR responses are presented in Figure 4.1. No significant relationships were observed between either metric of aerobic fitness versus any of the cerebrovascular outcomes (all, $p>0.179$). The relationship between absolute and relative $\dot{V}O_{2peak}$ versus relative CVR is outlined in Supplemental Figure 1. In contrast, significant relationships were observed between the percent of age-predicted $\dot{V}O_{2peak}$ versus resting MCAv ($p=0.033$) and absolute CVR ($p=0.030$) (Supplemental Figure 2A & B). No relationship was observed between the percent of age-predicted $\dot{V}O_{2peak}$ and relative CVR ($p=0.330$) (Supplemental Figure 2C). No relationship existed between the ACSM percentile rank

(%) versus resting MCAv ($p=0.932$) (Supplemental Figure 2D), absolute CVR ($p=0.395$) (Supplemental Figure 2E) or relative CVR ($p=0.257$) (Supplemental Figure 2F). There were no relationships between CSEP Fitness Category and resting MCAv ($p=0.279$) (Supplemental Figure 2G), absolute CVR ($p=0.095$) (Supplemental Figure 2H), or relative CVR ($p=0.284$) (Supplemental Figure 2I). Further, the relative VO_2 peak was positively correlated with resting P_{ETCO_2} ($p<0.001$).

Outcomes of habitual activity (i.e., sedentary time, LPA, MVPA) were not associated with any outcome of cerebrovascular regulation (i.e., resting MCAv, absolute CVR, relative CVR) (all, $p>0.152$). No relationships were significant when run separately in each age group (all, $p>0.112$).

4.4. Brachial Artery Function Outcomes

All resting brachial artery hemodynamics were similar between age groups (all, $p>0.43$) and presented in Table 4.3. No between-group differences were observed in brachial FMD outcomes (i.e., peak diameter, absolute FMD, relative FMD, time-to-peak, SR_{AUC}) (all, $p>0.16$).

Absolute NMD responses were higher in older adults compared to younger adults ($p=0.015$), but relative NMD ($p=0.118$) and peak diameter ($p=0.170$) were not different between groups.

No between-group differences were noted in L-FMC outcomes (i.e., nadir diameter, absolute L-FMC, relative L-FMC) (all, $p>0.41$).

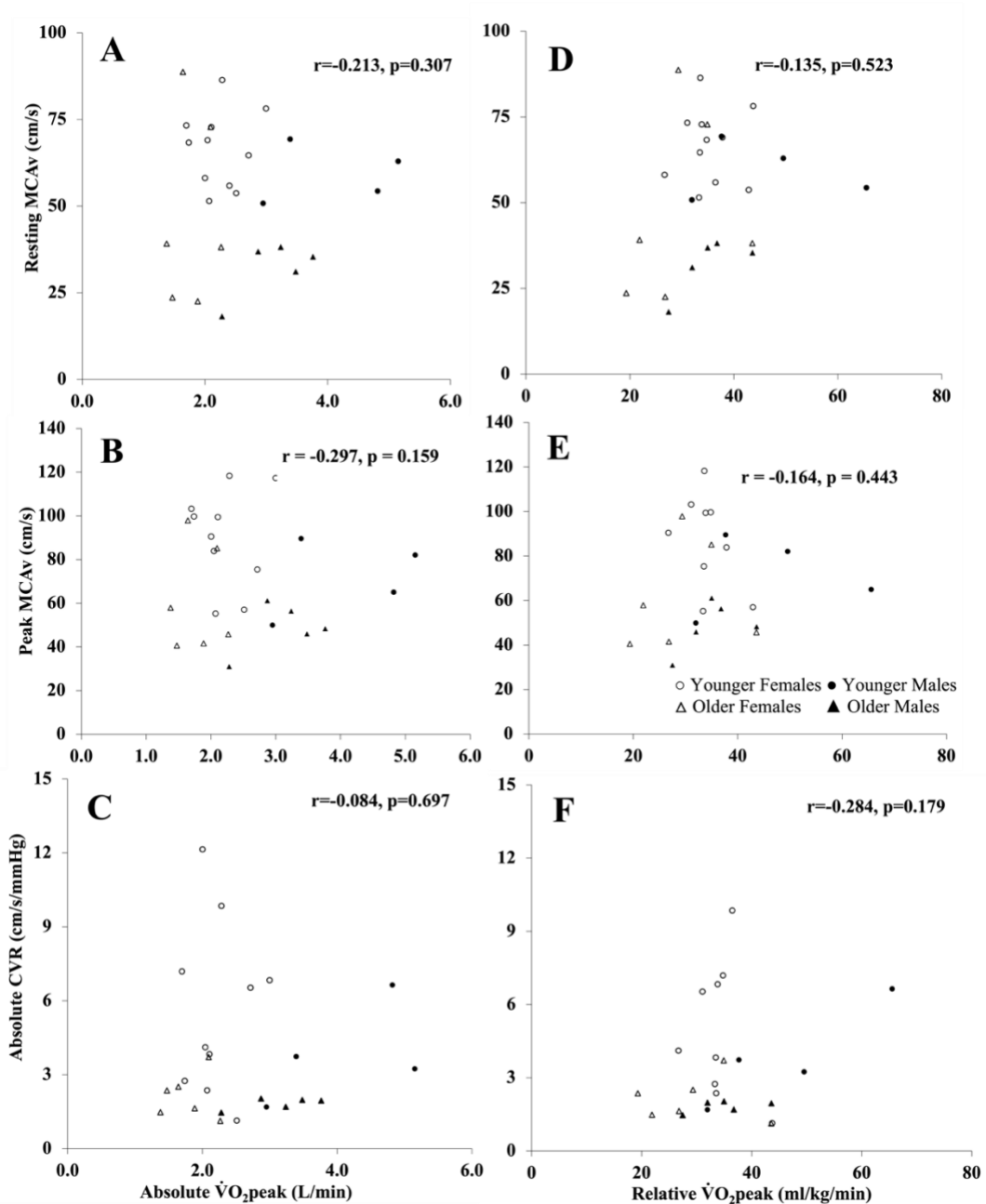

Figure 4.1. Relationships between absolute $\dot{V}O_{2peak}$ versus resting middle cerebral artery velocity (MCAv) (A), peak MCAv (B) and absolute cerebrovascular reactivity CVR (C), as well as between relative $\dot{V}O_{2peak}$ versus MCAv (D), peak MCAv (E) and absolute CVR (F) are reported separately for each sex within the younger and older adult groups. Pearson's correlations (r) were conducted on relationships using the entire cohort. All assumptions for using Pearson's correlations were met. Age was included as a covariate in all models. There were no associations when correlations were split by age group (all, $p > 0.112$).

Table 4.3. Comparison of brachial artery outcomes between age groups.

	Cohort	Younger Adults	Older Adults	p-value
Resting Brachial Hemodynamics				
Diameter (mm)	3.9 ± 0.7 (2.8-5.5)	3.9 ± 0.7 (2.9-5.3)	4.0 ± 0.8 (2.8-5.5)	0.860
RBCv (cm/s)	11.0 ± 4.9 (2.1-21.4)	11.6 ± 5.6 (2.1-21.4)	10.5 ± 4.3 (2.4-20.1)	0.956
Blood flow (mL/min)	82 ± 39 (16-188)	82 ± 33 (38-139)	82 ± 46 (16-188)	0.681
Shear rate (/s)	135 ± 59 (47-261)	142 ± 60 (47-253)	128 ± 59 (55-261)	0.425
Flow-Mediated Dilatation (FMD)				
Peak Diameter (mm)	4.2 ± 0.8 (3.0-5.9)	4.2 ± 0.7 (3.1-5.6)	4.2 ± 0.8 (3.0-5.9)	0.937
Absolute FMD (mm)	0.22 ± 0.08 (0.03-0.43)	0.24 ± 0.06 (0.10-0.32)	0.21 ± 0.10 (0.03-0.43)	0.406
Relative FMD (%)	5.8 ± 1.9 (1.0-7.9)	6.1 ± 1.7 (3.3-7.9)	5.4 ± 2.1 (1.0-7.8)	0.201
Shear Rate AUC (a.u.)	13788 ± 6820 (2207-25194)	13200 ± 8053 (2207-25194)	14465 ± 5298 (6117-22087)	0.624
Time-to-Peak Dilatation (s)	57 ± 23 (26-126)	50 ± 19 (30-85)	63 ± 25 (26-126)	0.158
Low-Flow-Mediated Constriction (L-FMC)				
Nadir Diameter (mm)	3.8 ± 0.8 (2.3-5.3)	3.9 ± 0.7 (2.8-4.9)	3.8 ± 0.9 (2.3-5.3)	0.409
Absolute L-FMC (mm)	-0.18 ± 0.26 (-1.19-0.29)	-0.16 ± 0.15 (-0.47-0.01)	-0.20 ± 0.33 (-1.19-0.29)	0.981
Relative L-FMC (%)	-0.05 ± 0.07 (-0.35-0.07)	-0.04 ± 0.03 (-0.13-0.00)	-0.06 ± 0.10 (-0.35-0.07)	0.867
Nitroglycerin-Mediated Dilatation (NMD)				
Peak Diameter (mm)	4.6 ± 0.8 (3.4-6.3)	4.4 ± 0.7 (3.5-5.6)	4.9 ± 0.9 (3.4-6.3)	0.170
Absolute NMD (mm)	0.64 ± 0.20 (0.33-1.29)	0.55 ± 0.12 (0.33-0.74)	0.73 ± 0.24 (0.42-1.29)	0.015
Relative NMD (%)	16.0 ± 5.4 (9.8-31.9)	14.0 ± 2.7 (9.8-19.1)	18.3 ± 6.9 (13.3-31.9)	0.118
Relative FMD/NMD (a.u.)	0.4 ± 0.2 (0.1-0.7)	0.5 ± 0.2 (0.2-0.7)	0.4 ± 0.1 (0.1-0.6)	0.181

Data presented as means±standard deviations. RBCv, red blood cell velocity; FMD, flow-mediated dilatation; AUC, area under the curve; L-FMC, low-flow mediated constriction; NMD, nitroglycerin-mediated dilatation. Between-group differences assessed via independent samples t-tests or Mann-Whitney U tests.

4.5 Relationships Between Aerobic Fitness & Habitual Activity versus Brachial Artery Outcomes

Relationships between aerobic fitness outcomes and brachial arterial function are presented in Figure 4.2. No relationships were observed between relative brachial FMD versus absolute or relative $\dot{V}O_2$ peak (Figure 4.2A, C) (all, $p>0.541$). Absolute brachial FMD was not related to absolute or relative $\dot{V}O_2$ peak (all, $p>0.248$). Furthermore, there were no relationships between relative brachial FMD versus the percent of age-predicted $\dot{V}O_2$ peak, ACSM fitness percentile rank, or CSEP fitness category ($p>0.358$). (Supplemental Figure 3A, C and E). Absolute FMD was not related to the percent of age-predicted $\dot{V}O_2$ peak, ACSM Percentile Rank or CSEP Fitness Categories (all, $p>0.431$). No relationships were significant when run separately in each age group (all, $p>0.09$).

Relative brachial NMD was not related to absolute or relative $\dot{V}O_2$ peak (Figure 4.2B, D) (all, $p>0.278$). Absolute NMD was also not related to either absolute or relative $\dot{V}O_2$ peak (all, $p>0.142$). However, relative NMD was positively associated with the percent of age-predicted $\dot{V}O_2$ peak ($p=0.022$) (Supplemental Figure 3B), but not with the ACSM Percentile Rank or CSEP Fitness Categories (all, $p>0.129$), Supplemental Figure 3D and F). Absolute NMD was positively related to both CSEP fitness category and ACSM percentile rank (all, $p<0.047$), but not the percent of age-predicted $\dot{V}O_2$ peak ($p=0.052$). No relationships were significant when run separately in each age group (all, $p>0.09$).

No relationships were observed between any outcome of aerobic fitness (i.e., absolute $\dot{V}O_2$ peak, relative $\dot{V}O_2$ peak, percent of age-predicted $\dot{V}O_2$ peak, ACSM Percentile rank, CSEP Fitness Categories) versus absolute or relative brachial L-FMC (all, $p>0.402$).

No outcome of habitual activity (i.e., sedentary time, LPA, MVPA) was associated with any outcome of brachial endothelial function (i.e., brachial FMD, L-FMC, NMD) (all, $p > 0.05$).

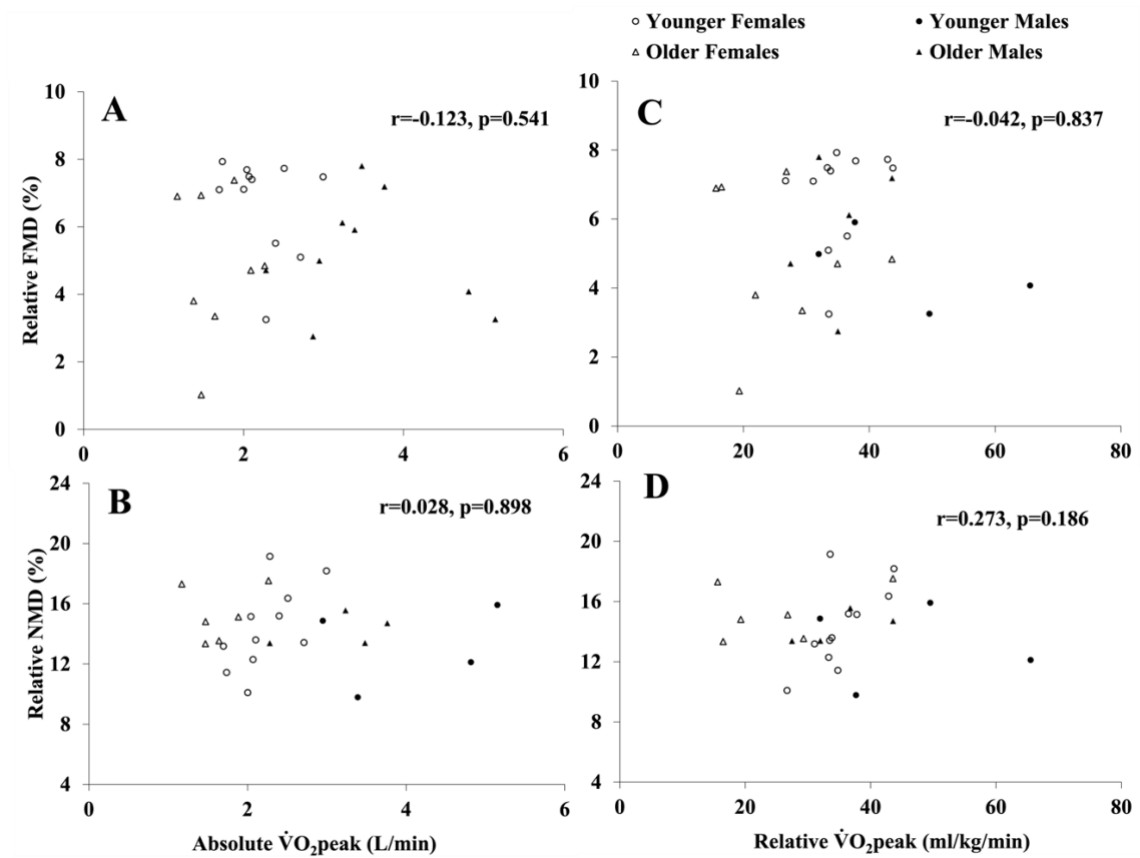

Figure 4.2. Relationship between absolute $\dot{V}O_{2peak}$ and brachial relative flow-mediated dilation (FMD) (A) and relative nitroglycerin-mediated dilation (NMD) (B), as well as relative $\dot{V}O_{2peak}$ versus brachial relative FMD (C) and relative NMD (D). Pearson correlation (r) analyses were conducted for all relationships. All assumptions for using Pearson's correlations were met. Age was included as a co-variate in all models. There were no associations when correlations were split by age group (all, $p > 0.09$).

4.6 Relationships Between Brachial Artery Outcomes Versus Cerebrovascular Regulation

There were no associations between brachial relative FMD versus resting MCAv, relative or absolute CVR (all, $p > 0.08$, Figure 4.3A-C). There were no associations between absolute FMD versus resting MCAv, relative or absolute CVR (all, $p > 0.109$). Furthermore, brachial L-FMC and NMD responses (both absolute and relative) were not related to resting MCAv, absolute or relative CVR (all, $p > 0.114$). No relationships were significant when run separately in each age group (all, $p > 0.07$).

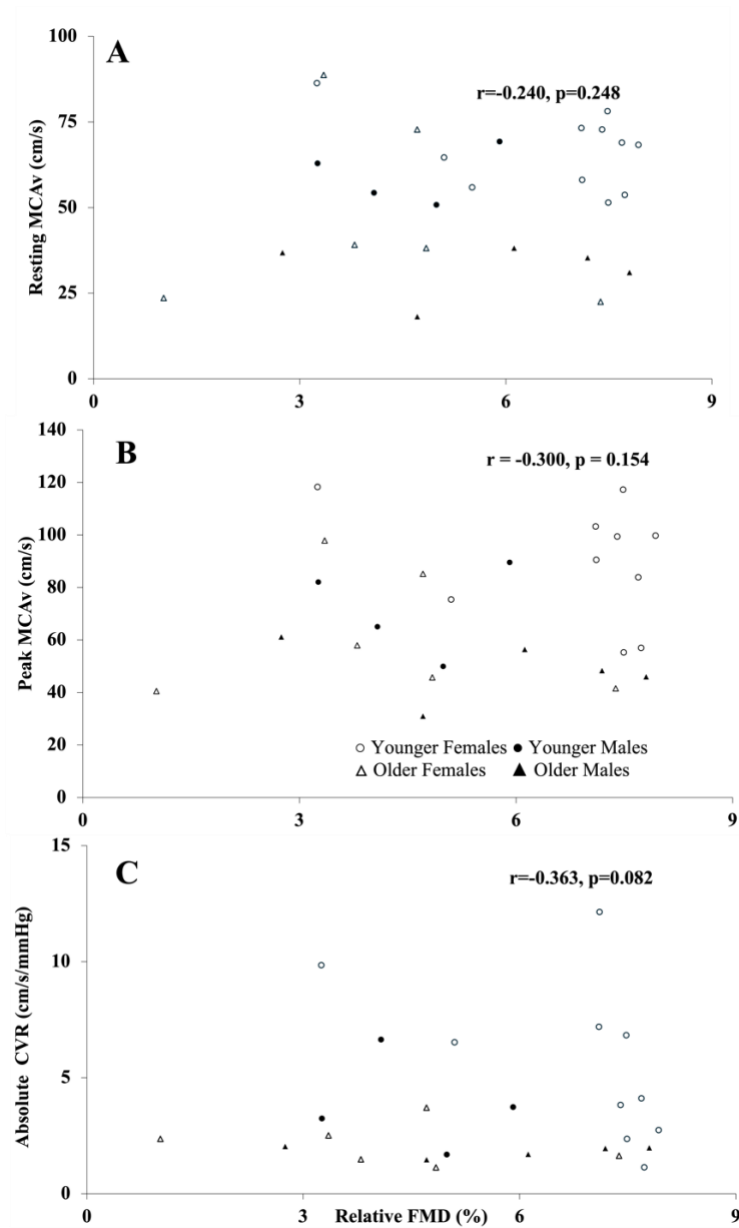

Figure 4.3. The relationship between brachial flow-mediated dilation (FMD) versus resting middle cerebral artery velocity (MCAv) (A), peak MCAv (B), and absolute cerebrovascular reactivity (CVR) (C). Pearson correlation analyses were conducted for all relationships. All assumptions for using Pearson’s correlations were met. Each model was adjusted for age as a co-variate. No significant relationships were observed (all, $p > 0.08$). There were no associations when correlations were split by age group (all, $p > 0.07$).

CHAPTER 5 – DISCUSSION

The primary objective of this study was to evaluate in healthy younger and older adults whether: 1) aerobic fitness was related to resting MCAv, CVR and/or brachial FMD, and 2) brachial FMD was associated with CVR. A secondary objective was to explore whether brachial L-FMC was associated with cerebrovascular outcomes. Based on previous literature, it was hypothesized that aerobic fitness would be positively associated with both resting MCAv (37, 38) and brachial FMD (33, 178). Given the discrepancies in the literature regarding the brachial endothelial function – cerebral endothelial function relationship (23, 179), and the aerobic fitness-CVR association (36, 42)(5, 6), it was unclear whether any significant relationships would be observed in this study. Additionally, given the known negative impact of age on brachial (10) and cerebral arterial function (180), differences in primary outcomes between age groups were also investigated. In contrast with my hypothesis, resting MCAv (Figure 4.1) and brachial-FMD (Figure 4.2) were unrelated to absolute and relative $\dot{V}O_{2peak}$. Furthermore, aerobic fitness was unrelated to CVR, and brachial FMD demonstrated no associations with MCAv or CVR. The results of this study demonstrated that neither better aerobic fitness or brachial artery function translated into elevated resting MCAv or enhanced CVR responses.

Endothelial dysfunction, or the ability of the vasculature to dilate or constrict in response to physical or chemical stimuli, plays an important role in the detection of CVD and CBVD (8, 14, 15). Specifically, endothelial function plays a key role in the regulation of vascular tone (75), and the maintenance of proper CBF (106, 114). Brachial FMD is a commonly used method to examine endothelial-dependent vasodilation (11), and has been directly related with coronary artery vasodilation (181). However, the requirement of the brain to maintain a constant blood supply makes a similar ischemia-based assessment impractical for the cerebral vasculature (121).

Therefore, CVR assessments have been used previously to provide some insight into cerebral artery endothelial-dependent function (123, 124). Furthermore, there is some evidence that brachial endothelial-dependent outcomes, including brachial FMD, are related to CVR(21, 22). Both brachial FMD (10, 137) and CVR decrease with age (26, 27). Furthermore, aerobic fitness improves both brachial endothelial-dependent (8, 151, 154) and CBF outcomes (37, 38), yet contradicting evidence remains surrounding the relationship between aerobic fitness and CVR (36, 42). Finally, although endothelial function is important for both brachial FMD and CVR, their relationship is not yet fully understood.

Carr et al. (23) investigated the relationship between brachial FMD and an index of cerebral FMD in 19 healthy young adults (23 ± 6 years, 6♀). Specifically, cerebral FMD was assessed in the ICA by recording peak vasodilatory responses to elevated CBF/shear stress, induced by a transient increase in P_{ETCO_2} (23, 182). The main findings from this study were that brachial and cerebral/ICA FMD responses were not correlated (neither were endothelial-independent responses).

5.1 Impact of Age on Aerobic Fitness

The present study observed between-group differences in relative $\dot{V}O_{2peak}$ (Table 4.1). Furthermore, between-group differences were observed in habitual activity outcomes, LPA and MVPA (Table 4.1), although no differences in sedentary time (hours/day), daily step count (steps/day) were observed (Table 4.1). The impact of age on declining aerobic fitness is well-established and has been attributed to reductions in muscle oxygen delivery associated with reduced cardiac output and skeletal muscle oxidative capacity, by way of mitochondrial dysfunction (183).

5.2 Impact of Age on Cerebrovascular Function

Age-related reductions in resting CBF are an important determining factor in the onset of CBVD (147, 150). In the present study, the older adults demonstrated a lower resting MCAv compared to the younger adults (Older Adults: 40 ± 22 cm/s versus Younger Adults: 65 ± 11 cm/sec, $p=0.003$) (Table 4.2). Additionally, younger adults demonstrated a higher absolute CVR response (5.2 ± 3.2 cm/s/mmHg) compared to the older adults (2.0 ± 0.7 cm/s/mmHg, $p=0.004$), while no differences in relative CVR were observed between groups ($p=0.075$) (Table 4.2). The results of this study align with previous literature, although a few key differences in population and resting measures exist. Specifically, as previously described, Ainslie et al. (37) assessed the relationship between aerobic fitness status and resting MCAv in a group of healthy males ($n=307$, 18-79 years) (37). The results of this study demonstrated an age-related decline in resting MCAv, regardless of training status, outlining that ageing attenuates resting MCAv (37). While the exact mechanisms of this age-related decline remain unknown due to the location of the cerebral vessels, it has been attributed to impaired regulation of vascular tone and endothelial-dependent vasodilatory functions, in part due to cerebral arterial stiffening (24, 26, 27, 138).

Thomas et al. (36) compared CVR responses between younger adults ($n=9$, 27 ± 4 years, 4♀, no $\dot{V}O_2$ peak data assessed), Masters athletes ($n=10$, 75 ± 6 years, 3♀, 40.6 ± 2.0 ml/kg/min) and inactive older adults ($n=10$, 75 ± 6 years, 2♀, 23.4 ± 1.7 ml/kg/min). They determined that CVR was greater in the younger adults compared to both the Masters athletes and inactive older adults, outlining similar age-related attenuation in CVR responses demonstrated in the present study (Figure 4.1) (36). Furthermore, Klein et al. (26) compared TCD-derived resting MCAv and CVR outcomes (via repeated breath holds) between younger ($n=20$, 24 ± 4 years, 9♀) and older

adults (n=20, 71±7 years, 11♀). Similar to the present study, (9) they demonstrated that younger adults had higher resting MCAv and CVR responses (26). However, (9) they observed age-related declines in both absolute and relative CVR responses (26), while the present only observed an attenuated absolute CVR response in older adults. Differences in the results between the work by Klein et al. (26) and this study may be explained by baseline P_{ET}CO₂ values. Specifically, Klein et al. (26) noted that younger adults had a higher baseline P_{ET}CO₂ compared to older adults, while the present study observed no between-group differences. Furthermore, peak P_{ET}CO₂ values were not different in this study, but they were between groups in the study by Klein et al. (26). Finally, both this study and Klein et al. (26) demonstrated a higher baseline MCAv and peak MCAv in younger adults compared to older adults. The results from this study and Klein et al. (26) demonstrate that the difference in absolute CVR may be due to overall higher MCAv outcomes in younger adults compared to older adults. This same between group difference was not observed in relative CVR, demonstrating that baseline MCAv may not be a contributing factor in CVR responses. Although the requirements for being a Masters athlete were not assessed in the participants of the present study, the older adults in the present study were of a higher aerobic fitness relative to their age (percent of age-predicted $\dot{V}O_{2\text{peak}}$: 142 ± 51%) (Table 4.1) and are comparable to the participants in the study by Thomas et al. (36). The result of this study indicates that an impact of age-related differences is observed in terms of cerebrovascular regulation and may be unrelated to resting CBF outcomes. Given the positive association between resting P_{ET}CO₂ and relative $\dot{V}O_{2\text{peak}}$ demonstrated in this study, it could be hypothesized that increased resting P_{ET}CO₂ due to higher aerobic fitness may explain the lack of difference in relative CVR outcomes between age groups.

5.3 Impact of Aerobic Fitness on Cerebrovascular Function

As previously mentioned, absolute and relative $\dot{V}O_{2peak}$ were not associated with MCAv or CVR (Figure 4.1). This was similar if aerobic fitness was quantified as ACSM percentiles or CSEP Health Benefit Ratings (i.e., aerobic fitness classifications)(184). However, inverse relationships were observed versus both MCAv and absolute CVR when aerobic fitness was quantified as a percentage of age-predicted $\dot{V}O_{2peak}$, (Supplemental Figure 2). Finally, no outcomes of habitual physical or sedentary activity were associated with MCAv or CVR (all, $p>0.125$). No outcomes of habitual activity or sedentary patterns were related to resting MCAv, CVR, or brachial-FMD. To date, this is the first known study that investigated the relationship of habitual activity outcomes with outcomes of cerebrovascular regulation.

Although the gold standard for the quantification of aerobic fitness is $\dot{V}O_{2max/peak}$, previous research in the area has quantified aerobic fitness using less accurate methods (e.g., HR-based estimations or submaximal testing), but have demonstrated conflicting evidence as to the relationship between aerobic fitness versus peripheral and/or cerebrovascular outcomes (38, 45). Additional indices of aerobic fitness, such as comparing levels relative to age (percent of age-predicted $\dot{V}O_{2peak}$) or normative ranks/percentiles (i.e., ACSM, CSEP guidelines) may provide further insight into the aerobic fitness descriptives of participants (184).

Confounding findings exist concerning the impact of aerobic fitness on resting MCAv and CVR. Engaging in aerobic exercise and maintaining a high level of aerobic fitness with aging attenuates age-related declines in cerebral vascular function (37, 38). Specifically, Ainslie et al. (37) assessed the relationship between aerobic fitness status and resting MCAv in a group of healthy males ($n=307$, 18-79 years) (37). Participants were grouped into either self-reported untrained (i.e., did not engage in regular aerobic exercise for a minimum of 2 years), or

endurance exercise-trained (i.e., vigorous endurance exercise more than 4 times per week, and competing in local running/cycling races). They performed a multiple regression analysis and outlined that the untrained group (34.9 ± 0.4 ml/kg/min) had a consistently lower resting MCAv than the endurance-trained group (52.4 ± 0.4 ml/kg/min) across the lifespan (37). Furthermore, they observed that $\dot{V}O_{2\text{peak}}$, as assessed by either treadmill or cycle ergometer, was a significant predictor of resting MCAv (37). However, the results of Ainslie et al. (37) were only collected in males, while the present study had a predominantly female sample ($n=20/29$). Females have previously been demonstrated to exhibit increased MCAv responses compared to males, and this difference was more pronounced in younger adults, indicating a potential hormonal effect on MCAv responses (185). Specifically, the loss of estrogen associated with aging among females has been shown to worsen endothelial vasodilation (186, 187). Given the known beneficial impact of aerobic fitness on endothelial vasodilatory responses (8, 151), it could be that the relatively higher aerobic fitness levels (for their age) of the pre-dominantly female older adult group in this study (i.e., $142 \pm 51\%$ of age-predicted $\dot{V}O_{2\text{peak}}$) may have blunted the estrogen-related decline in endothelial vasodilatory function, resulting in elevated MCAv responses that did not differ from the younger adults (Table 4.1).

Furthermore, Zimmerman et al. (38) examined the relationship between estimated cardiorespiratory fitness and resting CBF (MRI-based arterial spin labelling) in 55 healthy older adults (55-85 years). They found that estimated aerobic fitness was strongly, positively correlated with CBF, as well as mediated the age-related declines in CBF (38). This manner of quantifying aerobic fitness differed from both the work of Ainslie et al. (1) and the present study, as cardiorespiratory fitness was not directly assessed, but rather determined from a validated equation, considering sex, age, body mass index, resting heart rate, and a self-reported activity

score (188). Similar to the present study (Figure 4.1), Zimmerman et al. (38) provides an example of how the method used for the quantification of aerobic fitness may alter the observed relationship with a given health outcome. Additionally, as shown by the present study, both younger and older adults achieved a higher $\dot{V}O_{2peak}$ compared to their age-predicted $\dot{V}O_{2peak}$ (Table 4.1). The present study observed a positive correlation between age-predicted $\dot{V}O_{2peak}$ and MCAv ($\rho=0.528$, $p=0.006$) (Supplemental Figure 2), similar to the results of Zimmerman et al. (38). Given that the present study demonstrated a direct relationship between age-predicted $\dot{V}O_{2peak}$, but not versus absolute/relative $\dot{V}O_{2peak}$, and that the cohort had an average percent of age-predicted $\dot{V}O_{2peak}$ of over 100% ($126\pm 44\%$), this relationship may not be indicative of a ‘normal’ population, and this observed relationship may only exist among those of a higher aerobic fitness relative to their age.

Similar to the present results (Figure 4.1), Barnes et al. (42) observed no relationship between relative $\dot{V}O_{2peak}$ and TCD-derived CVR using a stepped hypercapnia protocol in 16 healthy younger (18-34 years, 8♀, 38 ± 3 ml/kg/min) and 13 older adults (55-77 years, 6♀, 27 ± 2 ml/kg/min). The results from this study indicated no relationship between relative $\dot{V}O_{2peak}$ and CVR using outcomes from the whole cohort (42). However, when split by age group, a positive relationship between $\dot{V}O_{2peak}$ and absolute CVR was observed among the older adults only (42). Furthermore, Barnes et al. (42) looked at the change in CVR responses following the administration of a cyclooxygenase inhibitor, which demonstrated that following the inhibition prostaglandin production, older adults with the highest aerobic fitness exhibited the largest reduction in CVR. Further, this reduction in CVR was positively associated with aerobic fitness (42). Similar to the present results, Thomas et al. (36) looked at the impact of life-long aerobic exercise on CVR, as assessed by MRI, during an inhaled hypercapnia protocol (36). The

participants were grouped into Masters athletes (n=10, 75±6 years, 3♀, 40.6 ± 2.0 ml/kg/min) and inactive older adults (n=10, 75±6 years, 2♀, 23.4±1.7 ml/kg/min) (36). Masters athletes were classified as older adults who participated in regular competitions in aerobic exercise (i.e., running, cycling, swimming) for 23±8 years, with a weekly running mileage of 32±10 miles (36). Thomas et al. (36) demonstrated that the Masters athletes had a lower CVR compared to the inactive older adults, as well as an inverse relationship between relative $\dot{V}O_{2peak}$ and CVR in the whole cohort of inactive older adults and Masters athletes. It was hypothesized that this relationship may be, in part, due to a potential vascular desensitization to CO₂ among older adults who participated in continuous aerobic exercise throughout the lifespan, given the increased arterial CO₂ that is associated with aerobic exercise (36). This may explain the observed inverse relationship in the present study between absolute CVR and the percent of age-predicted $\dot{V}O_{2peak}$, given the high levels of aerobic fitness among our older adults. Overall, aerobic fitness was not related to MCAv or CVR but could be explained by the underlying mechanisms of prostaglandin production and estrogen levels on cerebral vasculature among older adults, and the contribution of potential CO₂ desensitization among those with higher levels of aerobic fitness.

5.4 Impact of Age on Brachial Endothelial Function

The results of this study did not align with results from previous literature (13, 137, 143), as various structural and functional changes to the vasculature that occur with aging have been demonstrated to result in reduced brachial endothelial-dependent (FMD) (13, 137) and endothelial-independent (NMD) (13, 143) responses. This may be explained, in part, to the higher-than-expected level of aerobic fitness among the older adults in this study, relative to their age. Previous literature has shown that older adults exhibit a decrease in elastin combined with

increased collagen in all layers of the artery, which leads to arterial stiffening, and reduced vasodilatory responses (138). Furthermore, reduced NO-bioavailability and reduced vascular smooth muscle cell sensitivity to NO is commonly observed in older adults (10). However, the present study was unable to replicate these well-established age group differences. Specifically, while no between-group difference was observed in brachial FMD responses, older adults demonstrated a higher brachial NMD response compared to younger adults.

Given the high level of aerobic fitness relative to age among the older adults of this study, in combination with the previously outlined impacts of aerobic fitness on brachial FMD outcomes (151, 189), the lack of difference between age groups can be attributed to this increased aerobic fitness among older adults. However, the opposite relationship in NMD outcomes as expected (i.e., older adults have increased absolute NMD compared to younger adults), was observed. While it has previously been established that an age-related decline in vascular smooth muscle cell sensitivity to NO exists, the mechanisms behind this attenuation remain unclear. Evidence from animal models suggest that ageing is related with a decline in the concentration of soluble guanylyl cyclase (144, 145), which decreases cGMP production and reduces vascular smooth muscle cell relaxation (Figure 2.7) (144, 145). It has been demonstrated that aerobic exercise has been effective in increasing the cGMP levels among older females (190). Given the high levels of aerobic fitness in the sample of the present study among older adults, a potential impact of increased aerobic fitness may serve as a mediator in increasing cGMP levels, and in turn, vascular smooth muscle cell sensitivity to NO.

5.5 Impact of Aerobic Fitness on Brachial Endothelial Function

Higher levels of aerobic fitness have been associated with superior brachial FMD (16, 17) and L-FMC (17) responses among both younger (154) and older adults (151, 153). The results of

this study did not observe relationships between any outcome of aerobic fitness and brachial FMD (Figure 4.2) or L-FMC. Absolute and relative NMD were both positively associated with the percent of age-predicted $\dot{V}O_{2peak}$ (Supplemental Figure 3), but neither was associated with absolute or relative $\dot{V}O_2$ (Figure 4.2). Absolute NMD was positively related to both CSEP fitness category and ACSM percentile rank (Supplemental Figure 3). Relative NMD was not associated with either CSEP fitness category or ACSM percentile rank (Supplemental Figure 3). Outcomes of habitual activity (i.e., sedentary time, LPA, MVPA) were not related to any outcome of brachial arterial function.

Given the known impact of age and aerobic fitness on brachial endothelial outcomes, it may be possible that the high level of aerobic fitness among the older adults in this study may blunt the age-related decline in brachial endothelial-dependent and independent responses. This effect was shown by Black et al. (142), who examined the age-related attenuation in brachial-FMD and the blunting of this age-related attenuation in 18 young, healthy adults (26 ± 1 years, 9♀, Males: 56 ± 2 ml/kg/min, Females: 42 ± 3 ml/kg/min), 12 older aerobically-trained adults (57 ± 2 years, 9♀, Males: 52 ± 4 ml/kg/min, Females: 42 ± 2 ml/kg/min) and 16 older inactive adults (60 ± 2 years, 8♀, Males: 32 ± 2 ml/kg/min, Females: 24 ± 1 ml/kg/min). The results of this study (142) demonstrated that older, inactive adults had a lower brachial FMD response compared to both older aerobically trained adults and younger adults, demonstrating the age-related decline in brachial FMD that was then attenuated by increased cardiopulmonary fitness (142). This effect was also observed in the present study, and is concordant with the literature, given the well-established relationship between aerobic fitness has been associated with higher FMD responses (151, 154) due to the increase in the bioavailability of NO associated with increased aerobic fitness (152).

The results of this study are discordant with those of Bell et al. (45) who demonstrated that estimated $\dot{V}O_{2peak}$, as assessed by a submaximal cycle ergometry test was associated with better brachial L-FMC responses in a group of younger males ($n=20$, 23 ± 5 years) (45), as well as those by O'Brien et al. (153) that reported an inverse relationship between brachial L-FMC and relative $\dot{V}O_{2peak}$ in healthy older adults (i.e., higher aerobic fitness associated with better brachial L-FMC responses). Given the sample of younger males in the study by Bell et al. (45) compared to the female dominant sample in the present study ($n=20/29$), discrepancies exist in the population of each study. Although the sex differences in brachial L-FMC responses are understudied, the results of the present study compared with those of Bell et al. (45) may identify a potential impact of sex on brachial L-FMC, and may be concordant with the previous given hypothesis, in which the age-related declines in estrogen among older females contribute to reductions in endothelial dysfunction, and reduced vasodilatory responses (186, 187). Furthermore, O'Brien et al. (153) previously addressed the relationship between $\dot{V}O_{2peak}$ and brachial L-FMC responses in a group of less aerobically fit ($n=27$, 68 ± 8 years, 19♀ , 18.3 ± 3.2 ml/kg/min) and more aerobically fit ($n=20$, 66 ± 4 , 11♀ , 29.1 ± 5.8) older adults. They (35) demonstrated a negative correlation between $\dot{V}O_{2peak}$ and L-FMC responses in the pooled sample (153), which was not observed in this study. However, the $\dot{V}O_{2peak}$ of the cohort in the study by O'Brien et al. (153) was lower than the present study (22.9 ± 7.0 ml/kg/min vs 34.1 ± 10.2 ml/kg/min). Although understudied, it could be hypothesized that the relationship between $\dot{V}O_{2peak}$ and L-FMC may not be linear throughout all ranges of aerobic fitness outcomes. However, EDHFs have been shown to mediate brachial L-FMC responses in a younger population (44). Although understudied in older adults, research using rat models has outlined that EDHF bioavailability was decreased in older rats compared to younger but was restored

following an aerobic exercise intervention (191). This observed restoration effect of aerobic fitness on EDHF bioavailability may contribute to the similar L-FMC responses between younger and older adults in the present study.

While the underlying mechanistic effects of aerobic fitness on L-FMC responses remain relatively understudied, aerobic training studies (i.e., 3 months aerobic exercise 5+ days/week) have demonstrated reductions in plasma concentration of ET-1 among older females (192), as well as improved $\dot{V}O_{2\text{peak}}$ and larger ET-1 vasoconstrictor response among older males (193). Aerobic fitness has been shown to upregulate both antioxidant systems and eNOS expression, while lowering levels of ET-1 (63, 175). Given these effects of aerobic training on ET-1, it may be hypothesized that the lack of relationship between L-FMC and $\dot{V}O_{2\text{peak}}$ in the present study may be attributed to higher aerobic fitness among older adults. Given that shear stress is a stimulatory mechanism of ET-1 production, and no between-group differences were observed in L-FMC responses, older adults who are more aerobically fit may likely have increased endothelium sensitivity to reductions in shear stress, allowing for similar L-FMC responses compared to younger adults. Finally, given that there was no observed relationship between aerobic fitness and FMD responses, it could also be reasoned that there is no relationship between aerobic fitness and ET_A responses, given that those with higher aerobic fitness did not have a greater NO bioavailability, and no increased NO-mediated inhibition of endothelin-1.

Furthermore, a study by Johns et al. (194) looked at the impact of habitual activity outcomes (i.e., sedentary time, LPA, MVPA) on brachial-endothelial dependent outcomes in a group of young healthy adults ($n=26$, 23 ± 3 years, 13♀ , 42.4 ± 6.6 ml/kg/min) and demonstrated that no outcome of habitual activity was related to brachial FMD responses, similar to the present study. However, O'Brien et al. (155) demonstrated that in a group of healthy older adults ($n=21$,

67±7 years, 14♀, 23.9±8.3 ml/kg/min), those who met the MVPA guidelines of ~150 minutes/week had an improved relative FMD response compared to those who did not. More specifically, Johns et al. (194) observed this relationship in a group of younger adults, while O'Brien et al. (155) looked at this relationship among older adults.(40) Given the inclusion of older adults in the present study and their level of aerobic fitness compared to the older adults in the study by O'Brien et al. (155), the relationship between MVPA and brachial-FMD responses may be different among varying levels of aerobic fitness. In general, outcomes of aerobic fitness and habitual activity were not related to brachial endothelial-dependent function.

5.6 Impact of Brachial Artery Function on Cerebrovascular Function

There were no relationships observed between brachial FMD, L-FMC or NMD with either CVR outcome (Figure 4.3). The risk of both CBVD and CVD is partially due to the age-related structural and functional changes to the vasculature, which include the NO endothelial-dependent mechanisms in both the cerebral (21, 27) and peripheral vasculature (13, 137). Given the shear-stress activation of eNOS pathways associated with both peripheral and cerebral endothelial function, it begs the question if peripheral endothelial-dependent mechanisms are related to the endothelial-dependent regulatory functions of the cerebral vasculature (23, 195). However, the relationship between both of these endothelial-dependent mechanisms remains understudied. As an assessment of endothelial-independent dilation, Carr et al. (23) also administered a sublingual dose of glyceryl trinitrate and assessed the subsequent dilation effect in both the ICA and brachial artery via duplex ultrasonography. Using a linear mixed model analysis, Carr et al. (23) determined that endothelial-dependent and independent responses were not related between ICA and brachial arteries. However, differences have been identified that the pathogenesis of atherosclerosis may differ between the MCA and ICA, indicating that endothelial

function assessed in the internal carotid may not necessarily be indicative of endothelial function of the cerebral vessels (196).

In disagreement with the present study, Akazawa et al. (179) assessed the relationship between micro-vascular endothelial function, as assessed by reactive hyperemia in the index finger and resting MCAv outcomes in a group of middle-aged to older males (n=60, 62±9 years). This group observed a positive relationship between micro-vascular endothelial function and resting MCAv (179). The results from the present study disagree with the results shown by Akazawa et al. (179), but could be explained by both outcomes of peripheral endothelial function, and sex differences. Specifically, the present study assessed macrovascular endothelial function by way of brachial FMD, while Akazawa et al. (179) assessed microvascular endothelial function via finger plethysmography and reactive hyperemia. A study by Babcock et al. (197) compared these two methods (i.e., microvasculature via reactive hyperemia vs macrovascular via brachial-FMD) in a group of younger (n=20, 18-40 years) and older males (n=20, 60-75 years). Linear regression analysis demonstrated that brachial FMD responses decreased with age, while microvascular reactive hyperemia responses increased with age, potentially to compensate for the lower FMD response (197). The results shown by Babcock et al. (197) demonstrated that endothelial-dependent vasodilation responses in the microvascular and microvasculature may provide different information and cannot necessarily be compared to one another. In general, the results of the present study demonstrate that peripheral endothelial function is unrelated to endothelial-dependent mechanisms in the cerebral vasculature.

5.7 Strengths & Limitations

This study adds novelty to the literature as the first study to look at the relationship between cerebral vascular reactivity and brachial FMD outcomes in a sample of both younger

and older adults. As well, this was the first study to look at the relationship between habitual activity and sedentary patterns on outcomes of cerebrovascular regulation. Furthermore, the gold standard of assessing aerobic fitness (i.e., indirect calorimetry) was used in the present study, and provides strength to the methodology.

However, the present study is limited in the cross-sectional design. An interventional design would have allowed for the direct assessment of exercise training on the impact of cerebrovascular function. This project is limited in terms of methodology, as the utilization of MCAv is an indirect measurement of CBF. Non-imaging TCD units are unable to assess the lumen diameter of the insonated vessel and rely on the assumption that changes in RBCv reflect CBF independent of corresponding alterations in lumen diameter. However, there is evidence to suggest that this may not be as extensive a limitation as previously believed (198) Furthermore, the use of TCD to assess MCAv is an outcome of oxygen delivery outcomes, and not the utilization or extraction of oxygen.

As well, brachial FMD may not be an accurate reflection of global endothelial function. A limitation of the present study was that we were not able to assess the impact of aerobic fitness on cerebral FMD, which may provide a more direct outcome of cerebral endothelial function. Further, the high level of aerobic fitness among the population may not be indicative of “normal” aging and does not provide a true representation of the population. A wider range of absolute and relative $\dot{V}O_{2\text{peak}}$ would provide a better insight into this relationship across a wide range of participants.

5.8 Conclusions

Future research should look into the specific underlying mechanisms involved with cerebral vascular function, as this relates to healthy ageing, as well as the underlying

mechanisms involved with vascular functions, such as L-FMC and NMD, and how they may relate to the potential endothelial-dependent mechanisms involved with cerebral vascular function. Furthermore, investigating the impact of aerobic fitness on a direct outcome of cerebral endothelial function, cerebral FMD, may provide further insight into the true impact of aerobic fitness on cerebral vascular endothelial function. Finally, given the cross-sectional design of the present study, an aerobic exercise intervention could be implemented to view a more impactful effect of aerobic fitness on cerebrovascular functions.

In conclusion, no relationship between aerobic fitness and peripheral or cerebral vascular function was observed. Furthermore, our outcome of peripheral endothelial function was unrelated to cerebral vascular function. This may have been attributed to the high level of aerobic fitness among older adults, and the known impact of increased aerobic fitness on vascular functions, such as L-FMC and NMD, and how they may relate to the potential mechanisms involved with cerebral vascular function.

REFERENCES

1. **Statistics Canada.** Population projections for Canada (2021 to 2068), provinces and territories (2021 to 2043). [Online]. *StatCanada*: 2022. <https://www150.statcan.gc.ca/n1/pub/91-520-x/91-520-x2022001-eng.htm>.
2. **Lakatta MEG.** Age-associated cardiovascular changes in health: impact on cardiovascular disease in older persons. *Heart Fail Rev* 7: 29–49, 2002. doi: 10.1023/A:1013797722156.
3. **Public Health Agency of Canada.** Canadian chronic disease surveillance system. [Online]. *Government of Canada*: 2021. <https://health-infobase.canada.ca/ccdss/data-tool/>.
4. **Capildeo R, HS, CRF.** The definition and classification of stroke. A new approach. *Q J Med* 47: 177–196, 1978. doi: 10.1093/oxfordjournals.qjmed.a067535.
5. **Portegies MLP, Koudstaal PJ, Ikram MA.** Cerebrovascular disease. In: *H Clin Neuro*. 2016, p. 239–261.
6. **StatCanada.** Leading causes of death, total population, by age group. [Online]. 2022. <https://www150.statcan.gc.ca/t1/tbl1/en/tv.action?pid=1310039401>.
7. **Choudhury MJH, Chowdhury MTI, Nayeem A, Jahan WA.** Modifiable and non-modifiable risk factors of stroke: A review update. *J Nat Inst Neuro Bangl* 1: 22–26, 2015. doi: 10.3329/jninb.v1i1.22944.
8. **Inaba Y, Chen JA, Bergmann SR.** Prediction of future cardiovascular outcomes by flow-mediated vasodilatation of brachial artery: a meta-analysis. *Int J Cardiovasc Imaging* 26: 631–640, 2010. doi: 10.1007/s10554-010-9616-1.

9. **Toda N.** Age-related changes in endothelial function and blood flow regulation. *Pharmacol Ther* 133: 159–176, 2012. doi: 10.1016/j.pharmthera.2011.10.004.
10. **Seals DR, Jablonski KL, Donato AJ.** Aging and vascular endothelial function in humans. *Clin Sci* 120: 357–375, 2011. doi: 10.1042/CS20100476.
11. **Thijssen DHJ, Black MA, Pyke KE, Padilla J, Atkinson G, Harris RA, Parker B, Widlansky ME, Tschakovsky ME, Green DJ.** Assessment of flow-mediated dilation in humans: a methodological and physiological guideline. *Amer J Physiol-Heart Circul Physiol* 300: H2–H12, 2011. doi: 10.1152/ajpheart.00471.2010.
12. **Ras RT, Streppel MT, Draijer R, Zock PL.** Flow-mediated dilation and cardiovascular risk prediction: a systematic review with meta-analysis. *Int J Cardiol* 168: 344–351, 2013. doi: 10.1016/J.IJCARD.2012.09.047.
13. **Parker BA, Ridout SJ, Proctor DN.** Age and flow-mediated dilation: a comparison of dilatory responsiveness in the brachial and popliteal arteries. *Amer J Physiol-Heart Circul Physiol* 291: H3043–H3049, 2006. doi: 10.1152/ajpheart.00190.2006.
14. **Biose IJ, Oremosu J, Bhatnagar S, Bix GJ.** Promising cerebral blood flow enhancers in acute ischemic stroke. *Transl Stroke* 14: 863–889, 2023. doi: 10.1007/s12975-022-01100-w.
15. **Aaslid R.** Cerebral autoregulation and vasomotor reactivity. In: *H Neuro Ultra*. Basel: KARGER, 2006, p. 216–228.
16. **Bishop CC, Powell S, Rutt D, Browse NL.** Transcranial Doppler measurement of middle cerebral artery blood flow velocity: a validation study. *Stroke* 17: 913–915, 1986. doi: 10.1161/01.STR.17.5.913.

17. **Fierstra J, Sobczyk O, Battisti-Charbonney A, Mandell DM, Poublanc J, Crawley AP, Mikulis DJ, Duffin J, Fisher JA.** Measuring cerebrovascular reactivity: what stimulus to use? *J Physiol* 591: 5809–5821, 2013. doi: 10.1113/jphysiol.2013.259150.
18. **Tancredi FB, Hoge RD.** Comparison of cerebral vascular reactivity measures obtained using breath-holding and CO₂ inhalation. *J Cere Blood Metabol* 33: 1066–1074, 2013. doi: 10.1038/jcbfm.2013.48.
19. **Silverman A, PNH.** Physiology, cerebral autoregulation [Online]. *StatPearls Publishing*: 2023. <https://www.ncbi.nlm.nih.gov/books/NBK553183/>.
20. **Pretnar-Oblak J.** Cerebral endothelial function determined by cerebrovascular reactivity to l-arginine. *Biomed Res Int* 2014: 1–8, 2014. doi: 10.1155/2014/601515.
21. **Lavi S, Gaitini D, Milloul V, Jacob G.** Impaired cerebral CO₂ vasoreactivity: association with endothelial dysfunction. *Amer J Physiol-Heart Circul Physiol* 291: H1856–H1861, 2006. doi: 10.1152/ajpheart.00014.2006.
22. **Ainslie PN, Murrell C, Peebles K, Swart M, Skinner MA, Williams MJA, Taylor RD.** Early morning impairment in cerebral autoregulation and cerebrovascular CO₂ reactivity in healthy humans: relation to endothelial function. *Exp Physiol* 92: 769–777, 2007. doi: 10.1113/expphysiol.2006.036814.
23. **Carr JMJR, Hoiland RL, Caldwell HG, Coombs GB, Howe CA, Tremblay JC, Green DJ, Ainslie PN.** Internal carotid and brachial artery shear-dependent vasodilator function in young healthy humans. *J Physiol* 598: 5333–5350, 2020. doi: 10.1113/JP280369.
24. **Izzo C, Carrizzo A, Alfano A, Virtuoso N, Capunzo M, Calabrese M, De Simone E, Sciarretta S, Frati G, Oliveti M, Damato A, Ambrosio M, De Caro**

- F, Remondelli P, Vecchione C.** The impact of aging on cardio and cerebrovascular diseases. *Int J Mol Sci* 19: 481, 2018. doi: 10.3390/ijms19020481.
25. **Ashby JW, Mack JJ.** Endothelial control of cerebral blood flow. *Am J Pathol* 191: 1906–1916, 2021. doi: 10.1016/j.ajpath.2021.02.023.
26. **Klein T, Bailey TG, Wollseiffen P, Schneider S, Askew CD.** The effect of age on cerebral blood flow responses during repeated and sustained stand to sit transitions. *Physiol Rep* 8, 2020. doi: 10.14814/phy2.14421.
27. **Bakker SLM, de Leeuw F-E, den Heijer T, Koudstaal PJ, Hofman A, Breteler MMB.** Cerebral haemodynamics in the elderly: The rotterdam study. *Neuroepidemiol* 23: 178–184, 2004. doi: 10.1159/000078503.
28. **Wahid A, Manek N, Nichols M, Kelly P, Foster C, Webster P, Kaur A, Friedemann Smith C, Wilkins E, Rayner M, Roberts N, Scarborough P.** Quantifying the association between physical activity and cardiovascular disease and diabetes: A systematic review and meta-analysis. *J Am Heart Assoc* 5, 2016. doi: 10.1161/JAHA.115.002495.
29. **Murray KO, Mahoney SA, Venkatasubramanian R, Seals DR, Clayton ZS.** Aging, aerobic exercise, and cardiovascular health: Barriers, alternative strategies and future directions. *Exp Gerontol* 173: 112105, 2023. doi: 10.1016/j.exger.2023.112105.
30. **Gallanagh S, Quinn TJ, Alexander J, Walters MR.** Physical activity in the prevention and treatment of stroke. *ISRN Neurol* 2011: 1–10, 2011. doi: 10.5402/2011/953818.
31. **Sahathevan R, Brodtmann A, Donnan GA.** Dementia, stroke, and vascular risk factors; a review. *Inter J Stroke* 7: 61–73, 2012. doi: 10.1111/j.1747-4949.2011.00731.x.

32. **Shannon OM, Clifford T, Seals DR, Craighead DH, Rossman MJ.** Nitric oxide, aging and aerobic exercise: Sedentary individuals to Master's athletes. *Nitric Oxide* 125–126: 31–39, 2022. doi: 10.1016/j.niox.2022.06.002.
33. **Seals DR.** Edward F. Adolph Distinguished Lecture: The remarkable anti-aging effects of aerobic exercise on systemic arteries. *J Appl Physiol* 117: 425–439, 2014. doi: 10.1152/jappphysiol.00362.2014.
34. **Ashor AW, Lara J, Siervo M, Celis-Morales C, Oggioni C, Jakovljevic DG, Mathers JC.** Exercise modalities and endothelial function: A systematic review and dose–response meta-analysis of randomized controlled trials. *Sports Med* 45: 279–296, 2015. doi: 10.1007/s40279-014-0272-9.
35. **Tao X, Chen Y, Zhen K, Ren S, Lv Y, Yu L.** Effect of continuous aerobic exercise on endothelial function: A systematic review and meta-analysis of randomized controlled trials. *Front Physiol* 14, 2023. doi: 10.3389/fphys.2023.1043108.
36. **Thomas BP, Yezhuvath US, Tseng BY, Liu P, Levine BD, Zhang R, Lu H.** Life-long aerobic exercise preserved baseline cerebral blood flow but reduced vascular reactivity to CO₂. *J Mag Imag* 38: 1177–1183, 2013. doi: 10.1002/jmri.24090.
37. **Ainslie PN, Cotter JD, George KP, Lucas S, Murrell C, Shave R, Thomas KN, Williams MJA, Atkinson G.** Elevation in cerebral blood flow velocity with aerobic fitness throughout healthy human ageing. *J Physiol* 586: 4005–4010, 2008. doi: 10.1113/jphysiol.2008.158279.
38. **Zimmerman B, Sutton BP, Low KA, Fletcher MA, Tan CH, Schneider-Garces N, Li Y, Ouyang C, Maclin EL, Gratton G, Fabiani M.** Cardiorespiratory fitness mediates the effects of aging on cerebral blood flow. *Front Aging Neurosci* 7: 59, 2014. doi: 10.3389/fnagi.2014.00059.

39. **Smith EC, Pizzey FK, Askew CD, Mielke GI, Ainslie PN, Coombes JS, Bailey TG.** Effects of cardiorespiratory fitness and exercise training on cerebrovascular blood flow and reactivity: A systematic review with meta-analyses. *Amer J Physiol-Heart Circul Physiol* 321: H59–H76, 2021. doi: 10.1152/ajpheart.00880.2020.
40. **Foster C, Steventon JJ, Helme D, Tomassini V, Wise RG.** Assessment of the effects of aerobic fitness on cerebrovascular function in young adults using multiple inversion time arterial spin labeling MRI. *Front Physiol* 11, 2020. doi: 10.3389/fphys.2020.00360.
41. **Intzandt B, Sabra D, Foster C, Desjardins-Cr peau L, Hoge RD, Steele CJ, Bherer L, Gauthier CJ.** Higher cardiovascular fitness level is associated with lower cerebrovascular reactivity and perfusion in healthy older adults. *J Cereb Blood Metabol* 40: 1468–1481, 2020. doi: 10.1177/0271678X19862873.
42. **Barnes JN, Taylor JL, Kluck BN, Johnson CP, Joyner MJ.** Cerebrovascular reactivity is associated with maximal aerobic capacity in healthy older adults. *J Appl Physiol* 114: 1383–1387, 2013. doi: 10.1152/jappphysiol.01258.2012.
43. **DuBose LE, Weng TB, Pierce GL, Wharff C, Reist L, Hamilton C, O’Deen A, Dubishar K, Lane-Cordova A, Voss MW.** Association between cardiorespiratory fitness and cerebrovascular reactivity to a breath-hold stimulus in older adults: influence of aerobic exercise training. *J Appl Physiol* 132: 1468–1479, 2022. doi: 10.1152/jappphysiol.00599.2021.
44. **Petterson JL, O’Brien MW, Johns JA, Chiasson J, Kimmerly DS.** Influence of prostaglandins and endothelial-derived hyperpolarizing factors on brachial and popliteal endothelial-dependent function in young adults. *J Appl Physiol* 130: 17–25, 2021. doi: 10.1152/jappphysiol.00698.2020.
45. **Bell PL, Kelley ET, McCoy SM, Credeur DP.** Influence of aerobic fitness on vasoreactivity in young men. *Eur J Appl Physiol* 117: 2075–2083, 2017. doi: 10.1007/s00421-017-3698-6.

46. **O'Brien MW, Johns JA, Robinson SA, Mekary S, Kimmerly DS.** Relationship between brachial and popliteal artery low-flow-mediated constriction in older adults: impact of aerobic fitness on vascular endothelial function. *J Appl Physiol* 127: 134–142, 2019. doi: 10.1152/jappphysiol.00092.2019.
47. **Brown JC, Gerhardt TE, Kwon E.** Risk Factors for Coronary Artery Disease [Online]. StatPearl Publishing <https://www.ncbi.nlm.nih.gov/books/NBK554410/>.
48. **Wilson PWF, D'Agostino RB, Levy D, Belanger AM, Silbershatz H, Kannel WB.** Prediction of coronary heart disease using risk factor categories. *Circulation* 97: 1837–1847, 1998. doi: 10.1161/01.CIR.97.18.1837.
49. **Huma S, TR, AF, MKT.** Modifiable and non-modifiable predisposing risk factors of myocardial infarction - a review. *J Pharm Sci* 4: 1649–1653, 2012.
50. **Dahlöf B.** Cardiovascular disease risk factors: Epidemiology and risk assessment. *Am J Cardiol* 105: 3A-9A, 2010. doi: 10.1016/j.amjcard.2009.10.007.
51. **Statistics Canada.** Canadian community health survey [Online]. *StatCanada*: 2023. <https://www23.statcan.gc.ca/imdb/p2SV.pl?Function=getSurvey&SDDS=3226>.
52. **Anderson E, Durstine JL.** Physical activity, exercise, and chronic diseases: A brief review. *Spor Med Health Sci* 1: 3–10, 2019. doi: 10.1016/j.smhs.2019.08.006.
53. **Ross R, Chaput J-P, Giangregorio LM, Janssen I, Saunders TJ, Kho ME, Poitras VJ, Tomasone JR, El-Kotob R, McLaughlin EC, Duggan M, Carrier J, Carson V, Chastin SF, Latimer-Cheung AE, Chulak-Bozzer T, Faulkner G, Flood SM, Gazendam MK, Healy GN, Katzmarzyk PT, Kennedy W, Lane KN, Lorbergs A, Maclaren K, Marr S, Powell KE, Rhodes RE, Ross-White A, Welsh F, Willumsen J, Tremblay MS.** Canadian 24-Hour Movement Guidelines

for Adults aged 18–64 years and Adults aged 65 years or older: an integration of physical activity, sedentary behaviour, and sleep. *Appl Physiol Nutr Metabol* 45: S57–S102, 2020. doi: 10.1139/apnm-2020-0467.

54. **Jetté M, Sidney K, Blümchen G.** Metabolic equivalents (METs) in exercise testing, exercise prescription, and evaluation of functional capacity. *Clin Cardiol* 13: 555–565, 1990. doi: 10.1002/clc.4960130809.
55. **Moore SC, Patel A V, Matthews CE, Berrington de Gonzalez A, Park Y, Katki HA, Linet MS, Weiderpass E, Visvanathan K, Helzlsouer KJ, Thun M, Gapstur SM, Hartge P, Lee I-M.** Leisure time physical activity of moderate to vigorous intensity and mortality: A large pooled cohort analysis. *PLoS Med* 9: e1001335, 2012. doi: 10.1371/journal.pmed.1001335.
56. **Franklin BA, McCullough PA.** Cardiorespiratory fitness: an independent and additive marker of risk stratification and health outcomes. *Mayo Clin Proc* 84: 776–9, 2009. doi: 10.1016/S0025-6196(11)60486-2.
57. **Carnethon MR.** Cardiorespiratory fitness in young adulthood and the development of cardiovascular disease risk factors. *Journal of American Medical Association* 290: 3092, 2003. doi: 10.1001/jama.290.23.3092.
58. **Al-Mallah MH, Sakr S, Al-Qunaibet A.** Cardiorespiratory fitness and cardiovascular disease prevention: An update. *Curr Atheroscler Rep* 20: 1, 2018. doi: 10.1007/s11883-018-0711-4.
59. **Harber MP, Kaminsky LA, Arena R, Blair SN, Franklin BA, Myers J, Ross R.** Impact of cardiorespiratory fitness on all-cause and disease-specific mortality: Advances since 2009. *Prog Cardiovasc Dis* 60: 11–20, 2017. doi: 10.1016/j.pcad.2017.03.001.

60. **Laukkanen JA, Zaccardi F, Khan H, Kurl S, Jae SY, Rauramaa R.** Long-term change in cardiorespiratory fitness and all-cause mortality. *Mayo Clin Proc* 91: 1183–1188, 2016. doi: 10.1016/j.mayocp.2016.05.014.
61. **O'Brien MW, Shivgulam ME, Petterson JL, Wu Y, Frayne RJ, Mekari S, Kimmerly DS.** Habitual sedentary time and stationary time are inversely related to aerobic fitness. *Sports Med Health Sci* 4: 260–266, 2022. doi: 10.1016/j.smhs.2022.10.002.
62. **Naylor M, Chernofsky A, Spartano NL, Tanguay M, Blodgett JB, Murthy VL, Malhotra R, Houstis NE, Velagaleti RS, Murabito JM, Larson MG, Vasan RS, Shah R V, Lewis GD.** Physical activity and fitness in the community: the Framingham Heart Study. *Eur Heart J* 42: 4565–4575, 2021. doi: 10.1093/eurheartj/ehab580.
63. **Wang Y, Li F, Cheng Y, Gu L, Xie Z.** Cardiorespiratory fitness as a quantitative predictor of the risk of stroke: a dose–response meta-analysis. *J Neurol* 267: 491–501, 2020. doi: 10.1007/s00415-019-09612-6.
64. **Meschia JF, Bushnell C, Boden-Albala B, Braun LT, Bravata DM, Chaturvedi S, Creager MA, Eckel RH, Elkind MSV, Fornage M, Goldstein LB, Greenberg SM, Horvath SE, Iadecola C, Jauch EC, Moore WS, Wilson JA.** Guidelines for the primary prevention of stroke. *Stroke* 45: 3754–3832, 2014. doi: 10.1161/STR.0000000000000046.
65. **Hussain N, Gersh BJ, Gonzalez Carta K, Sydó N, Lopez-Jimenez F, Kopecky SL, Thomas RJ, Asirvatham SJ, Allison TG.** Impact of cardiorespiratory fitness on frequency of atrial fibrillation, stroke, and all-cause mortality. *Am J Cardiol* 121: 41–49, 2018. doi: 10.1016/j.amjcard.2017.09.021.
66. **Braz ID, Flück D, Lip GYH, Lundby C, Fisher JP.** Impact of aerobic fitness on cerebral blood flow and cerebral vascular responsiveness to CO₂ in young and older men. *Scand J Med Sci Sports* 27: 634–642, 2017. doi: 10.1111/sms.12674.

67. **LaMonte MJ, Barlow CE, Jurca R, Kampert JB, Church TS, Blair SN.** Cardiorespiratory fitness is inversely associated with the incidence of metabolic syndrome. *Circulation* 112: 505–512, 2005. doi: 10.1161/CIRCULATIONAHA.104.503805.
68. **Bye A, Røsjø H, Aspenes ST, Condorelli G, Omland T, Wisløff U.** Circulating microRNAs and aerobic fitness – The HUNT-Study. *PLoS One* 8: e57496, 2013. doi: 10.1371/journal.pone.0057496.
69. **Nystoriak MA, Bhatnagar A.** Cardiovascular effects and benefits of exercise. *Front Cardiovasc Med* 5, 2018. doi: 10.3389/fcvm.2018.00135.
70. **Stanfield CL.** The cardiovascular system: Cardiac function. In: *Prin H Physiol*. Pearson Education Inc. , 2017, p. 359–392.
71. **Klabunde RE.** Introduction to the cardiovascular system. In: *Cardiovasc Physiol*. Ohio: Wolters Kluwer, 2012, p. 1–8.
72. **Tucker WD, Arora Y, Mahajan K.** Anatomy, blood vessels [Online]. StatPearls Publishing. <https://www.ncbi.nlm.nih.gov/books/NBK470401/>.
73. **Klabunde R.** Cellular structure and function. In: *Cardiovasc Physiol*. Wolters Kluwer, 2012, p. 41–59.
74. **Witter K, Tonar Z, Schöpfer H.** How many layers has the adventitia? - Structure of the arterial tunica externa revisited. *Anat Histol Embryol* 46: 110–120, 2017. doi: 10.1111/ahe.12239.
75. **Galley HF, Webster NR.** Physiology of the endothelium. *Br J Anaesth* 93: 105–113, 2004. doi: 10.1093/bja/aeh163.

76. **Greenwald S.** Ageing of the conduit arteries. *J Pathol* 211: 157–172, 2007. doi: 10.1002/path.2101.
77. **Rahman M, Siddik AB.** Anatomy, Arterioles [Online]. *StatPearls* StatPearls Publishing: 2023. <https://www.ncbi.nlm.nih.gov/books/NBK555921/>.
78. **Klabunde R.** Vascular function. In: *Cardiovasc Physiol*. Wolters Kluwer, 2012, p. 93–123.
79. **Hainsworth R.** The importance of vascular capacitance in cardiovascular control. *Physiology* 5: 250–254, 1990. doi: 10.1152/physiologyonline.1990.5.6.250.
80. **Zhao Y, Vanhoutte PM, Leung SWS.** Vascular nitric oxide: Beyond eNOS. *J Pharmacol Sci* 129: 83–94, 2015. doi: 10.1016/j.jphs.2015.09.002.
81. **Wilson DP.** Vascular smooth muscle structure and function. In: *Mech Vasc Dises*, edited by Fitridge R, Thompson M. Adelaide: 2011.
82. **Cooper GM.** Actin, myosin and cell movement. In: *Cell: Molecul Appr*. Sunderland: Sinauer Associates , 2000.
83. **Stanfield CL.** Chemical messengers. In: *Prin H Physiol*. Pearson Education Inc., 2017, p. 124–147.
84. **Thomas GD.** Neural control of the circulation. *Adv Physiol Edu* 35: 28–32, 2011. doi: 10.1152/ADVAN.00114.2010.
85. **Fisher JP, Young CN, Fadel PJ.** Central sympathetic overactivity: Maladies and mechanisms. *Auto Neurosci* 148: 5–15, 2009. doi: 10.1016/j.autneu.2009.02.003.

86. **Stanfield C.** The nervous system: Central nervous system. In: *Prin H Physiol*. 2017, p. 215–252.
87. **Klabunde R.** Neurohumoral control of the heart and circulation. In: *Cardiovasc Physiol*. Wolters Kluwer, 2012, p. 124–147.
88. **Sheng Y, Zhu L.** The crosstalk between autonomic nervous system and blood vessels. *Int J Physiol Pathophysiol Pharmacol* 10: 17–28, 2018.
89. **Rummery NM, Brock JA, Pakdeechote P, Ralevic V, Dunn WR.** ATP is the predominant sympathetic neurotransmitter in rat mesenteric arteries at high pressure. *J Physiol* 582: 745, 2007. doi: 10.1113/JPHYSIOL.2007.134825.
90. **Tan CMJ, Green P, Tapoulal N, Lewandowski AJ, Leeson P, Herring N.** The role of neuropeptide Y in cardiovascular health and disease. *Front Physiol* 9: 1281, 2018. doi: 10.3389/FPHYS.2018.01281.
91. **Sandoo A, Veldhuijzen van Zanten JJCS, Metsios GS, Carroll D, Kitas GD.** The endothelium and its role in regulating vascular tone. *Open Cardiovasc Med J* 4: 302–312, 2010. doi: 10.2174/1874192401004010302.
92. **Smith DL, FB.** Vascular structure and function. In: *Adv Cardiovasc Exer Physiol*. Champaign, IL: 2011.
93. **Nagao T, Vanhoutte PM.** Endothelium-derived hyperpolarizing factor and endothelium-dependent relaxations. *Am J Respir Cell Mol Biol* 8: 1–6, 1993. doi: 10.1165/ajrcmb/8.1.1.
94. **Bourque SL, Davidge ST, Adams MA.** The interaction between endothelin-1 and nitric oxide in the vasculature: New perspectives. *Am J Physiol-Regul Integr Comp Physiol* 300: R1288–R1295, 2011. doi: 10.1152/ajpregu.00397.2010.

95. **Davenport AP, Hyndman KA, Dhaun N, Southan C, Kohan DE, Pollock JS, Pollock DM, Webb DJ, Maguire JJ.** Endothelin. *Pharmacol Rev* 68: 357–418, 2016. doi: 10.1124/pr.115.011833.
96. **Rubanyi GM, Polokoff MA.** Endothelins: molecular biology, biochemistry, pharmacology, physiology, and pathophysiology. *Pharmacol Rev* 46: 325–415, 1994.
97. **Spieker LE, Lüscher TF, Noll G.** ETA receptors mediate vasoconstriction of large conduit arteries during reduced flow in humans. *J Cardiovasc Pharmacol* 42: 315–318, 2003. doi: 10.1097/00005344-200309000-00001.
98. **Gori T, Dragoni S, Lisi M, Di Stolfo G, Sonnati S, Fineschi M, Parker JD.** Conduit artery constriction mediated by low flow. *J Am Coll Cardiol* 51: 1953–1958, 2008. doi: 10.1016/j.jacc.2008.01.049.
99. **Naseem K.** The role of nitric oxide in cardiovascular diseases. *Mol Aspects Med* 26: 33–65, 2005. doi: 10.1016/j.mam.2004.09.003.
100. **Loscalzo J, Jin.** Vascular nitric oxide: formation and function. *J Blood Med* 1: 147–162, 2010. doi: 10.2147/JBM.S7000.
101. **Gori T, Grotti S, Dragoni S, Lisi M, Di Stolfo G, Sonnati S, Fineschi M, Parker JD.** Assessment of vascular function: flow-mediated constriction complements the information of flow-mediated dilatation. *Heart* 96: 141–147, 2010. doi: 10.1136/hrt.2009.167213.
102. **Kleschyov AL, Oelze M, Daiber A, Huang Y, Mollnau H, Schulz E, Sydow K, Fichtlscherer B, Mülsch A, Münzel T.** Does nitric oxide mediate the vasodilator activity of nitroglycerin? *Circ Res* 93, 2003. doi: 10.1161/01.RES.0000100067.62876.50.

103. **Raitakari OT, Seale JP, Celermajer DS.** Impaired vascular responses to nitroglycerin in subjects with coronary atherosclerosis. *Am J Cardiol* 87: 217–219, 2001. doi: 10.1016/S0002-9149(00)01321-7.
104. **DeMers D, WD.** Physiology, mean arterial pressure [Online]. *StatPearls*: 2023. <https://www.ncbi.nlm.nih.gov/books/NBK538226/>.
105. **Wehrwein EA, Joyner MJ.** Regulation of blood pressure by the arterial baroreflex and autonomic nervous system. In: *Handb Clin Neurol*. 2013, p. 89–102.
106. **Chandra A, Li W, Stone C, Geng X, Ding Y.** The cerebral circulation and cerebrovascular disease I: Anatomy. *Brain Circ* 3: 45, 2017. doi: 10.4103/bc.bc_10_17.
107. **Zarrinkoob L, Ambarki K, Wåhlin A, Birgander R, Eklund A, Malm J.** Blood flow distribution in cerebral arteries. *J Cereb Blood Metabol* 35: 648–654, 2015. doi: 10.1038/jcbfm.2014.241.
108. **Konan LM RVMFB.** Neuroanatomy, cerebral blood supply. In: *StatPearls (Internet)* : 2023.
109. **Vrselja Z, Brkic H, Mrdenovic S, Radic R, Curic G.** Function of circle of willis. *J Cereb Blood Metabol* 34: 578–584, 2014. doi: 10.1038/jcbfm.2014.7.
110. **Rosner J, RV, FL.** Neuroanatomy, circle of willis [Online]. *StatPearls (Internet)* : 2023. <https://www.ncbi.nlm.nih.gov/books/NBK534861/>.
111. **Faraci FM, Heistad DD.** Regulation of large cerebral arteries and cerebral microvascular pressure. *Circ Res* 66: 8–17, 1990. doi: 10.1161/01.RES.66.1.8.

112. **Cipolla MJ.** Anatomy and ultrastructure. In: *Cereb Circul.* San Rafael: Morgan & Claypool Life Sciences , 2009.
113. **Bell R, Severson MA, Armonda RA.** Neurovascular anatomy: A practical guide. *Neurosurg Clin N Am* 20: 265–278, 2009. doi: 10.1016/j.nec.2009.04.012.
114. **Wahl M, Schilling L.** Regulation of cerebral blood flow--a brief review. *Acta Neurochir Suppl (Wien)* 59: 3–10, 1993. doi: 10.1007/978-3-7091-9302-0_1/COVER.
115. **Brassard P, Tymko MM, Ainslie PN.** Sympathetic control of the brain circulation: Appreciating the complexities to better understand the controversy. *Autonom Neurosci* 207: 37–47, 2017. doi: 10.1016/j.autneu.2017.05.003.
116. **LeBouef T, Yaker Z, Whited L.** *Physiology, autonomic nervous system.* 2023.
117. **Hamner JW, Tan CO, Lee K, Cohen MA, Taylor JA.** Sympathetic control of the cerebral vasculature in humans. *Stroke* 41: 102–109, 2010. doi: 10.1161/STROKEAHA.109.557132.
118. **Ogoh S, Brothers RM, Eubank WL, Raven PB.** Autonomic neural control of the cerebral vasculature. *Stroke* 39: 1979–1987, 2008. doi: 10.1161/STROKEAHA.107.510008.
119. **Koep JL, Taylor CE, Coombes JS, Bond B, Ainslie PN, Bailey TG.** Autonomic control of cerebral blood flow: fundamental comparisons between peripheral and cerebrovascular circulations in humans. *J Physiol* 600: 15–39, 2022. doi: 10.1113/JP281058.
120. **Vavilala MS, Lee LA, Lam AM.** Cerebral blood flow and vascular physiology. *Anesthesiol Clin North Am* 20: 247–264, 2002. doi: 10.1016/S0889-8537(01)00012-8.

121. **Joo F.** Endothelial cells of the brain and other organ systems: Some similarities and differences. *Prog Neurobiol* 48: 255–273, 1996. doi: 10.1016/0301-0082(95)00046-1.
122. **Brian JE, Faraci FM, Heistad DD.** Recent insights into the regulation of cerebral circulation. *Clin Exp Pharmacol Physiol* 23: 449–457, 1996. doi: 10.1111/j.1440-1681.1996.tb02760.x.
123. **Wasserman AJ, Patterson JL.** The cerebral vascular response to reduction in arterial carbon dioxide tension. *J Clin Invest* 40: 1297–1303, 1961. doi: 10.1172/JCI104359.
124. **Ellis MJ, Ryner LN, Sobczyk O, Fierstra J, Mikulis DJ, Fisher JA, Duffin J, Mutch WAC.** Neuroimaging assessment of cerebrovascular reactivity in concussion: Current concepts, methodological considerations, and review of the literature. *Front Neurol* 7, 2016. doi: 10.3389/fneur.2016.00061.
125. **Farrukh IS, Gurtner GH, Terry PB, Tohidi W, Yang JN, Adkinson NF, Michael JR.** Effect of pH on pulmonary vascular tone, reactivity, and arachidonate metabolism. *J Appl Physiol* 67: 445–452, 1989. doi: 10.1152/jappl.1989.67.1.445.
126. **Ainslie PN, Duffin J.** Integration of cerebrovascular CO₂ reactivity and chemoreflex control of breathing: mechanisms of regulation, measurement, and interpretation. *Amer J Physiol Regul Compar Physiol* 296: R1473–R1495, 2009. doi: 10.1152/ajpregu.91008.2008.
127. **Thompson BG, Pluta RM, Girton ME, Oldfield EH.** Nitric oxide mediation of chemoregulation but not autoregulation of cerebral blood flow in primates. *J Neurosurg* 84: 71–78, 1996. doi: 10.3171/jns.1996.84.1.0071.

128. **Joris P, Mensink R, Adam T, Liu T.** Cerebral blood flow measurements in adults: A review on the effects of dietary factors and exercise. *Nutrients* 10: 530, 2018. doi: 10.3390/nu10050530.
129. **Aaslid R, Markwalder T-M, Nornes H.** Noninvasive transcranial Doppler ultrasound recording of flow velocity in basal cerebral arteries. *J Neurosurg* 57: 769–774, 1982. doi: 10.3171/jns.1982.57.6.0769.
130. **Vicenzini E, Ricciardi MC, Altieri M, Puccinelli F, Bonaffini N, Di Piero V, Lenzi GL.** Cerebrovascular reactivity in degenerative and vascular dementia: A transcranial doppler study. *Eur Neurol* 58: 84–89, 2007. doi: 10.1159/000103642.
131. **Aguilar-Navarro SG, Mimenza-Alvarado AJ, Corona-Sevilla I, Jiménez-Castillo GA, Juárez-Cedillo T, Ávila-Funes JA, Román GC.** Cerebral vascular reactivity in frail older adults with vascular cognitive impairment. *Brain Sci* 9: 214, 2019. doi: 10.3390/brainsci9090214.
132. **Willie CK, Colino FL, Bailey DM, Tzeng YC, Binsted G, Jones LW, Haykowsky MJ, Bellapart J, Ogoh S, Smith KJ, Smirl JD, Day TA, Lucas SJ, Eller LK, Ainslie PN.** Utility of transcranial Doppler ultrasound for the integrative assessment of cerebrovascular function. *J Neurosci Methods* 196: 221–237, 2011. doi: 10.1016/j.jneumeth.2011.01.011.
133. **Purkayastha S, Sorond F.** Transcranial doppler ultrasound: Technique and application. *Semin Neurol* 32: 411–420, 2013. doi: 10.1055/s-0032-1331812.
134. **Johnston AJ, Steiner LA, Gupta AK, Menon DK.** Cerebral oxygen vasoreactivity and cerebral tissue oxygen reactivity . *Br J Anaesth* 90: 774–786, 2003. doi: 10.1093/bja/aeg104.
135. **Liu P, Xu C, Lin Z, Sur S, Li Y, Yasar S, Rosenberg P, Albert M, Lu H.** Cerebrovascular reactivity mapping using intermittent breath modulation. *Neuroimage* 215: 116787, 2020. doi: 10.1016/j.neuroimage.2020.116787.

136. **Murphy K, Harris AD, Wise RG.** Robustly measuring vascular reactivity differences with breath-hold: Normalising stimulus-evoked and resting state BOLD fMRI data. *Neuroimage* 54: 369–379, 2011. doi: 10.1016/j.neuroimage.2010.07.059.
137. **Thijssen DHJ, Carter SE, Green DJ.** Arterial structure and function in vascular ageing: are you as old as your arteries? *J Physiol* 594: 2275–2284, 2016. doi: 10.1113/JP270597.
138. **Kohn JC, Lampi MC, Reinhart-King CA.** Age-related vascular stiffening: causes and consequences. *Front Genet* 6, 2015. doi: 10.3389/fgene.2015.00112.
139. **Lubos E.** Role of oxidative stress and nitric oxide in atherothrombosis. *Front Biosci* Volume: 5323, 2008. doi: 10.2741/3084.
140. **Landim MBP, Filho AC, Chagas ACP.** Asymmetric dimethylarginine (ADMA) and endothelial dysfunction: Implications for atherogenesis. *Clinics* 64: 471–478, 2009. doi: 10.1590/S1807-59322009000500015.
141. **Beckman JS, Koppenol WH.** Nitric oxide, superoxide, and peroxynitrite: the good, the bad, and ugly. *Amer J Physiol-Cell* 271: C1424–C1437, 1996. doi: 10.1152/ajpcell.1996.271.5.C1424.
142. **Black MA, Cable NT, Thijssen DHJ, Green DJ.** Impact of age, sex, and exercise on brachial artery flow-mediated dilatation. *Amer J Physiol Heart Circul Physiol* 297: H1109–H1116, 2009. doi: 10.1152/ajpheart.00226.2009.
143. **Montero D, Pierce GL, Stehouwer CDA, Padilla J, Thijssen DHJ.** The impact of age on vascular smooth muscle function in humans. *J Hypertens* 33: 445–453, 2015. doi: 10.1097/HJH.0000000000000446.

144. **Klöss S, Bouloumié A, Mülsch A.** Aging and chronic hypertension decrease expression of rat aortic soluble guanylyl cyclase. *Hypertension* 35: 43–7, 2000.
145. **Zhong C, Xu M, Boral S, Summer H, Lichtenberger F-B, Erdoğan C, Gollasch M, Golz S, Persson PB, Schleifenbaum J, Patzak A, Khedkar PH.** Age impairs soluble guanylyl cyclase function in mouse mesenteric arteries. *Int J Mol Sci* 22: 11412, 2021. doi: 10.3390/ijms222111412.
146. **Schulz E, Tsilimingas N, Rinze R, Reiter B, Wendt M, Oelze M, Woelken-Weckmüller S, Walter U, Reichenspurner H, Meinertz T, Münzel T.** Functional and biochemical analysis of endothelial (Dys)function and NO/cGMP signaling in human blood vessels with and without nitroglycerin pretreatment. *Circulation* 105: 1170–1175, 2002. doi: 10.1161/hc1002.105186.
147. **Coverdale NS, Badrov MB, Shoemaker JK.** Impact of age on cerebrovascular dilation versus reactivity to hypercapnia. *J Cereb Blood Metabol* 37: 344–355, 2017. doi: 10.1177/0271678X15626156.
148. **Portegies MLP, de Bruijn RFAG, Hofman A, Koudstaal PJ, Ikram MA.** Cerebral vasomotor reactivity and risk of mortality. *Stroke* 45: 42–47, 2014. doi: 10.1161/STROKEAHA.113.002348.
149. **Peng S-L, Chen X, Li Y, Rodrigue KM, Park DC, Lu H.** Age-related changes in cerebrovascular reactivity and their relationship to cognition: A four-year longitudinal study. *Neuroimage* 174: 257–262, 2018. doi: 10.1016/j.neuroimage.2018.03.033.
150. **Lu H, Xu F, Rodrigue KM, Kennedy KM, Cheng Y, Flicker B, Hebrank AC, Uh J, Park DC.** Alterations in cerebral metabolic rate and blood supply across the adult lifespan. *Cereb Cortex* 21: 1426–1434, 2011. doi: 10.1093/cercor/bhq224.

151. **Early KS, Stewart A, Johannsen N, Lavie CJ, Thomas JR, Welsh M.** The effects of exercise training on brachial artery flow-mediated dilation. *J Cardiopulm Rehabil Prev* 37: 77–89, 2017. doi: 10.1097/HCR.0000000000000206.
152. **Schuler G, Adams V, Goto Y.** Role of exercise in the prevention of cardiovascular disease: results, mechanisms, and new perspectives. *Eur Heart J* 34: 1790–1799, 2013. doi: 10.1093/eurheartj/eh111.
153. **O'Brien MW, Mekary S, Robinson SA, Johns JA, Kimmerly DS.** The relationship between aerobic fitness and low-flow-mediated constriction in older adults. *Eur J Appl Physiol* 119: 351–359, 2019. doi: 10.1007/s00421-018-4044-3.
154. **Buscemi S, Canino B, Batsis JA, Buscemi C, Calandrino V, Mattina A, Arnone M, Caimi G, Cerasola G, Verga S.** Relationships between maximal oxygen uptake and endothelial function in healthy male adults: a preliminary study. *Acta Diabetol* 50: 135–141, 2013. doi: 10.1007/s00592-010-0229-x.
155. **O'Brien MW, Robinson SA, Frayne R, Mekary S, Fowles JR, Kimmerly DS.** Achieving Canadian physical activity guidelines is associated with better vascular function independent of aerobic fitness and sedentary time in older adults. *Applied Physiology, Nutrition and Metabolism* 43: 1003–1009, 2018. doi: 10.1139/apnm-2018-0033.
156. **Garber CE, Blissmer B, Deschenes MR, Franklin BA, Lamonte MJ, Lee I-M, Nieman DC, Swain DP.** Quantity and quality of exercise for developing and maintaining cardiorespiratory, musculoskeletal, and neuromotor fitness in apparently healthy adults. *Med Sci Sports Exerc* 43: 1334–1359, 2011. doi: 10.1249/MSS.0b013e318213febf.
157. **O'Brien MW, Johns JA, Robinson SA, Bungay A, Mekary S, Kimmerly DS.** Impact of high-intensity interval training, moderate-intensity continuous training, and resistance training on endothelial function in older adults. *Med Sci Sports Exerc* 52: 1057–1067, 2020. doi: 10.1249/MSS.0000000000002226.

158. **Maruhashi T, Kajikawa M, Kishimoto S, Hashimoto H, Takaeko Y, Yamaji T, Harada T, Han Y, Aibara Y, Mohamad Yusoff F, Hidaka T, Kihara Y, Chayama K, Nakashima A, Goto C, Tomiyama H, Takase B, Kohro T, Suzuki T, Ishizu T, Ueda S, Yamazaki T, Furumoto T, Kario K, Inoue T, Koba S, Watanabe K, Takemoto Y, Hano T, Sata M, Ishibashi Y, Node K, Maemura K, Ohya Y, Furukawa T, Ito H, Ikeda H, Yamashina A, Higashi Y.** Diagnostic criteria of flow-mediated vasodilation for normal endothelial function and nitroglycerin-induced vasodilation for normal vascular smooth muscle function of the brachial artery. *J Am Heart Assoc* 9, 2020. doi: 10.1161/JAHA.119.013915.
159. **Santos-García D, Blanco M, Serena J, Arias S, Millán M, Rodríguez-Yáñez M, Leira R, Dávalos A, Castillo J.** Brachial arterial flow mediated dilation in acute ischemic stroke. *Eur J Neurol* 16: 684–690, 2009. doi: 10.1111/j.1468-1331.2009.02564.x.
160. **Williams MRI, Westerman RA, Kingwell BA, Paige J, Blombery PA, Sudhir K, Komesaroff PA.** Variations in endothelial function and arterial compliance during the menstrual cycle. *J Clin Endocrinol Metab* 86: 5389–5395, 2001. doi: 10.1210/jcem.86.11.8013.
161. **Williams JS, Stimpson T V, Tremblay JC, Fenuta AM, Pyke KE.** The influence of acute hyperglycaemia on brachial artery flow-mediated dilatation in the early and late follicular phases of the menstrual cycle. *Exp Physiol* 104: 957–966, 2019. doi: 10.1113/EP087536.
162. **Hashimoto M, Akishita M, Eto M, Ishikawa M, Kozaki K, Toba K, Sagara Y, Taketani Y, Orimo H, Ouchi Y.** Modulation of endothelium-dependent flow-mediated dilatation of the brachial artery by sex and menstrual cycle. *Circulation* 92: 3431–3435, 1995. doi: 10.1161/01.CIR.92.12.3431.
163. **Thijssen DHJ, Bruno RM, van Mil ACCM, Holder SM, Fajta F, Greyling A, Zock PL, Taddei S, Deanfield JE, Luscher T, Green DJ, Ghiadoni L.** Expert consensus and evidence-based recommendations for the assessment of flow-mediated dilatation in humans. *Eur Heart J* 40: 2534–2547, 2019. doi: 10.1093/eurheartj/ehz350.

164. **Borg GA.** Psychophysical bases of perceived exertion. *Med Sci Sports Exerc* 14: 377–81, 1982.
165. **Tanaka H, Monahan KD, Seals DR.** Age-predicted maximal heart rate revisited. *J Am Coll Cardiol* 37: 153–156, 2001. doi: 10.1016/S0735-1097(00)01054-8.
166. **Liguori G.** *ACSM's Fitness Assessment Manual*. 5th ed. Philadelphia: Wolters Kluwer, 2018.
167. **Jones NL, Makrides L, Hitchcock C, Chypchar T, McCartney N.** Normal standards for an incremental progressive cycle ergometer test. *Am Rev Respir Dis* 131: 700–708, 1985. doi: 10.1164/ARRD.1985.131.5.700.
168. **CSEP.** Canadian Society for Exercise Physiology-Physical Activity Training for Health (CSEP-PATH). 2013.
169. **Edwardson CL, Winkler EAH, Bodicoat DH, Yates T, Davies MJ, Dunstan DW, Healy GN.** Considerations when using the activPAL monitor in field-based research with adult populations. *J Sport Health Sci* 6: 162–178, 2017. doi: 10.1016/j.jshs.2016.02.002.
170. **O'Brien MW, Johns JA, Fowles JR, Kimmerly DS.** Validity of the activPAL and height-adjusted curvilinear cadence-METs equations in healthy adults. *Meas Phys Educ Exerc Sci* 24: 147–156, 2020. doi: 10.1080/1091367X.2020.1724112.
171. **O'Brien MW, Kivell MJ, Wojcik WR, D'Entremont GR, Kimmerly DS, Fowles JR.** Influence of Anthropometrics on Step-Rate Thresholds for Moderate and Vigorous Physical Activity in Older Adults: Scientific Modeling Study. *JMIR Aging* 1: e12363, 2018. doi: 10.2196/12363.

172. **Alexandrov A V, Sloan MA, Wong LKS, Douville C, Razumovsky AY, Koroshetz WJ, Kaps M, Tegeler CH.** Practice standards for transcranial Doppler ultrasound: Part I-test performance. *J Neuroimag* 17: 11–18, 2007. doi: 10.1111/j.1552-6569.2006.00088.x.
173. **Hendee WR, Marc Edwards F.** ALARA and an integrated approach to radiation protection. *Semin Nucl Med* 16: 142–150, 1986. doi: 10.1016/S0001-2998(86)80027-7.
174. **McDonnell MN, Berry NM, Cutting MA, Keage HA, Buckley JD, Howe PRC.** Transcranial Doppler ultrasound to assess cerebrovascular reactivity: reliability, reproducibility and effect of posture. *PeerJ* 1: e65, 2013. doi: 10.7717/peerj.65.
175. **Padilla J, Johnson BD, Newcomer SC, Wilhite DP, Mickleborough TD, Fly AD, Mather KJ, Wallace JP.** Normalization of flow-mediated dilation to shear stress area under the curve eliminates the impact of variable hyperemic stimulus. *Cardiovasc Ultrasound* 6: 44, 2008. doi: 10.1186/1476-7120-6-44.
176. **Atkinson G, Batterham AM, Black MA, Cable NT, Hopkins ND, Dawson EA, Thijssen DHJ, Jones H, Tinken TM, Green DJ.** Is the ratio of flow-mediated dilation and shear rate a statistically sound approach to normalization in cross-sectional studies on endothelial function? *J Appl Physiol* 107: 1893–1899, 2009. doi: 10.1152/jappphysiol.00779.2009.
177. **Atkinson G, Batterham AM.** Allometric scaling of diameter change in the original flow-mediated dilation protocol. *Atherosclerosis* 226: 425–427, 2013. doi: 10.1016/j.atherosclerosis.2012.11.027.
178. **Kasikcioglu E, Oflaz H, Kasikcioglu HA, Kayserilioglu A, Umman S, Meric M.** Endothelial function in athletes 45 endothelial flow-mediated dilatation and exercise capacity in highly trained endurance athletes. *Tohoku J Exp Med* 205: 45–51, 2005.

179. **Akazawa N, Kumagai H, Yoshikawa T, Myoenzono K, Tanahashi K, Maeda S.** Cerebral blood flow velocity is associated with endothelial function in men. *J Mens Health* 17: 41–46, 2021. doi: 10.31083/jomh.2021.049.
180. **Zimmerman B, Rypma B, Gratton G, Fabiani M.** Age-related changes in cerebrovascular health and their effects on neural function and cognition: A comprehensive review. *Psychophysiology* 58, 2021. doi: 10.1111/PSYP.13796.
181. **Teragawa H, Ueda K, Matsuda K, Kimura M, Higashi Y, Oshima T, Yoshizumi M, Chayama K.** Relationship between endothelial function in the coronary and brachial arteries. *Clin Cardiol* 28: 460–466, 2005. doi: 10.1002/CLC.4960281004.
182. **Hoiland RL, Smith KJ, Carter HH, Lewis NCS, Tymko MM, Wildfong KW, Bain AR, Green DJ, Ainslie PN.** Shear-mediated dilation of the internal carotid artery occurs independent of hypercapnia. *Am J Physiol Heart Circ Physiol* 313: H24–H31, 2017. doi: 10.1152/AJPHEART.00119.2017/ASSET/IMAGES/LARGE/ZH40061722340005.JPEG.
183. **Betik AC, Hepple RT.** Determinants of VO₂ max decline with aging: an integrated perspective. <https://doi.org/10.1139/H07-174> 33: 130–140, 2008. doi: 10.1139/H07-174.
184. **Beltz NM, Gibson AL, Janot JM, Kravitz L, Mermier CM, Dalleck LC.** Graded exercise testing protocols for the determination of VO₂max: Historical perspectives, progress, and future considerations. *J Sport Med* 2016: 1–12, 2016. doi: 10.1155/2016/3968393.
185. **Alwatban MR, Aaron SE, Kaufman CS, Barnes JN, Brassard P, Ward JL, Miller KB, Howery AJ, Labrecque L, Billinger SA.** Effects of age and sex on middle cerebral artery blood velocity and flow pulsatility index across the adult lifespan. *J Appl Physiol* 130: 1675–1683, 2021. doi: 10.1152/jappphysiol.00926.2020.

186. **Hart EC, Charkoudian N, Wallin BG, Curry TB, Eisenach J, Joyner MJ.** Sex and ageing differences in resting arterial pressure regulation: the role of the β -adrenergic receptors. *J Physiol* 589: 5285–5297, 2011. doi: 10.1113/jphysiol.2011.212753.
187. **Joyner MJ, Barnes JN, Hart EC, Wallin BG, Charkoudian N.** Neural control of the circulation: How sex and age differences interact in humans. In: *Comprehensive Physiology*. Wiley, 2014, p. 193–215.
188. **Jurca R, Jackson AS, LaMonte MJ, Morrow JR, Blair SN, Wareham NJ, Haskell WL, van Mechelen W, Church TS, Jakicic JM, Laukkanen R.** Assessing cardiorespiratory fitness without performing exercise testing. *Am J Prev Med* 29: 185–193, 2005. doi: 10.1016/j.amepre.2005.06.004.
189. **Craighead DH, Freeberg KA, Seals DR.** The protective role of regular aerobic exercise on vascular function with aging. *Curr Opin Physiol* 10: 55–63, 2019. doi: 10.1016/j.cophys.2019.04.005.
190. **Novais IP, Jarrete AP, Puga GM, Araujo HN, Delbin MA, Zanesco A.** Effect of aerobic exercise training on cGMP levels and blood pressure in treated hypertensive postmenopausal women. *Motriz: Revista de Educação Física* 23: 1–6, 2017. doi: 10.1590/s1980-6574201700010001.
191. **Huang J, Zhang H, Tan X, Hu M, Shen B.** Exercise restores impaired endothelium-derived hyperpolarizing factor-mediated vasodilation in aged rat aortic arteries via the TRPV4-KCa2.3 signaling complex. *Clin Interv Aging* 14: 1579–1587, 2019. doi: 10.2147/CIA.S220283.
192. **Maeda S, Tanabe T, Miyauchi T, Otsuki T, Sugawara J, Iemitsu M, Kuno S, Ajisaka R, Yamaguchi I, Matsuda M.** Aerobic exercise training reduces plasma endothelin-1 concentration in older women. *J Appl Physiol* 95: 336–341, 2003. doi: 10.1152/jappphysiol.01016.2002.

193. **Van Guilder GP, Westby CM, Greiner JJ, Stauffer BL, DeSouza CA.** Endothelin-1 vasoconstrictor tone increases with age in healthy men but can be reduced by regular aerobic exercise. *Hypertension* 50: 403–409, 2007. doi: 10.1161/HYPERTENSIONAHA.107.088294.
194. **Johns JA, O'Brien MW, Bungay A, Kimmerly DS.** Sex and light physical activity impact popliteal, but not brachial artery flow-mediated dilation in physically active young adults. <https://doi.org/10.1139/apnm-2020-0308> 45: 1387–1395, 2020. doi: 10.1139/APNM-2020-0308.
195. **Fujii K, Heistad DD, Faraci FM.** Flow-mediated dilatation of the basilar artery in vivo. *Circ Res* 69: 697–705, 1991. doi: 10.1161/01.RES.69.3.697.
196. **Lee PH, Oh SH, Bang OY, Joo SY, Joo IS, Huh K.** Infarct patterns in atherosclerotic middle cerebral artery versus internal carotid artery disease. *Neurology* 62: 1291–1296, 2004. doi: 10.1212/01.WNL.0000120761.57793.28/ASSET/B2B41802-F96A-4816-BCC0-0A22D739BCE3/ASSETS/GRAPHIC/13FF1.JPEG.
197. **Babcock MC, DuBose LE, Witten TL, Brubaker A, Stauffer BL, Hildreth KL, Moreau KL.** Assessment of macrovascular and microvascular function in aging males. *J Appl Physiol* 130: 96, 2021. doi: 10.1152/JAPPLPHYSIOL.00616.2020.
198. **Serrador JM, Picot PA, Rutt BK, Shoemaker JK, Bondar RL.** MRI Measures of Middle Cerebral Artery Diameter in Conscious Humans During Simulated Orthostasis. *Stroke* 31: 1672–1678, 2000. doi: 10.1161/01.STR.31.7.1672.

Appendix A: Dalhousie HSREB Letter of Approval



Health|Sciences Research Ethics Board
Letter of Approval

May 01, 2023

Derek ~~Kimmerly~~
Health\School of Health and Human Performance

Dear Derek,

REB #: 2023-6585
Project Title: The Impact of Aerobic Fitness on Peripheral and Brain Artery Function

Effective Date: May 01, 2023
Expiry Date: May 01, 2024

The Health Sciences Research Ethics Board has reviewed your application for research involving humans and found the proposed research to be in accordance with the Tri-Council Policy Statement on *Ethical Conduct for Research Involving Humans*. This approval will be in effect for 12 months as indicated above. This approval is subject to the conditions listed below which constitute your on-going responsibilities with respect to the ethical conduct of this research.

Sincerely,

Dr. Jennifer ~~Isenor~~
Chair, Health Sciences Research Ethics Board
Dalhousie University

Appendix B: Supplemental Figure 1 – Aerobic Fitness & Brachial FMD vs Relative CVR

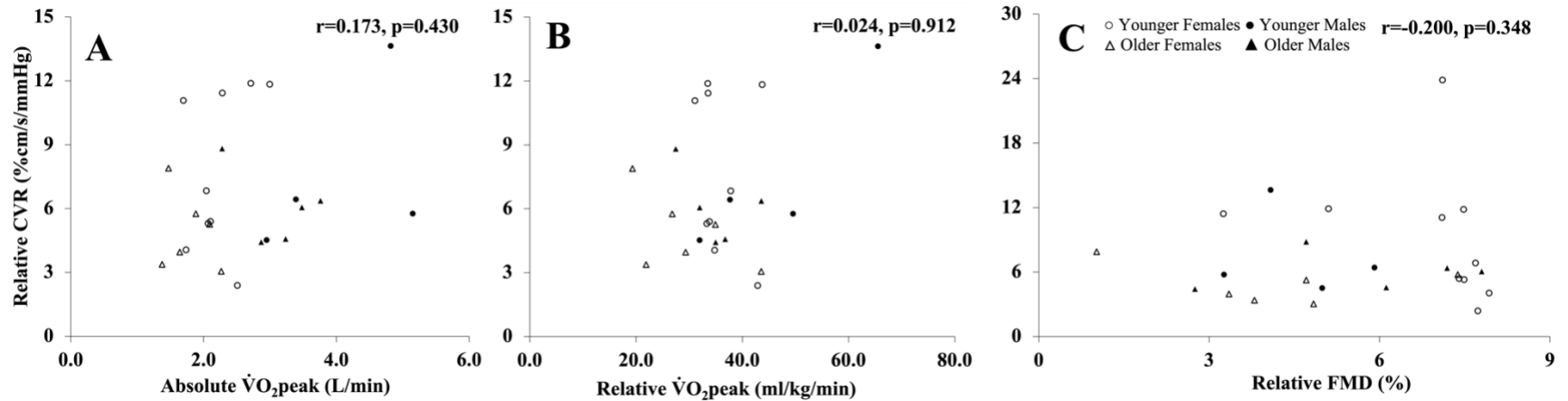

Supplemental Figure 1. Relationships between relative CVR and absolute $\dot{V}O_2$ peak (A), relative $\dot{V}O_2$ peak (B), and relative FMD (C). All assumptions for using Spearman's correlations were met.

Appendix C: Supplemental Figure 2 – Aerobic Fitness vs Resting MCAv & CVR

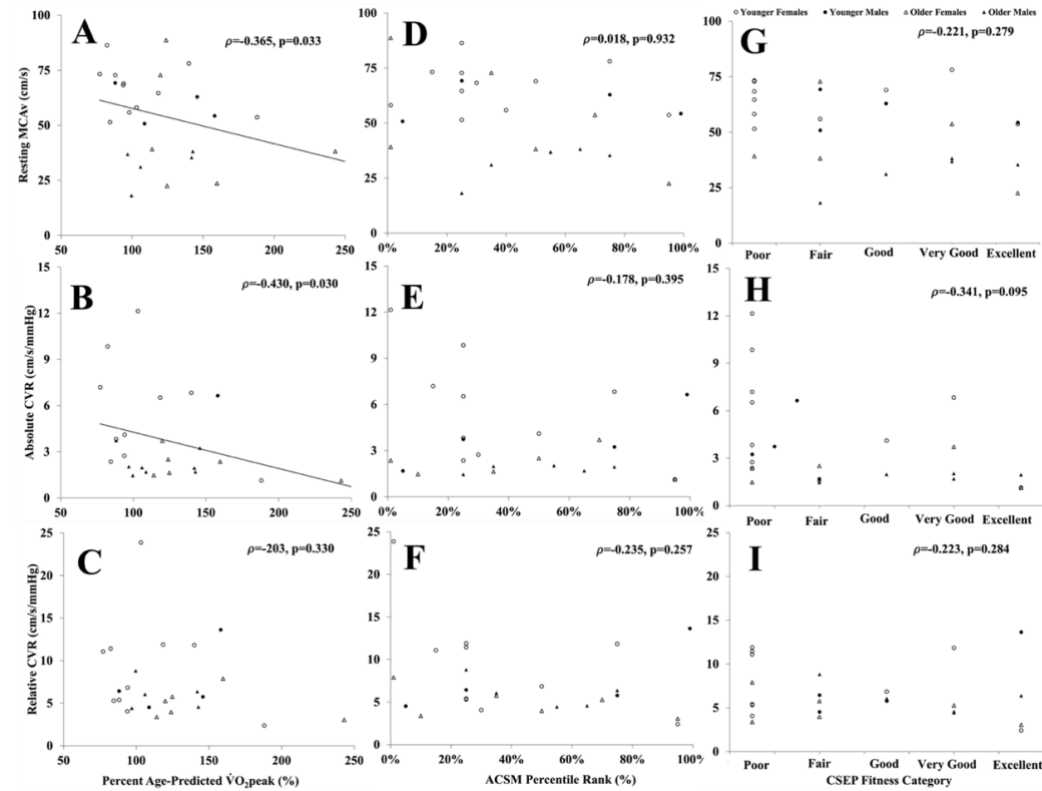

Supplemental Figure 2. Relationship between the percentage of age-predicted $\dot{V}O_{2peak}$ and MCAv (A), absolute CVR (B) and relative CVR (C); ACSM percentile rank and MCAv (D), absolute CVR (E), and relative CVR (F); CSEP fitness category and MCAv (G), absolute CVR (H), and relative CVR (I). Spearman rank correlations (ρ) were conducted on relationships. All assumptions for using Spearman's correlations were met.

Appendix D: Supplemental Figure 3 – Aerobic Fitness vs Brachial FMD & NMD

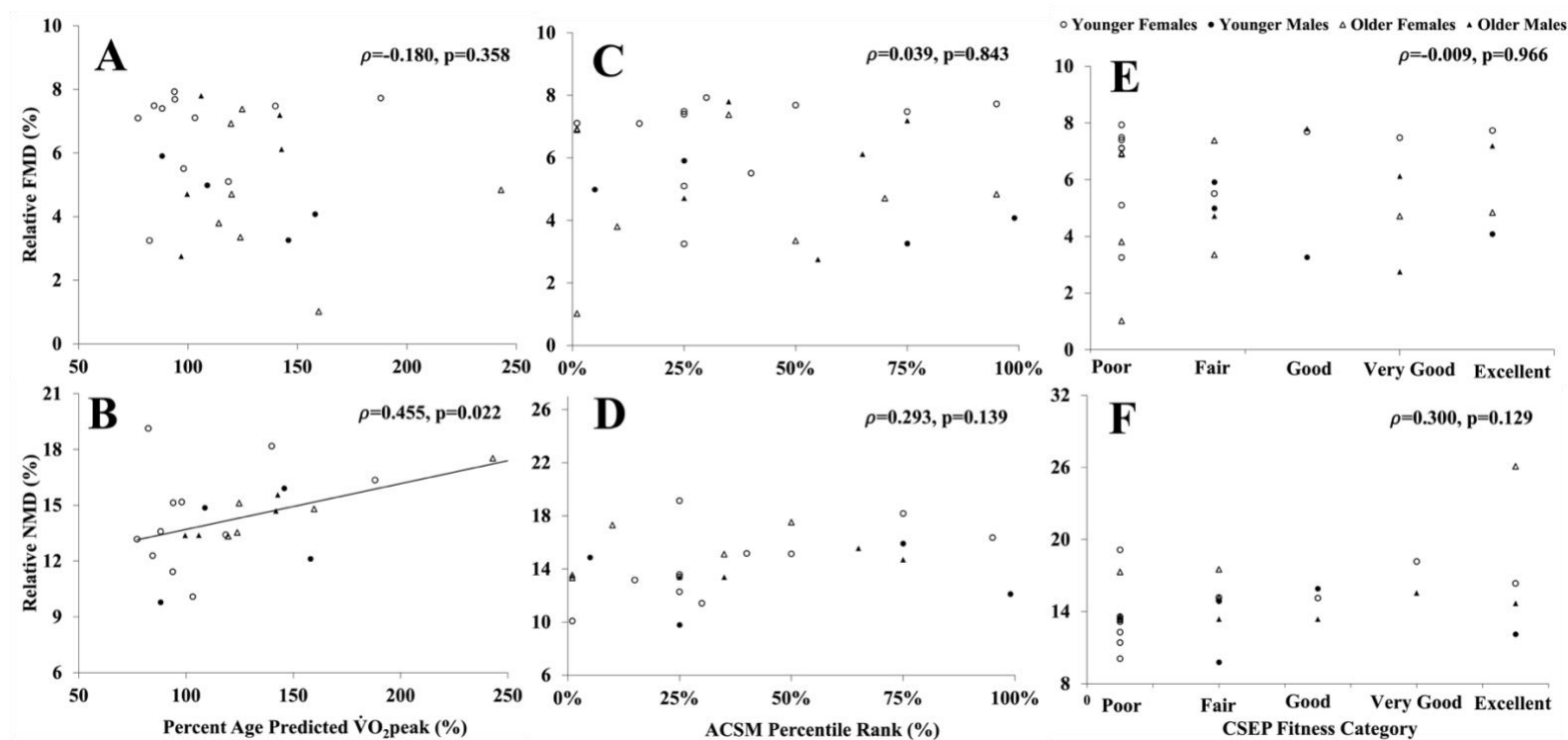

Supplemental Figure 3. Relationship between the percentage of age-predicted $\dot{V}O_{2peak}$ and relative FMD (A) and relative NMD (B); ACSM percentile rank and relative FMD (C) and relative NMD (D); CSEP fitness category and relative FMD (E) and relative NMD (F). Spearman rank correlations (ρ) were conducted on all relationships.