

**A STUDY OF CARBONATE ROCKS FROM THE LATE VISEAN TO NAMURIAN
MABOU GROUP, CAPE BRETON ISLAND, NOVA SCOTIA**

Tammy Lee Allen

Submitted in Partial Fulfilment of the Requirements
for the Degree of Bachelor of Science, Honours
Department of Earth Sciences
Dalhousie University, Halifax, Nova Scotia
April 1995

Distribution License

DalSpace requires agreement to this non-exclusive distribution license before your item can appear on DalSpace.

NON-EXCLUSIVE DISTRIBUTION LICENSE

You (the author(s) or copyright owner) grant to Dalhousie University the non-exclusive right to reproduce and distribute your submission worldwide in any medium.

You agree that Dalhousie University may, without changing the content, reformat the submission for the purpose of preservation.

You also agree that Dalhousie University may keep more than one copy of this submission for purposes of security, back-up and preservation.

You agree that the submission is your original work, and that you have the right to grant the rights contained in this license. You also agree that your submission does not, to the best of your knowledge, infringe upon anyone's copyright.

If the submission contains material for which you do not hold copyright, you agree that you have obtained the unrestricted permission of the copyright owner to grant Dalhousie University the rights required by this license, and that such third-party owned material is clearly identified and acknowledged within the text or content of the submission.

If the submission is based upon work that has been sponsored or supported by an agency or organization other than Dalhousie University, you assert that you have fulfilled any right of review or other obligations required by such contract or agreement.

Dalhousie University will clearly identify your name(s) as the author(s) or owner(s) of the submission, and will not make any alteration to the content of the files that you have submitted.

If you have questions regarding this license please contact the repository manager at dalspace@dal.ca.

Grant the distribution license by signing and dating below.

Name of signatory

Date



Dalhousie University

Department of Earth Sciences

Halifax, Nova Scotia

Canada B3H 3J5

(902) 494-2358

FAX (902) 494-6889

DATE 25-April-1995

AUTHOR Tammy Lee Allen

TITLE A Study of Carbonate Rocks from the Late Viséan to Namurian
Mabou Group, Cape Breton Island, Nova Scotia

Degree Honours BSc Convocation May Year 1995

Permission is herewith granted to Dalhousie University to circulate and to have copied for non-commercial purposes, at its discretion, the above title upon the request of individuals or institutions.

THE AUTHOR RESERVES OTHER PUBLICATION RIGHTS, AND NEITHER THE THESIS NOR EXTENSIVE EXTRACTS FROM IT MAY BE PRINTED OR OTHERWISE REPRODUCED WITHOUT THE AUTHOR'S WRITTEN PERMISSION.

THE AUTHOR ATTESTS THAT PERMISSION HAS BEEN OBTAINED FOR THE USE OF ANY COPYRIGHTED MATERIAL APPEARING IN THIS THESIS (OTHER THAN BRIEF EXCERPTS REQUIRING ONLY PROPER ACKNOWLEDGEMENT IN SCHOLARLY WRITING) AND THAT ALL SUCH USE IS CLEARLY ACKNOWLEDGED.

Abstract

The Late Viséan to Namurian Mabou Group of Cape Breton Island conformably overlies the marine to non-marine Windsor Group and unconformably to conformably underlies the fluvialite Cumberland Group. It represents the first non-marine to brackish sediments deposited after the retreat of Windsor seas. Regionally, the Mabou Group comprises two lithologic facies, a grey lacustrine facies and a red fluvialite facies. The grey facies, or lowermost unit, consists predominantly of grey siltstones and shales with interbedded sandstones, and thin carbonates, with gypsum near the base of the section. The grey facies forms the Hastings Formation in the Western Cape Breton Basin, the Cape Dauphin Formation in the Sydney Basin, and the MacKeigan Lake Formation in the Loch Lomond Basin. The upper unit, or the red facies, consists of red with minor green and grey sandstones, siltstones, shales, and minor pedogenic carbonates. Throughout the grey facies of the Mabou Group carbonate rocks occur. Lateral discontinuity of these carbonate rocks does not provide good lithostratigraphic correlations, although their ubiquitous presence in the grey facies of the Mabou Group serves to indicate stratigraphic position. These thin carbonate units consist of various types, ranging from wackestones to grainstones and contain intraclasts, ooids, serpulids, and peloids as constituents. Stromatolitic bindstones comprise the largest percentage of carbonates within the lower unit of the Mabou Group. Carbonate rocks and their associated sediments act as important paleoenvironmental indicators and suggest that deposition of the Mabou Group grey facies occurred within a shallow, subaqueous environment undergoing periods of subaerial exposure.

Key Words: lacustrine, Carboniferous, Mabou Group, stromatolites, ooids, carbonates

Table of Contents

Table of Contents.....	ii
List of Figures	iv
List of Tables.....	v
Acknowledgements	vi

Chapter 1: Introduction

1.1 Introduction	1
1.2 Purpose	1
1.3 Geological Setting	2
1.4 Previous Work on the Mabou Group	4
1.5 Scope	6
1.6 Organization	8

Chapter 2: Mabou Group Stratigraphy

2.1 Introduction	11
2.2 General Geology	11
2.2.1 Age	11
2.2.2 Type Section	12
2.2.3 Contact Relationships	12
2.2.4 Regional Extent	12
2.2.5 Subdivisions	13
2.3 Grey Facies of the Mabou Group	13
2.4 Red Facies of the Mabou Group	15
2.5 Summary	16

Chapter 3: Carbonate Rocks and Associated Lithofacies

3.1 Introduction	17
3.2 Classification	17
3.3 Carbonate Rocks	18
3.3.1 Stromatolites	19
3.3.2 Intraclasts	24
3.3.3 Ooids	26
3.3.4 Peloids	35
3.3.5 Serpulids	38
3.4 Associated Lithofacies	40
3.4.1 Siltstone	40

3.4.2. Sandstone	41
3.4.3 Gypsum	43
3.5 Summary	44

Chapter 4: Environmental Implications

4.1 Introduction	45
4.2 Carbonate Rocks	45
4.2.1 Stromatolites	46
4.2.2 Intraclasts	50
4.2.3 Ooids	53
4.2.4 Peloids	54
4.2.5 Serpulids	55
4.3 Associated Lithofacies	55
4.3.1 Siltstone	56
4.3.2 Sandstone	56
4.3.3 Gypsum	57
4.4 Summary	58

Chapter 5: Conclusions

5.1 Introduction	59
5.2 Depositional Environment	59
5.3 Facies Relationships	61
5.3.1 Shoreline Facies	62
5.3.2 Nearshore Facies	63
5.3.3 Offshore Facies	65
5.4 Conclusions.....	67
References	69
Appendix A (Section descriptions).....	A1
Appendix B (Stratigraphic section)	B1

List of Figures

Chapter 1: Introduction

1.1 Outline of Stratigraphic Revisions of the Mabou Group.....	5
1.2 Outline of Mabou Group Stratigraphy.....	7
1.3 Location Map	9

Chapter 3: Carbonate Rocks and Associated Lithofacies

3.1 Laterally Linked Hemispheroidal Stromatolite	20
3.2 Stratiform Stromatolite	21
3.3 Compound Stromatolite.....	22
3.4 Stromatolite	23
3.5 Intraclastic Carbonate.....	25
3.6 Intraclastic Grainstone	27
3.7 Intraclastic Packstone	28
3.8 Ooid Structure	29
3.9 Oolitic Packstone	31
3.10 Oolitic Serpulid Wackestone	32
3.11 Oolitic Grainstone with meniscus cement	33
3.12 Oolitic Grainstone	34
3.13 Peloidal Grainstone	36
3.14 Peloidal Grainstone	37
3.15 Serpulid Wackestone	39
3.16 Swaley siltstone	42

Chapter 4: Environmental Interpretations

4.1 Stromatolite Laminae.....	48
4.2 Ooid.....	52

Chapter 5: Discussion and Conclusions

5.1 Shoreline and Nearshore Facies	64
5.2 Offshore Facies	66

List of Tables

Chapter 3: Carbonate Rocks and Associated Lithofacies

3.1 Classification Scheme of Carbonate Rocks 18

Chapter 5: Discussion and Conclusions

5.1 Lacustrine Facies..... 63

Acknowledgements

I wish to thank Dr. Peter Giles for his excellent supervision, unending support, and encouragement throughout the project. I also wish to thank to Dr. Paul Schenk who contributed helpful advice, constructive criticism, and continuously reminded me to have fun with my thesis, and thanks to Dr. Barrie Clarke for his guidance and many thorough readings of the manuscript, and to Brian Creaser for help in measuring sections.

Chapter 1: Introduction

1.1 Introduction

Early to Middle Devonian events of the Acadian Orogeny formed low-lying basins throughout Cape Breton Island, the resulting basins filled with locally-derived sediments. These sediments accumulated in the basin as conglomerates, sandstones, and siltstones forming the Late Devonian Fisset Brook Formation, the Tournaisian Horton Group, the Viséan Windsor Group, and the Late Viséan to Namurian Mabou Group.

The Late Viséan to Namurian Mabou Group represents the first non-marine to brackish water sediments deposited above the marine Windsor Group of Cape Breton Island, Nova Scotia. Mabou Group deposits occur in Carboniferous sedimentary basins of Cape Breton, namely the Western Cape Breton, Sydney, and Loch Lomond Basins. The Mabou Group consists of two predominant lithologies, a grey lacustrine facies and a red fluvial facies. Within the fine-grained grey clastic rocks of the Mabou Group grey facies are a variety of carbonate rocks that in the past received very little attention. These carbonate rocks with their associated lithofacies provide important clues for interpreting the depositional environment and are the focus of this study.

1.2 Purpose

The main objectives of this study are to determine:

1. the types of carbonate rocks within the Mabou Group;
2. the stratigraphic positions of the carbonates and their relationship to associated lithofacies;
3. the depositional setting of the carbonate rocks; and
4. the facies relationships within the lower Mabou Group based on positions of the carbonate rocks

1.3 Geologic Setting

During Early to Middle Devonian time, deformation by compressional events of the Acadian Orogeny resulted in the formation of a complex rift-valley system throughout the Atlantic Provinces (Bell 1958). From Late Devonian to Early Carboniferous time, uplands supplied sediments to adjacent subsiding basins. The first sediments deposited in these basins included conglomerates, sandstones, and shales of the Upper Devonian Fisset Brook Formation. Widespread volcanism resulted in the intercalation of basaltic flows and rhyolitic volcanics with sedimentary rocks of the Fisset Brook Formation.

Horton Group sediments unconformably overlie the Fisset Brook Formation. Bell (1960) assigned the Horton Group a Tournaisian age based on its floral assemblages. Deposits of the lower Horton Group include red to green conglomerates and arkosic sandstones deposited as alluvial fans. Sediments deposited later include lacustrine grey fine-grained sandstone, siltstone, and shale deposits, as well as red and grey fluvial sandstones of the Upper Horton Group.

Deposition of the Windsor Group succeeded sedimentation of the Horton Group resulting in the accumulation of both marine and non-marine sediments. Deposits of the earliest Windsor Group are either disconformable or locally conformable on uppermost Horton Group rocks (Norman 1935). The Windsor Group is Viséan in age as suggested by palynostratigraphic correlations with Western Europe (Utting 1987). Windsor Group sedimentary rocks include repetitive sequences, each consisting of carbonates, gypsum/anhydrite, and red clastic rocks. These rocks were deposited in an arid to semi-arid setting undergoing cycles of marine transgression and regression.

After the last Windsor seas retreated from the area, the Mabou Group (formerly the Canso Group) was deposited. The relationship between the Windsor and the overlying Mabou Group is unconformable to conformable (Utting 1987) and represents a transition from marine to lacustrine and fluvial conditions. Sedimentary rocks of the Mabou Group consist of red and grey siltstones, shales, interbedded sandstones, and thin carbonates. Microfloral (spore) assemblages suggest a Late Viséan to Namurian A age for the Mabou Group (Utting 1987; Neves and Belt 1970).

The Cumberland Group (formerly named the Riversdale) unconformably overlies the Mabou Group. Sedimentary rocks of the unit consist predominantly of medium- to coarse-grained, grey to buff-weathered fluvial sandstones. The Cumberland Group, assigned as Westphalian A to Stephanian age (Giles 1994 pers. comm.), is rich in carbonized plant fossils, coal seams, and intercalated red, black, and grey shales. The Stephanian Pictou Group conformably to disconformably overlies the Cumberland Group. Strata of the Pictou Group consist of red fine-grained clastic

rocks and pebbly sandstones.

1.4 Previous Work on the Mabou Group

The definition of the Mabou Group has evolved through time with the increased understanding of the regional geology, with the newly introduced subsurface data, and with the aid of time correlations using palynology (Fig. 1.1). Initially, Mather and Trask (1929) assigned the term Mabou Formation to dark grey shales and gypsum, overlying Windsor Group sedimentary rocks, exposed throughout the Port Hood and Southwest Mabou River areas. Subsequently, Norman (1935) extended the definition to include fine- to medium-grained red and grey sandstones and shales of suspected Pennsylvanian age in the Lake Ainslie map-area. Within this definition, Norman included the previously defined Mabou Formation as well as other units lying between the Windsor Group and the Port Hood coal measures. Mather and Trask (1929) and Norman (1935) named the Mabou Formation in recognition of the type locality that provides an excellent exposure of Mabou sedimentary rocks along the Southwest Mabou River.

Bell (1944) subsequently assigned the term Canso Group to strata equivalent to the Mabou Formation, based on the vertical distribution of plant species. Still maintaining the age restrictive definition Canso Group, Rostoker (1960) was the first to divide the grey and red fine-grained rocks of the Canso Group within the Western Cape Breton and Antigonish Basins. The units defined by Rostoker (1960) included a lower grey unit, termed the Hastings Formation, and an upper red unit, the Pomquet

		Age	Norman (1935)	Bell (1944)	Belt (1964,65)	This Paper	
CARBONIFEROUS	PENNSYLVANIAN	STEPHANIAN	BROAD COVE FORMATION			PICTOU GROUP	
		WESTPHALIAN	D	INVERNESS FORMATION	PICTOU GROUP	COARSE FLUVIAL FACIES	CUMBERLAND GROUP
			C		CUMBERLAND GROUP		
			B		RIVERSDALE GROUP		
		NAMURIAN	A	PORT HOOD FORMATION		MABOU GROUP	MABOU GROUP
			B	MABOU FORMATION			
	MISSISSIPPIAN	VISEAN			CANSO GROUP		
				WINDSOR SERIES	WINDSOR GROUP	WINDSOR GROUP	WINDSOR GROUP

Figure 1.1. Changes in the definition of the Mabou Group through time.

Formation. Belt (1965) extended the Hastings Formation to include the grey facies of the Canso Group that crop out in eastern Nova Scotia, and the Pomquet to include sections of the upper Canso Group and a small part of the lower Riversdale Group (Fig. 1.2).

In 1964, Belt reestablished the name Mabou for the Canso Group, raising the Mabou Formation to group status while recommending rejection of Canso as a formal group name. His study of the Mabou Group was the first, and remains the most comprehensive analysis of regional stratigraphy and sedimentology of latest Viséan to early Namurian strata in Atlantic Canada.

Within the Sydney Basin, the Mabou Group consists of a grey facies and a red facies, termed the Cape Dauphin and Point Edward Formations, respectively (Bell and Goranson 1938). In the Loch Lomond Basin, the MacKeigan Lake Formation comprises the section of grey and red mudrock, evaporites, and thin carbonates overlying the Windsor Group (Boehner and Prime 1993). This formation is equivalent to the Hastings Formation of the Western Cape Breton Basin, and the Cape Dauphin Formation of the Sydney Basin.

1.5 Scope

Data used for this study originate from six measured stratigraphic sections and two drill cores that provide excellent exposure of the Mabou Group (Fig. 1.3). Areas studied lie within Inverness, Victoria, and Cape Breton Counties of Cape Breton Island, Nova Scotia. The main study area for this project is Inverness County, within

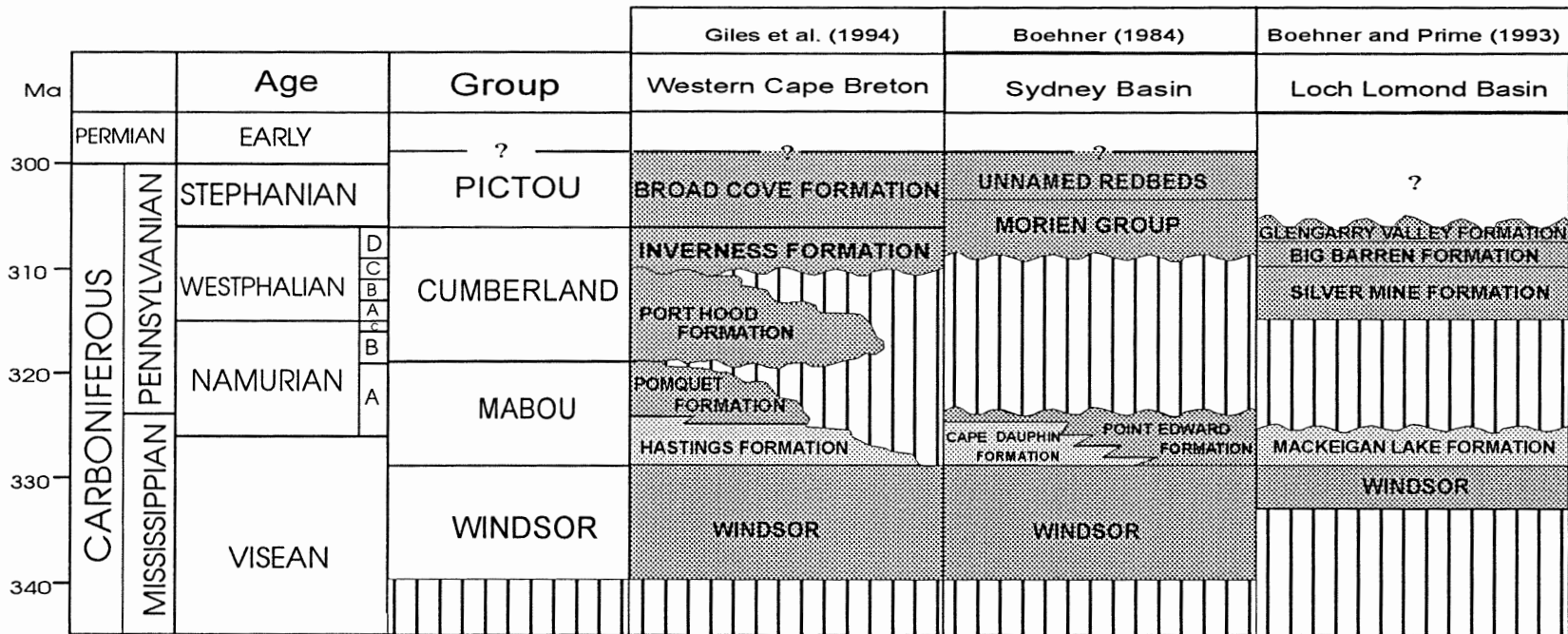

Figure 1.2 An outline of the stratigraphy of the Mabou Group of the areas studied.

the Western Cape Breton Carboniferous Basin. This region includes five stratigraphic sections, namely Ragged Point (Little Judique Harbour), Southwest Mabou River (two sections), Ainslie Point, and Broad Cove Chapel (Fig. 1.3). Sections from Victoria County of the Sydney Basin include Cape Dauphin and NSDME drill hole Woodbine Road 84-1. Amax Exploration drill hole BB74-4, located southeast of MacKeigan Lake in the Loch Lomond Basin, Cape Breton County, was also measured for this study. These sections are best for detailed study because of their excellent exposure and either easy accessibility or excellent recovery in drill core. All measured sections are of the Mabou Group grey facies. This project involves the study of carbonate rocks of the Mabou Group grey facies and their association with related lithofacies, within the limits of field observations and petrographic analysis. Petrographic studies consisted of studying 29 thin sections that aided in the identification of carbonate grain types, textures, and cementation history.

1.6 Organization

Chapter 2 describes the grey facies of the Mabou Group, and discusses its stratigraphic relationship to adjacent rock units. Chapter 3 is a detailed study of the carbonates based on petrographic studies. A description of the lithofacies of the Mabou Group grey unit helps to determine the relationship of the carbonates to associated sedimentary rocks. Chapter 4 gives environmental interpretations based on findings from Chapter 3. Chapter 5 provides a discussion on lacustrine environments as they relate to deposition of the lowermost Mabou Group and summarizes the

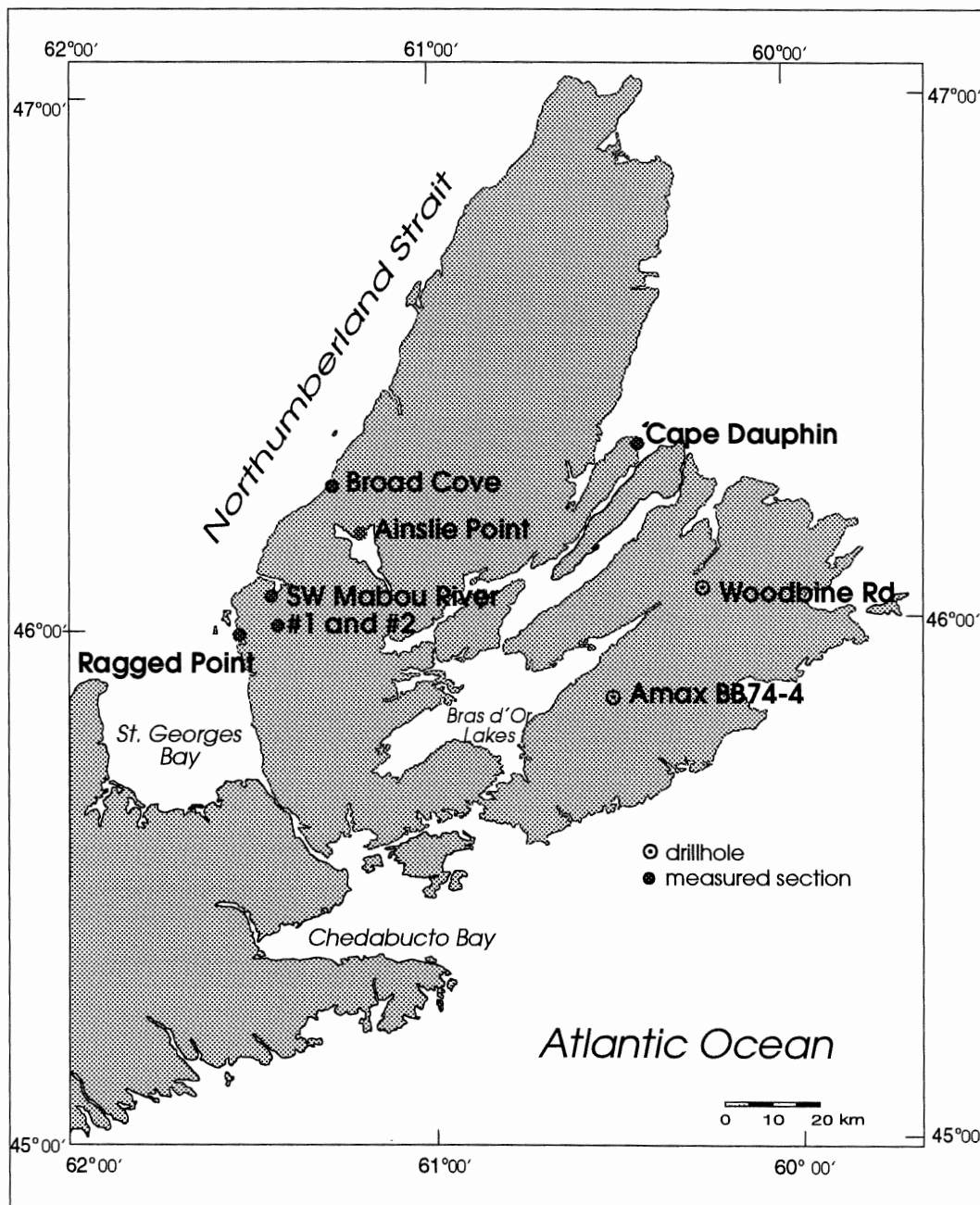

Figure 1.3 Location map of Cape Breton Island, Nova Scotia showing the positions of measured sections and drill holes.

project and interpretations formulated throughout the study. Appendix A contains graphic logs representing each stratigraphic section measured and show the positions of each carbonate rock.

Chapter 2: Mabou Group Stratigraphy

2.1 Introduction

Understanding the stratigraphy of the Mabou Group is essential to the reconstruction of the palaeoenvironments of Cape Breton Island during Middle Carboniferous time. Strata of the Mabou Group throughout Cape Breton represent a transition from lacustrine to fluvial sedimentation, and thus constitute two lithologically different facies. This chapter provides an overview of the stratigraphy of the Mabou Group and descriptions of the different formations within the different regions of Cape Breton Island.

2.2 General Geology

2.2.1 Age

Neves and Belt (1970) identified microfloral assemblages of *Vallatisporites ciliaris*, *Schulzospora elongata*, *Grandispora spinosa*, and *Potoniesporties elegans*. Through comparisons of these assemblages with those of Britain and Northern Spain, Neves and Belt (1970) concluded that the Mabou Group is Late Viséan to Namurian A age. Utting (1987) assigned the lower part of the Mabou Group, near the Windsor contact, to a Late Viséan age based on the dominance of the miospores *Crassispora trychera* within the sedimentary rocks of this group.

2.2.2 Type Section

The type section of the Mabou Group lies along the Southwest Mabou River, between the communities of Port Hood and Southwest Mabou, Inverness County (Mather and Trask 1929; Norman 1935). The type locality provides the best exposed and most complete section of the Mabou Group, although the uppermost section is poorly exposed here and the base is faulted.

2.2.3 Contact Relationships

Observable Windsor-Mabou contacts exist at Broad Cove, Cape Dauphin, Ragged Point, and in drill cores BB74-4 and Woodbine Road. The E1 Limestone (Stacey 1953) in the western Cape Breton Carboniferous Basin marks the top of the Windsor Group on which the Mabou Group conformably lies. The lithologically equivalent limestone in the Sydney Basin is the Dixon Point Limestone and in the Loch Lomond Basin is the Big Glen Member (Boehner and Prime 1993). The Mabou Group lies conformably to unconformably below the fluvatile Cumberland Group.

2.2.4 Regional Extent

Tracing the extent of the Mabou Group across Cape Breton Island is difficult because the rocks generally occur as isolated outcrops or exposures along the coast and river banks. The best exposures of the Mabou Group grey facies occur on the western portion of Cape Breton Island as the Hastings Formation. In the Sydney and Loch Lomond Basins the grey facies is still present, but not as well exposed as in the

Western Cape Breton Basin. The total thickness and abundance of red beds in the Mabou Group decrease from west to east. In the west, the Mabou Group attains a maximum thickness of 7620 metres (Belt 1965), whereas in the east it reaches 76 metres (Boehner and Prime 1993).

2.2.5 Subdivisions

Two distinctive mappable units comprising the Mabou Group occur throughout Cape Breton Island. Lithologically, the lower part consists predominantly of dark grey siltstone and shale, in addition to red and green siltstones, fine-grained sandstones, thin carbonates, and impure gypsum. (Refer to Appendix A for graphic logs of the grey facies). These rocks are non-marine with intercalated brackish water deposits. Evidence for their non-marine and brackish water origins includes the presence of the non-marine arthropods *Teallicaris*, *Lynceites* and *Dithyrocaris* and brackish-water ostracod genera of *Paraparchites* and *Beyrichiopsis* (Copeland 1957). Rocks in the upper Mabou Group consist of reddish-brown sandstone, siltstone, and shale deposited in fresh water as indicated by the presence of the pelecypods of *Leaia baentschiana* and *Leaia acutilirata* (Copeland 1957).

2.3 Grey Facies of the Mabou Group

The Hastings Formation, named after its type section at Port Hastings in the Western Cape Breton Basin, is the lowermost unit of the Mabou Group on the western side of Cape Breton Island. It consists of dark grey shale, grey calcareous siltstone,

grey dolomitic mudstone, grey and red non-calcareous siltstone with interbedded sandstone, gypsum, and thin carbonates. In the Southwest Mabou River and Broad Cove sections, fining-upward cycles consist of (bottom to top): (1) red sandstones, interbedded and transitional with red blocky siltstones; (2) red laminated siltstone; (3) gradational contact into grey-buff laminated siltstones with or without carbonate strata; and (4) grey siltstones with thin interbeds of dolomitic mudstones. These cycles vary in thickness and completeness throughout the sections, with the contacts between these units grading into one another.

The Hastings Formation contains up to 40 percent red fine-grained clastic rocks in contrast with the lithologically equivalent Cape Dauphin and MacKeigan Lake Formations which have lesser amounts of red beds. The total thickness of the Hastings Formation ranges from 425 to 765 metres (Belt 1965).

The Cape Dauphin Formation conformably overlies the Windsor Group in the Sydney Basin. It reaches a maximum thickness of 90 metres at the Cape Dauphin type section (Bell and Goranson 1938). Sedimentary rocks of the Cape Dauphin Formation consist predominantly of grey laminated and blocky siltstones, black coaly shales, thin carbonate rocks, and gypsum near the base. Rock types of the Cape Dauphin Formation correlate with the MacKeigan Lake and Hastings Formations. Although red beds occur within the Hastings and MacKeigan Lake Formations, none exists in the Cape Dauphin section. The Woodbine Road section contains abundant gypsum interbedded with grey siltstones near the Windsor contact. A visible contact of the Mabou with the highest Windsor limestone, the Dixon Point Limestone, occurs

at both the Cape Dauphin and Woodbine Road sections. A regional unconformity beneath the Morien Group truncates the top of the Mabou Group in the Sydney Basin (Fig. 1.2).

The MacKeigan Lake Formation of the Loch Lomond Basin conformably overlies the Big Glen Member of the Windsor Group and, in some localities, lies disconformably on basement rocks (Boehner and Prime 1993). The MacKeigan Lake Formation type section is defined in drill hole BB74-4 (Amax Exploration 1974) (Boehner and Prime 1993). Rocks of the MacKeigan Lake Formation consist of grey laminated siltstones, coaly shales, red siltstones, grey dolomitic mudstones, gypsum, red and grey interbedded fine- to medium-grained sandstones, and carbonate rocks. Total thickness of the MacKeigan Lake Formation grey facies is approximately 80 metres, whereas the red facies reaches a thickness of 30 metres. Rocks in the top unit of the MacKeigan Lake Formation consist predominantly of red fine- to medium-grained sandstones and siltstones, perhaps equivalent to the Pomquet Formation. The Silver Mine Formation of the Cumberland Group disconformably overlies the MacKeigan Lake Formation (Boehner and Prime 1993) (Fig. 1.2).

2.4 Red Facies of the Mabou Group

The Pomquet Formation conformably overlies the Hastings Formation of the Mabou Group within the Western Cape Breton and Antigonish Basins (Belt 1965). Typical of the red facies, the Pomquet Formation consists predominantly of red sandstone, siltstone, and shale with lesser amounts of green and grey equivalents. The

sandstones contain ripple marks, horizontal laminations, and small scale cross-bedding. Some exhibit a calcareous matrix and calcrete nodules. The total thickness of the Pomquet Formation at its type section along the Pomquet River in the Antigonish Basin is approximately 5490 metres (Belt 1965).

The Point Edward Formation in the Sydney Basin conformably overlies the Cape Dauphin Formation and is lithologically equivalent to the Pomquet Formation (Fig. 1.2). Rocks of the Point Edward Formation consist dominantly of red, and occasionally mottled green, siltstones with interbedded sandstones and conglomerates. Sandstones contain calcrete nodules and exhibit cross lamination. The formation reaches a total thickness of 213 metres and unconformably underlies the Morien Group (Giles 1983).

2.5 Summary

The Mabou Group consists of a red and grey unit in all measured sections except the Cape Dauphin type section, where it is entirely grey. The grey facies, dominated by fine-grained grey clastic rocks, contains most of the carbonate rocks of the Mabou Group. The next chapter discusses the types of carbonate rocks of the lowermost Mabou Group and their related lithofacies.

Chapter 3: Carbonate Rocks and Associated Lithofacies

3.1 Introduction

Carbonate rocks of the Mabou Group and their associated lithofacies act as important paleoenvironmental indicators. A diverse range of carbonate rocks exists within the Mabou Group requiring a classification scheme to categorize them, thereby aiding in the reconstruction of conditions prevailing during deposition. This chapter presents the classification scheme used in this study, and provides descriptions of the carbonate rocks and their associated lithofacies.

3.2 Classification

To categorize carbonate rocks of the Mabou Group, this study uses the classification of Embry and Klovan (1971) based on depositional textures (Table 3.1). This classification scheme, a modification of the classification of Dunham (1962), concentrates on three textural features: (1) presence or absence of carbonate mud; (2) abundance of grains; and (3) signs of binding during deposition. Dunham (1962) divided carbonate rocks into six groups based on depositional texture, but Embry and Klovan (1971) found that Dunham did not adequately categorize organically laminated boundstones. Thus, Embry and Klovan (1971) expanded the classification of Dunham (1962), placing more emphasis on coarse-grained carbonates with components > 2 mm. They subdivided the so-called boundstones on the nature of organic binding into

framestones, bindstones, and bafflestones. Furthermore, components such as grain or constituent type help to classify the carbonates into specific types (e.g., an oolitic grainstone is a grainstone containing an abundance of ooids).

ALLOCHTHONOUS LIMESTONE ORIGINAL COMPONENTS NOT ORGANICALLY BOUND DURING DEPOSITION						AUTOCHTHONOUS LIMESTONE ORIGINAL COMPONENTS ORGANICALLY BOUND DURING DEPOSITION		
LESS THAN 10% > 2MM COMPONENTS				GREATER THAN 10% >2MM COMPONENTS		BY ORGANSIMS WHICH BUILD A RIGID FRAMEWORK	BY ORGANSIMS WHICH ENCRUST AND BIND	BY ORGANSIMS WHICH ACT AS BAFFLES
CONTAINS LIME MUD (<.03 MM)			NO LIME MUD			MATRIX SUPPORTED	> 2MM COMPONENT SUPPORTED	BOUNDSTONE
MUD SUPPORTED		GRAIN SUPPORTED						
LESS THAN 10% GRAINS (>.03MM <2MM)	GREATER THAN 10% GRAINS							
MUD- STONE	WACKE- STONE	PACK- STONE	GRAIN- STONE	FLOAT- STONE	RUD- STONE	FRAME- STONE	BIND- STONE	BAFFLE- STONE

Table 3.1 Classification of carbonate rocks based on depositional texture (Embry and Klovan 1971).

3.3 Carbonate Rocks

Based largely on the classification of Embry and Klovan (1971), the types of carbonate rocks within the grey facies include: (1) stromatolitic bindstones; (2) intraclastic floatstones, grainstones, and packstones; (3) oolitic packstones to grainstones; (4) peloidal grainstones; and (5) serpulid wackestones. The following sections describe each of these carbonate rock types in detail.

3.3.1 Stromatolites

Stromatolites are organo-sedimentary structures produced by sediment trapping, binding, and/or precipitation as a result of growth and metabolic activity of microorganisms, principally cyanophytes (blue-green algae) (Walter 1976).

Stromatolitic bindstones, the most common and obvious form of carbonate rock within the Mabou Group, comprise up to 60 per cent of all carbonate strata. They range in size and shape reaching a maximum height of 60 cm. Common forms of stromatolite in the Mabou Group are laterally-linked hemispheroids (Fig. 3.1) and stratiform or flat-lying types (Fig. 3.2). Other bindstones consist of more complex forms containing a variety of laminae configurations (Fig. 3.3). The stromatolites generally lie on top of grey siltstones or grey and buff laminated siltstones, and also underlie these rock types.

Contacts of stromatolites with underlying sediments are abrupt. Lithologies change from dark grey fine-grained clastics to micritic carbonate material that makes up the bulk of stromatolites. Stromatolites may drape over previously eroded beds (Fig. 3.4), whereas others have a planar contact with underlying sediments. In outcrop, stromatolites range from individual colonies to laterally continuous forms.

Stromatolites consist of well-developed laminae that occur as multiple couplets. The production of laminae results from two interacting processes, namely sedimentation and cyanobacterial growth. Lightly coloured laminae are sediment-rich and consist predominantly of carbonate mineralogy; dark coloured laminae are organic-rich and consist mainly of cyanobacteria (Park 1976). Laminae in samples from the



Figure 3.1 Laterally-linked hemispheroid stromatolite, overlying dark grey shale of the Hastings Formation, Ainslie Point. The stromatolite is laterally discontinuous in outcrop.



Figure 3.2 Stratiform stromatolite overlying dark grey finely laminated shale of the Cape Dauphin Formation, Cape Dauphin. Laminae within the stromatolite are asymmetrically convex up and gradually flatten out towards the top. Maximum thickness of the stromatolite is 12 cm.



Figure 3.3 Compound stromatolite containing an intraformational conglomerate at the base. Laminae range from discontinuous and overturned in the middle part of the stromatolite to continuous and corrugated on the top surface. This stromatolite is from the Hastings Formation, Ainslie Point.

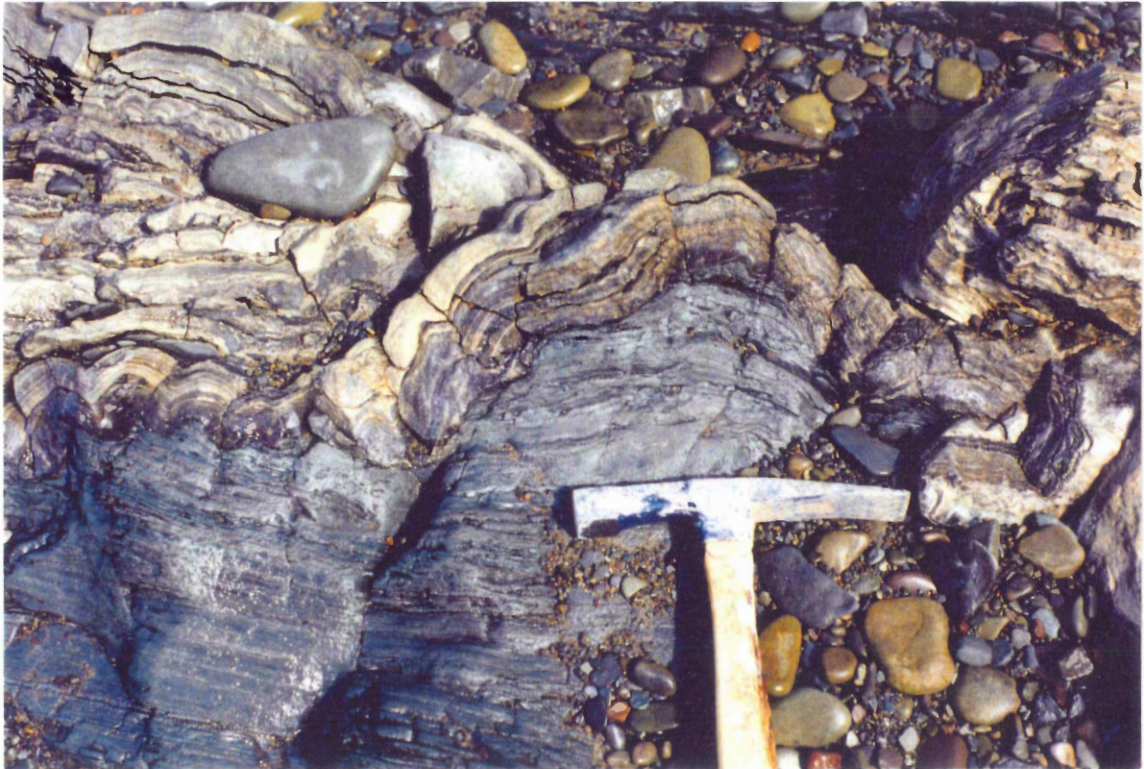

Figure 3.4 Stromatolite developed on top of previously eroded laminated grey siltstones from the Hastings Formation, Broad Cove Chapel.

Mabou Group consist generally of alternating dark grey and buff layers that range from 0.2 to 1 mm in thickness. Commonly, one lamina type is thicker than the other in each couplet within the stromatolite. Good second- and third-order corrugate laminae are evident in samples obtained from Southwest Mabou River and Broad Cove.

Internal texture of the stromatolites is generally patchy micrite, ranging from brown to green in colour under plane-polarized light. Some samples exhibit well-developed radially fibrous calcite structures (< 0.5 mm) separated by thin micrite bands. In others, laminae are less developed or not as well preserved; thus, the internal structure of the stromatolites appears as dense micrite. In samples where poorly developed laminae exist, a fenestral texture may occur with pore spaces infilled with spar calcite. Peloids, ooids, and quartz grains are scattered within the stromatolite laminae, and commonly oriented with their long axes parallel to laminations in associated stromatolites. These grains commonly have a radially fibrous rim, thinner than the actual fibrous stromatolite laminae.

3.3.2 Intraclasts

Intraclasts are fragments of penecontemporaneous, generally weakly consolidated, carbonate sediment eroded from adjoining parts of the substrate and redeposited to form a new sediment (Folk 1962). The intraclasts may derive from underlying algal mats or carbonate muds.

Packstones and floatstones containing intraclasts as the dominant grain type commonly occur with stromatolitic bindstones. The intraclasts (Fig. 3.5) range from



Figure 3.5 Intraclastic or flat-pebble conglomerate. The flat pebbles are derived from algal mats and desiccation mud chips of neighbouring rocks. Interstitial material shows small, sand- and silt-size lithic grains. Sample is from the Cape Dauphin Formation, Woodbine Road drill core (scale bar = 2 cm).

0.1 to 50 mm in length, are buff to grey in colour, finely laminated and mimic pieces of stromatolites in terms of laminations, colour, and general appearance. Intraclasts and associated grains occur either as well sorted and aligned parallel to bedding, or poorly sorted with no preferred orientation (Fig. 3.5).

In thin section, intraclasts are micritic, porous, generally elongate fragments. Those derived from algal mats exhibit mm-scale laminations and/or a fenestral texture, whereas those of carbonate mud are structureless. In some samples, layers of fine-grained calcite alternating with micritic laminae occur within the algal fragments. Laminations in the intraclasts may be planar and parallel to wavy. The matrix between intraclasts varies from predominantly pore-filling spar calcite cement, as in the grainstones (Fig. 3.6), to silt-size quartz and feldspar grains enclosed within calcareous micrite (Fig. 3.7). Ooids and peloids associated with the intraclasts comprise less than five percent of all grains within the intraclastic carbonate rocks.

Thin sections of carbonate rocks from Ainslie Point contain long narrow fragments derived from algal material (Figs. 3.6 and 3.7). Clasts range from well rounded and well sorted to jagged and poorly sorted.

3.3.3 Ooids

The dominant constituents within oolitic carbonates are small, rounded to ovate accretionary bodies, that have successive concentric layers formed around a nucleus

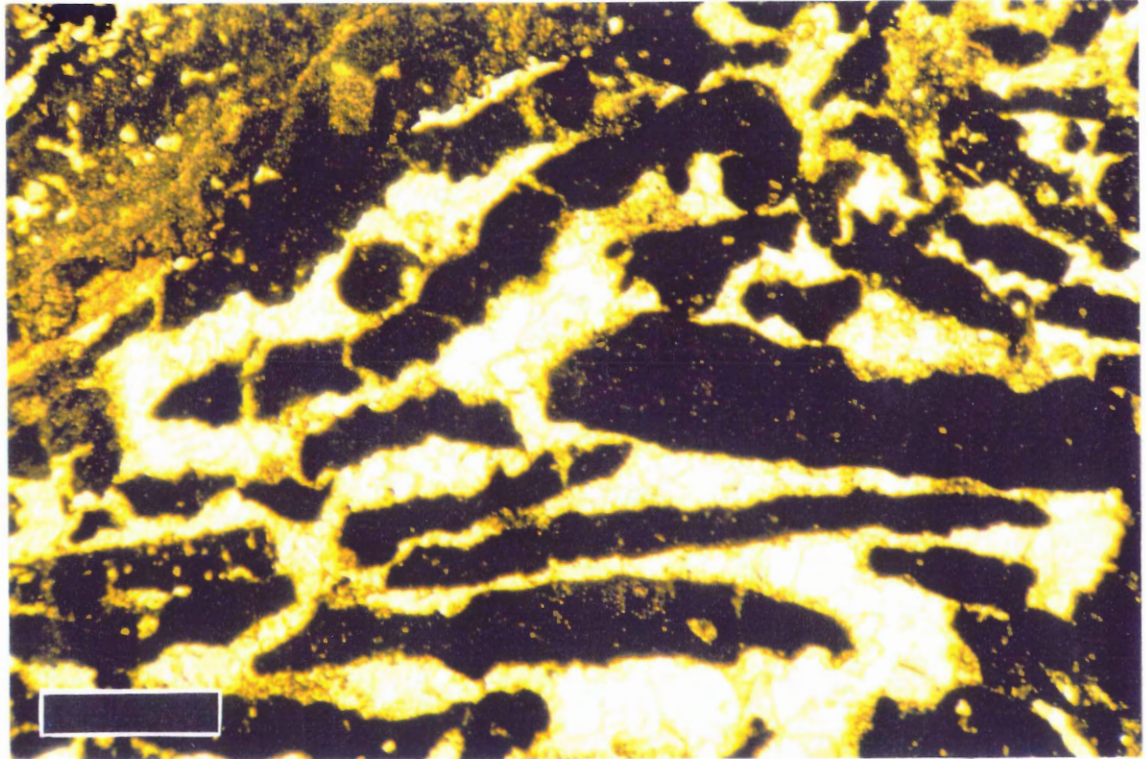

Figure 3.6 Intraclastic grainstone in thin section. The intraclasts appear to be fragments derived from the algal mat in the upper left-hand corner. This sample comes from the Hastings Formation, Ainslie Point (scale bar = 0.5 mm).

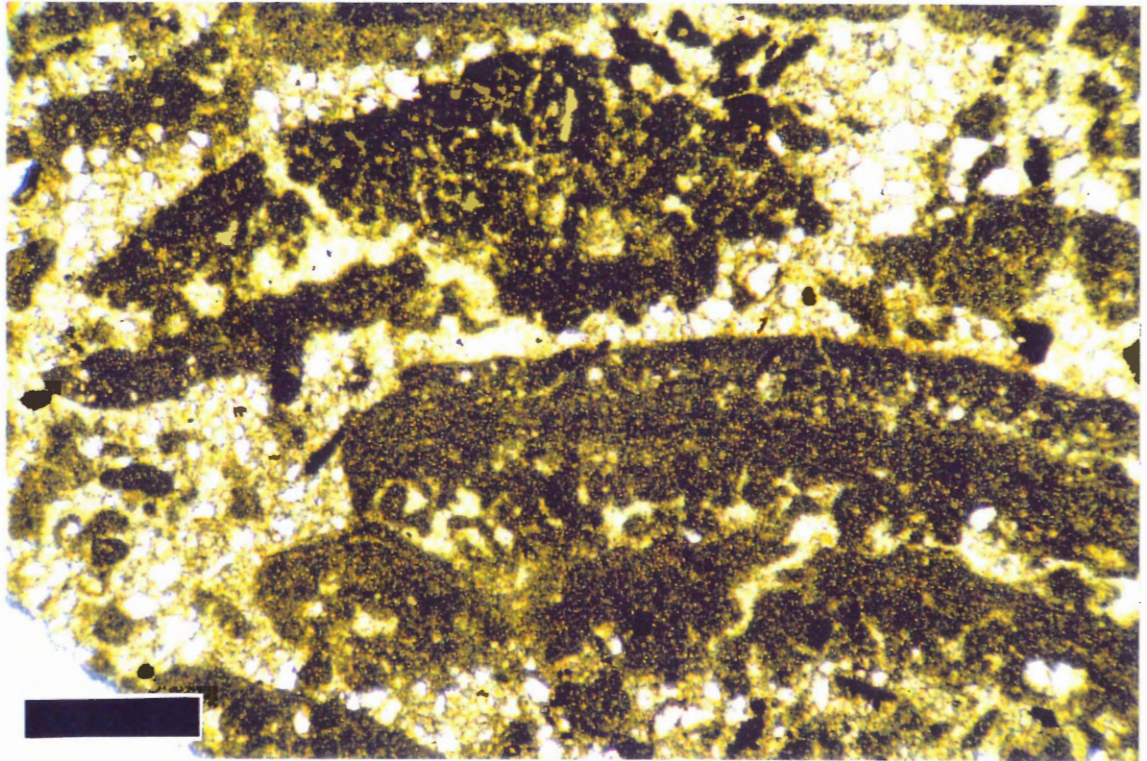

Figure 3.7 Intraclastic packstone in thin section. Intraclasts are porous fragments derived from algal mats or stromatolites. The sediment between the intraclasts is muddy with abundant silt-size quartz grains. This sample comes from the Hastings Formation, Southwest Mabou River (scale bar = 0.5 mm).

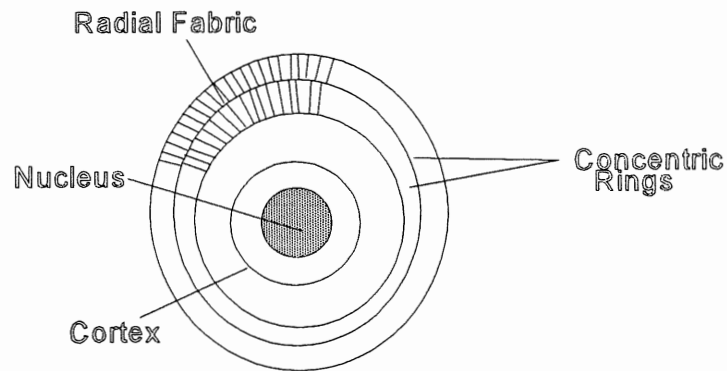

Figure 3.8 The structure of an ooid.

(Fig 3.8). External ooid shape may represent the shape of the grain around which the ooid nucleated, notably in cases where only a few thin fibrous oolitic coatings are present. Ooids within the Mabou Group grey facies display a great variety of forms as discussed below.

Oolitic grainstones occur as several thin beds within the Hastings Formation at Ainslie Point, Broad Cove, and Southwest Mabou River. A massive, parallel laminated, oolitic grainstone reaching a maximum thickness of one metre occurs at Ainslie Point, North Lake Ainslie. Abundant algal fragments occur within the lowermost 17 cm of this oolite, whereas the uppermost 24 cm consists dominantly of serpulid fragments. The middle part of the grainstone consists mainly of ooids closely packed within a pore-filling sparry calcite. In parts of the rock, a micritic matrix between the ooids contains scattered silt- and sand-size quartz grains. Individual ooids

possess well-developed concentric and radially fibrous structures. In approximately 30 percent of the ooids, sparry calcite cement replaces the inner cortex (Fig. 3.9). Some ooids possess a nucleus of either micrite or quartz grains, whereas in others the original nucleus is not evident. The ooids range from 0.5 to 1 mm in diameter. Thin sections from the middle part of the Ainslie Point oolite show ooids that are closely packed, resulting in asymmetric forms and pressure-solution at the contacts of some ooids. Within the uppermost 24 cm of this oolite, ostracod fragments act as nuclei for ooid formation. The ooids in this part of the rock are larger, ranging in size from 0.5 to 3.5 mm diameter. Generally one thick radial coat develops around individual or clusters of ostracod fragments (Fig. 3.10). The inner part of the ostracod contains a thin coat of micrite and is subsequently infilled by patches of pore-filling sparry calcite. The part of the rock consisting predominantly of these ooids is poorly sorted with scattered detrital material in the matrix.

A cross-bedded, 24 cm thick, oolitic grainstone from the Southwest Mabou River, contains well-rounded spherical to elliptical ooids. The ooids have well-developed radial and concentric fabrics and contain cores of quartz and/or micrite. They range in diameter from 0.5 to 1 mm. Void-filling spar calcite envelops loosely packed and well-sorted ooids. Calcite crystals decrease in number and increase in size toward the pore space. In another part of the same rock, the ooids are less abundant and are enclosed in a micritic cement that also contains serpulid fragments. A remnant meniscus film coats some ooids in parts of this rock (Fig. 3.11).

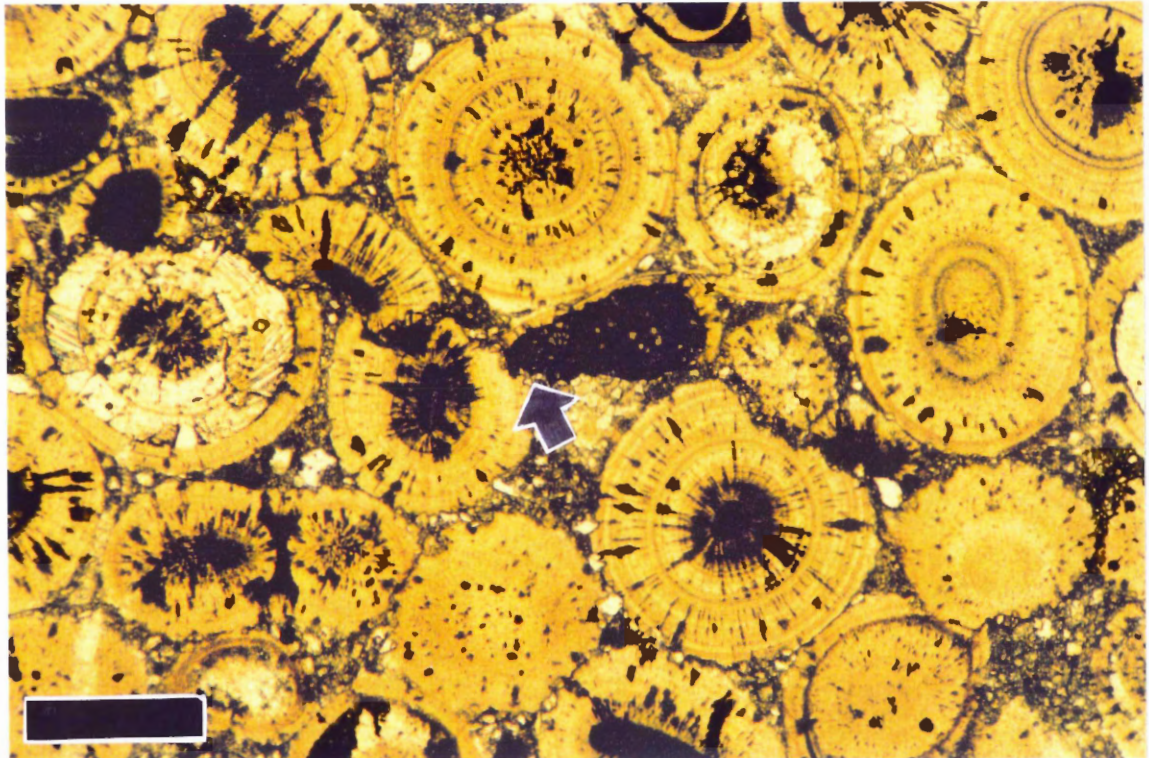

Figure 3.9 Oolitic packstone from the Hastings Formation, Ainslie Point. Ooids show well-developed radial and concentric structures and nuclei consisting of micritic grains. The ooids are well-sorted within a muddy matrix containing abundant silt- and sand-size quartz grains. Note stylolite through the centre of the photo and replacement of the cortexes of some of the ooids by spar calcite (scale bar = 0.5 mm).

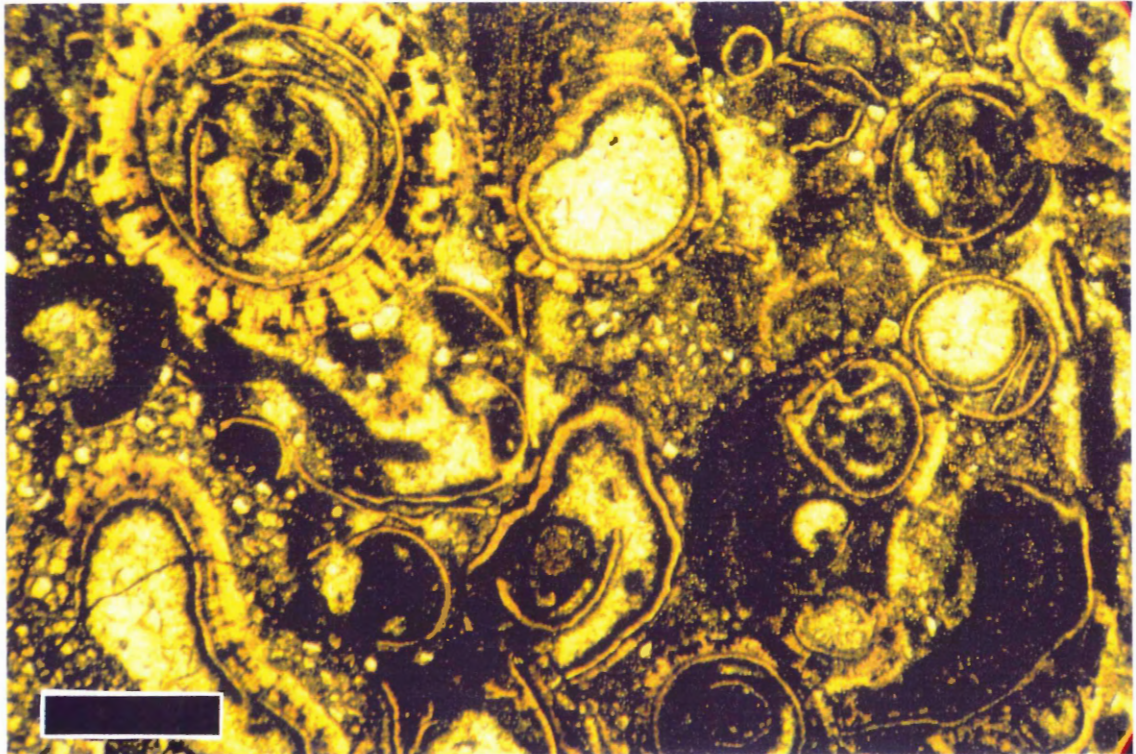

Figure 3.10 Oolitic packstone from the Hastings Formation, Ainslie Point. The ooid nuclei consist of ostracod fragments infilled with spar cement, but not all the ostracods have an oolitic coating. Ooids occur within a poorly sorted muddy matrix containing quartz grains (scale bar = 0.5 mm).



Figure 3.11 Oolitic grainstone from the Hastings Formation, Southwest Mabou River. Note the micritic meniscus cement formed around the ooids. Spar calcite fills the rest of the pore space (scale bar = 0.5 mm).

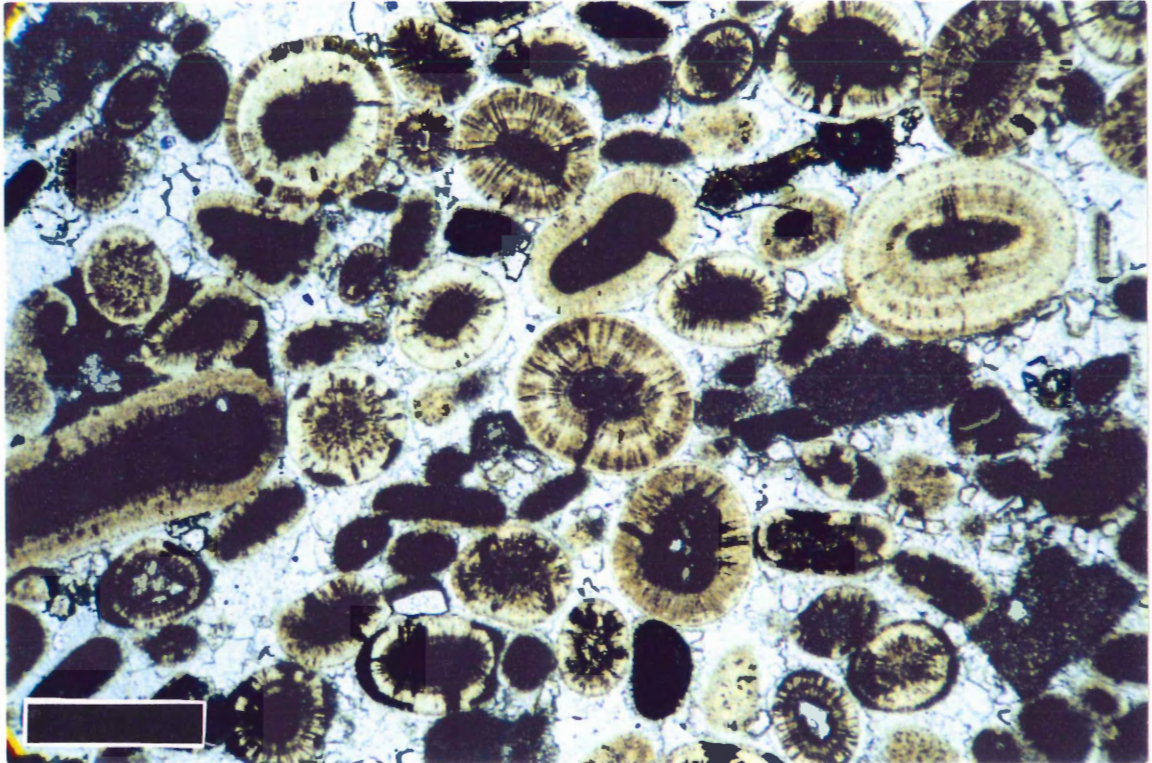

Figure 3.12 Oolitic grainstone from the Hastings Formation, Broad Cove Chapel. The ooids are spherical to elliptical exhibiting well-developed radial and concentric structures with nuclei ranging from micritic carbonate to quartz grains. Ooids and a small number of intraclasts are poorly sorted within pore-filling spar cement (scale bar = 0.5 mm).

Ooids from Broad Cove Chapel contain radial to concentric structures around a nucleus of micrite and/or quartz grains. Figure 3.12 shows the loosely packed, well-rounded, spherical to elliptical ooids. The nucleus in some ooids comprises up to 50 per cent of the total ooid. The ooids range from 0.2 to 1 mm in diameter. A spar calcite cement infills the pore spaces existing between the loosely packed ooids and minor intraclasts and peloids.

3.3.4 Peloids

Peloids occurring at the Southwest Mabou River section are well rounded, spherical to elliptical in shape, and appear to have undergone compaction, evident by a spastolithic texture (Fig. 3.13). A spastolithic texture results from the compression of ooids or pellets during compaction, suggesting that they were soft for some time after deposition. Sparry calcite cement fills the spaces between peloids in most of the rock, although micritic cement occurs in some parts. The term superficial ooids describes the several peloid-like grains possessing a thin radially fibrous rim of calcite within a sparry calcite cement.

Peloids occur within a grainstone immediately overlying a stromatolite bed in a sample stratigraphically high in the Broad Cove section. In contrast with the superficial ooids, these possess a single thin (0.02 mm) radially fibrous rim that may represent diagenetic rather than accretionary formation (Fig. 3.14). These peloids are rod-shaped, well-rounded, and structureless, ranging in length from 0.5 to 2 mm. A strong preferred orientation parallel to laminations in a neighbouring stromatolitic bindstone

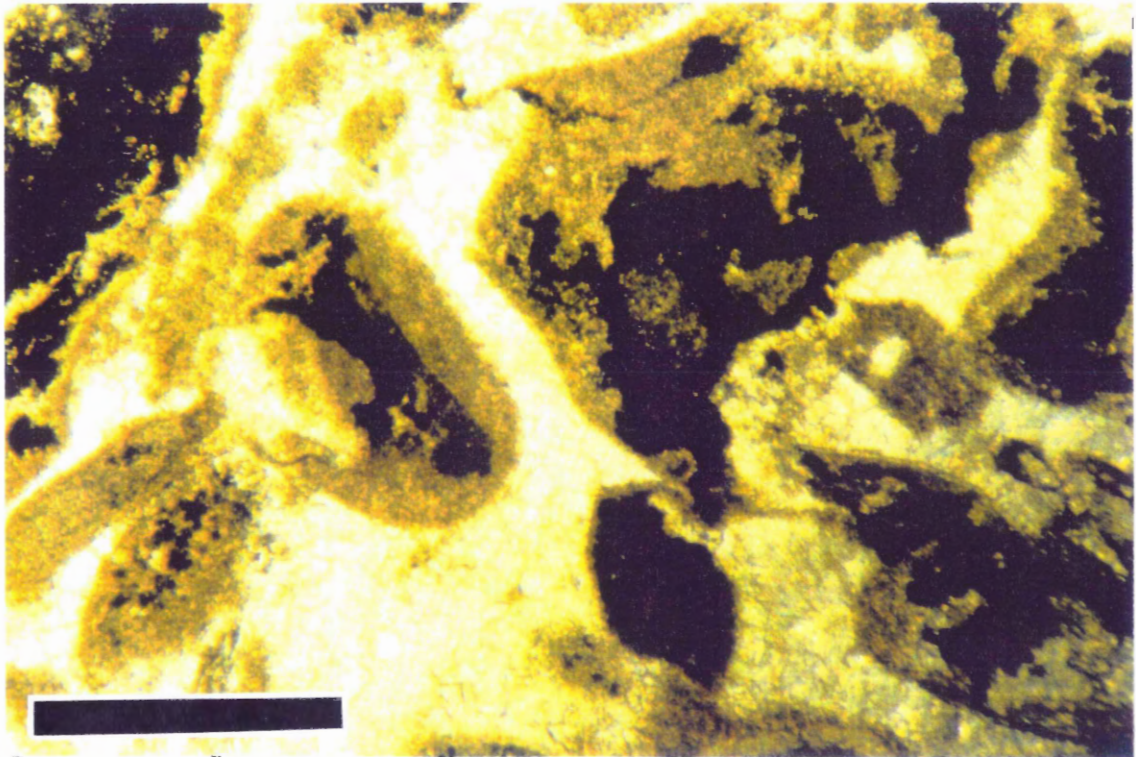

Figure 3.13 Peloidal grainstone from the Hastings Formation, Southwest Mabou River. Micritic peloids of variable colour within spar cement. Note compaction of the peloids evident from the spastolithic texture (scale bar = 0.25 mm).

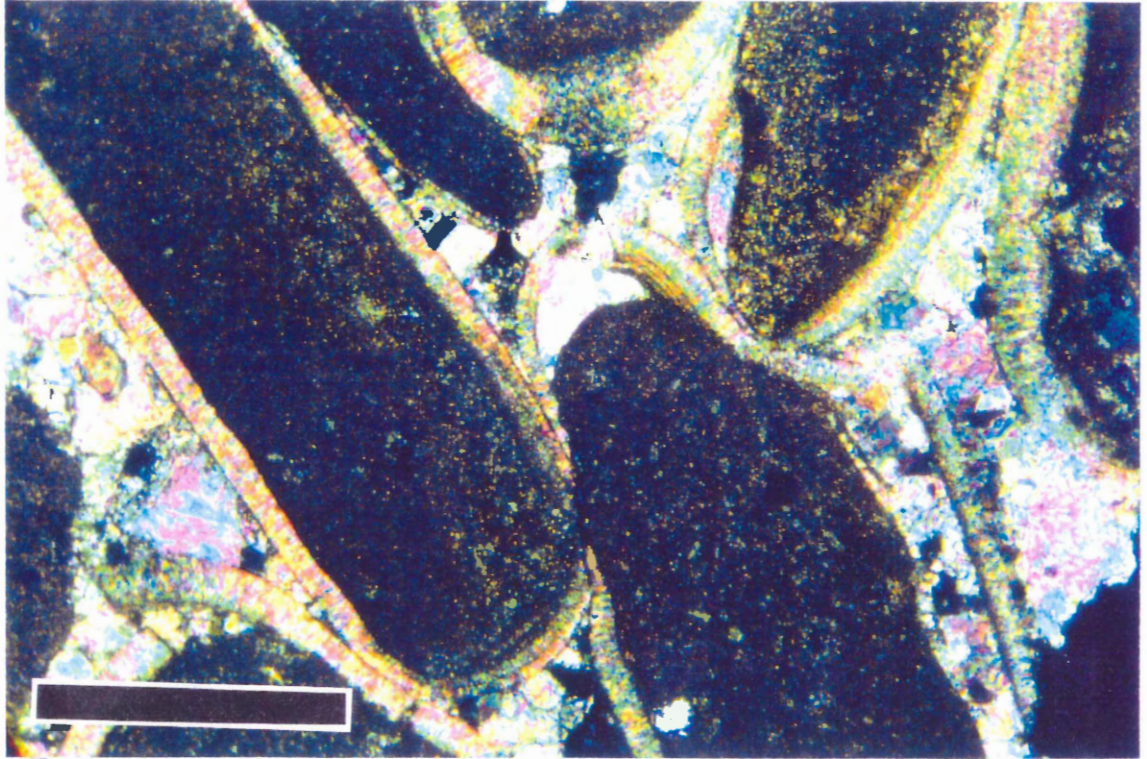

Figure 3.14 Peloidal grainstone from the Hastings Formation, Broad Cove Chapel. Well-rounded flat pebbles which have a radially fibrous calcite rim, ranging from 0.5 to 2 mm long. They are well sorted and imbricated within a sparry to micritic cement. The presence of buckled rims suggests compaction of the peloids (scale bar = 0.25 mm).

Buckled rims and indented edges of these peloids suggest tight packing and compaction, after the development of the calcitic coat. Calcite cement subsequently filled spaces produced when rims buckled and peeled away from the peloid (or the growth of calcite caused the rims to buckle). The matrix surrounding the peloids consists dominantly of pore-filling spar calcite cement, although micrite containing quartz grains occurs in some parts. The peloids also exist within the laminae of the underlying stromatolitic bindstone. Similar peloids that occur in the adjacent bindstone still have a thin calcite coat but are smaller in dimension, ranging from 0.2 to 0.6 mm in length.

3.3.5 Serpulids

Well-preserved serpulid fragments occur stratigraphically high in the grey facies of the Ragged Point section in thin carbonate beds close to the red facies of the Mabou Group. The beds in which the serpulids occur generally range from 3 to 8 cm thick and are present as discontinuous lenses within grey, silty shales. Tightly coiled serpulid tubes occur at Broad Cove, Ainslie Point, and Ragged Point (Fig. 3.15). The outsides of the tubes have concentric ridges, giving them a ribbed appearance. Serpulid fragments generally occur in close association with ooids and superficial ooids.

Serpulids are sessile organisms that excrete planispirally coiled calcareous tubes, meaning that the mid-line of the curved tubular shell lies entirely in a single plane. The serpulids initially attach their tubes to a firm substrate resulting in the attached side being flattened in the early stages of growth (Burchette and Riding 1977). After the

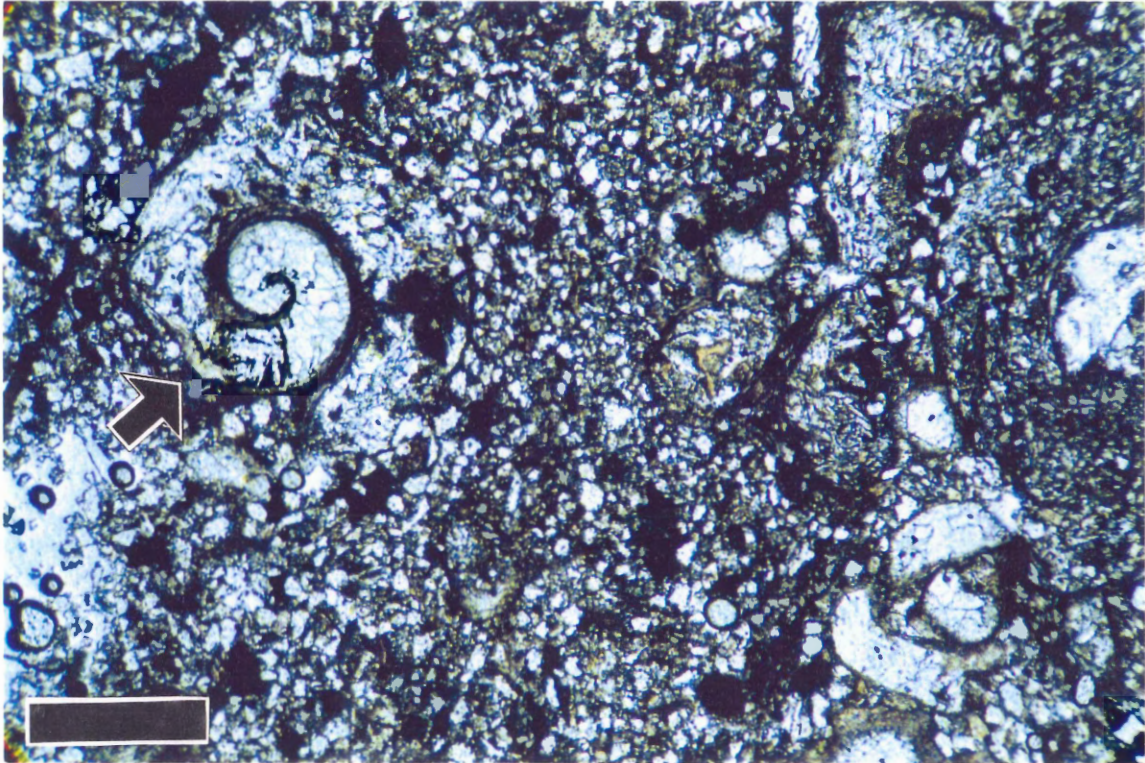

Figure 3.15. Serpulid wackestone from the Hastings Formation, Ragged Point. Well-preserved coiled serpulid tubes enclosed in a siliclastic matrix with abundant silt-size quartz grains (scale bar = 0.5 mm).

development of two or three whorls, the serpulids no longer develop as an encrusting form, but grow helically upwards normal to the substratum. Features such as shell structure, septa, habitat, and helical mode of growth, suggest that serpulids have a close affinity to vermiform 'gastropods' (Weedon 1990; Burchette and Riding 1977). In thin section, basally flattened tubes, formed during early growth stages, distinguish coiled serpulid tubes from the rounded shells of gastropods.

Internal structure of the serpulid tubes consists of tiny parallel wavy laminae. The serpulid tubes exhibit a thin coating of micrite along the inner and outer edges. Pore-filling sparry calcite cement, feldspar, or calcareous micrite rich in silt- and sand-size quartz grains, may fill the innermost part of the serpulid chambers. The matrix around the tubes ranges from a calcareous micrite with abundant quartz grains to a spar calcite.

3.4 Associated Lithofacies of the Grey Facies

3.4.1 Siltstone

Siltstones comprise the dominant lithology of the grey facies. Their colours range from grey to green to red, with grey being prevalent. The siltstones may be laminated and well-bedded, or non-stratified and exhibit blocky weathering with conchoidal fracture.

The most distinctive rock type within the grey facies is a dark grey, finely laminated siltstone. Millimetre-scale laminae occur as couplets of dark grey organic-

rich shale alternating with light grey calcareous siltstone. The light grey laminae weather buff to yellow in colour and have a calcareous cement, and laminae are parallel or wavy to lenticular. This siltstone displays a fissile to platy weathering, is well stratified, and thinly bedded. Associated dark grey and black bituminous shales occur within the grey facies, notably in drill core. Desiccation mud cracks, thin pyrite laminations (< 1-2 mm), and ripple marks also occur in the siltstones.

Interbeds of dolomitic mudstones, associated with the laminated siltstones, range from 2 to 20 cm in thickness. They weather to a buff colour and occur as resistant ledges within more easily eroded siltstones. The mudstones are continuous or laterally discontinuous lenses in outcrop, have a conchoidal fracture, and are commonly finely banded and light to medium grey in colour.

Less commonly, siltstones in the grey facies may be green to red to purplish-red in colour, exhibit blocky weathering, and have slickensides on the fractured surfaces.. Swaley features separate them from regular blocky siltstone (Fig. 3.16). These particular siltstones, interpreted as vertisols, result from expanding, contracting, and churning of clay-rich soils subjected to pronounced changes in moisture content (Graham and Southard 1983).

3.4.2 Sandstone

Sandstones consist of well-sorted quartz-rich sands generally interstratified with siltstones. The sandstones are thinly bedded with beds ranging from 2 to 135 cm in thickness, and average 30-70 cm thick. Shaley partings commonly separate individual



Figure 3.16 Swaley features within blocky siltstones that represent alternating periods of drying and wetting. Sample comes from the Hastings Formation, Broad Cove Chapel.

sandstone beds. Characteristic features of the sandstones are calcareous cements, minor plant debris, pelecypods, cross laminations, calcareous grains (< 1 cm), and halite pseudomorphs. Pebbly sandstones, at the base of fining-upward cycles, only occur within the MacKeigan Lake Formation. Fining-upward sequences in the red sandstones consist of a massive medium- to coarse-grained sand at the base containing red intraclastic mud chips, fining-up to fine-grained sandstone characterized by climbing ripples, and eventually topped by red and grey siltstone. The grey siltstone beds may contain carbonates, notably stromatolites.

3.4.3 Gypsum

Gypsum interbedded with red and grey siltstones occurs only at or near the base of the grey facies at Ragged Point, Broad Cove, Southwest Mabou River, Woodbine Road, and MacKeigan Lake. The gypsum, better preserved in the drill cores than in surface exposures, ranges from white satin spar veins to dark grey and brown parallel-bedded gypsum, with bladed selenite crystals and rosettes. Minor anhydrite occurs at the base of the drill core from Woodbine Road, immediately overlying the Dixon Point Limestone of the uppermost Windsor Group. Satin spar veins crosscut and lie parallel to bedding surfaces, most commonly cutting siltstone and shale interbedded with more massive gypsum beds. Generally where the gypsum beds reach thicknesses of 50 cm or more, they affect neighbouring siltstone beds causing local deformation in the form of folding.

3.5 Summary

Deposits of the lowermost Mabou Group consist of fine-grained clastic rocks with thin carbonate rocks scattered throughout. A variety of carbonate rocks occur within the Mabou Group, each rock providing clues to its depositional environment. The following chapter provides a discusses of implications of these various carbonates.

Chapter 4: Environmental Interpretations

4.1 Introduction

Each carbonate rock within the Mabou Group has implications for its depositional history. Using evidence provided by the carbonate rocks and related sedimentary structures, this chapter discusses probable conditions that existed during the deposition of the lowermost Mabou Group.

4.2 Carbonate Rocks

Carbonate sediments of lacustrine environments may form through (Jones and Bowser 1978) direct precipitation by biological and biochemical processes, by inorganic precipitation, or reworking of lacustrine carbonates exposed during low lake levels. Biological processes that contribute to the formation of carbonate rocks (e.g. stromatolites) occur mainly within shallow waters. These biogenic processes include calcification of stromatolitic algal filaments (Riding 1991), the secretion of calcareous hard parts by certain organisms (e.g., serpulids), and biogenic carbonate derived from skeletal remain. Carbonate mud, or micrite, may form through either biochemical processes related to algal photosynthesis or by inorganic precipitation (Carozzi 1993). Disintegration of shallow-water calcareous green algae may contribute to the formation of carbonate muds (Neumann and Land 1975). Carbonate material may wash in from neighbouring rock units, such as the underlying Windsor Group that contains various carbonate beds.

The following reaction controls the inorganic precipitation of calcium carbonate (CaCO_3) (Leeder 1982):

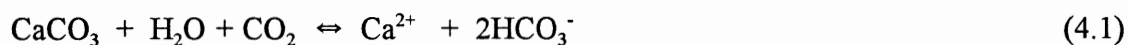

A decrease in the amount of H_2O or CO_2 available to the solution will precipitate calcite. Conditions that can remove carbon dioxide include increasing water temperatures, decreasing pressure, evaporation, agitation, or organic photosynthetic activity of algae and other photosynthetic organisms that occupy the lake. During photosynthesis, the partial pressure of CO_2 decreases in the sediment pore space causing an increase in pH, thereby resulting in precipitation of calcite. Supersaturated freshwater readily precipitates calcium carbonate because this type of water is not buffered (Golubic 1991). Inorganic carbonates (oolites) precipitate in shallow waters (< 10 m), because of a rise in temperature or wave agitation (Platt and Wright 1991).

4.2.1 Stromatolites

The growth of microorganisms that contribute to stromatolite development requires certain prerequisites (Hofmann 1973), including: (1) an open system containing water to act as a growth medium; (2) the presence of a suitable substrate; (3) an energy source such as sunlight; (4) a population of algae or other benthonic microorganisms to colonize the substrate; and (5) a process of lithification and burial allowing for their preservation. In addition, stromatolite growth must exceed the rate of consumption by grazing organisms and the rate of destruction by erosional processes, and by other mechanical and chemical forces (Walter 1976).

Stromatolite development requires exposure to light for the metabolic activities of photosynthetic microorganisms that comprise algal layers within the stromatolite. For stromatolites to obtain the light they need to grow, they form in shallow marine environments or within the intertidal to supratidal zones of shallow lakes (Hofmann 1973).

Trapping and binding, as well as chemical action of non-skeletal algae, contribute to the development of stromatolites in shallow-water environments (Hofmann 1973).

Stromatolites, growing in shallow waters, experience periodic storm activity that supplies influxes of various detrital particles including ooids, peloids or fine-grained quartz and feldspar to the stromatolite surface (Walter 1976). Stromatolites may trap these particles by adhering them to the sticky mucilage produced by microbes (Riding 1991), or by the action of calcified algal filaments that bind and cement the particles to the stromatolite surface (Dravis 1983). Riding (1991) determined that the size of the particles trapped by stromatolites depends on: (1) size and abundance of the particles introduced by currents; (2) strength and frequency of the currents; and (3) stickiness of the surface. The larger particles supplied to the stromatolite orient themselves with their long axis parallel to the growth surface of the mat, and become bound in that position by overlying filaments (Monty 1976).

Stromatolites of the Mabou Group commonly developed on grey to greyish-green laminated siltstones showing ripple marks or desiccation mud cracks. Sedimentary structures associated with stromatolites suggest that they formed in relatively shallow waters, where subaerial exposure was common. Shallow waters may result from evaporation of the lake or proximity of the shore (Surdam and Wolfbauer 1975).

Stromatolites generally do not occur in deeper waters of offshore environments where suspended material in the water column reduces the amount of light.

Stromatolite bases are normally in sharp contact with the underlying sediments, suggesting a change in depositional conditions. The mode of deposition changed from an input of dominantly fine-grained siliciclastics to very fine-grained sediments trapped by the algae within the stromatolites. Changes in sedimentation may result from periods of erosion associated with decreases in water levels or changes in the chemistry of the lake. Some stromatolites have developed on top of flat-pebble conglomerates, suggesting that they established themselves on mudflats soon after flooding (Eugster and Hardie 1975). The same grey finely laminated siltstones generally overlie the stromatolites suggesting that water levels in the lake rose. Associated with a rise in water levels is an increased influx of terrigenous sediments causing stromatolite growth to stop, as their growth rate must equal or exceed rates of clastic sedimentation (Link et al. 1978).

Changes from terrigenous to carbonate deposition may correlate with a change of chemical composition of lake waters, thereby allowing calcium carbonate to precipitate. The lake probably became shallower, and increasing temperatures caused the calcium carbonate content to increase, thus precipitating calcium carbonate from saturated to supersaturated waters.

As discussed in Chapter 3, alternating light and dark laminae are a recognizable feature of stromatolites (Fig. 4.1), and they result from the periodic or episodic nature of accretion processes (Hofmann 1973). An additional feature present in some samples is a very fine, opaque lamination that may represent micritization by endolithic algae (Link et



Figure 4.1 Close-up of stromatolite laminae from the Hastings Formation, Broad Cove Chapel. The laminae consist of alternating couplets of dark, organic matter-rich and light coloured layers of trapped carbonate mud.

al. 1978).

The formation of fenestral textures, common to the micritic laminae of the stromatolites, may result from a variety of processes. Monty (1976) discussed several of these processes including: (1) shrinkage and drying of the mat that causes widespread detachment from underlying layers along organic partings; (2) generation of gas bubbles during photosynthesis or bacterial decomposition in which rising bubbles distort the grain packing; (3) active growth resulting in rapid lateral expansion; and (4) the result of decay of organic matter, leaving voids.

A combination of biological and environmental factors is responsible for stromatolite shaping. Environmental forces may influence stromatolite morphology directly by trimming and shaping (Golubic 1991). Forces that influence the shape of stromatolites include: periodic wetting and drying by the fluctuation of tidal waters; prolonged periods of desiccation during low tides in the marine environment, and by evaporation of water in shallow lakes and salinas; and the scouring and mechanical fragmentation by storm waves (Logan et al. 1964).

4.2.2 Intraclasts

Flat-pebble conglomerates composed of intraclasts enclosed in a sparry to micritic calcite cement commonly occur with stromatolites. Intraclastic carbonates generally occur in beds immediately above or below the associated stromatolites. Non-algal carbonate intraclasts may have come from fragments of reworked muds that underlie the stromatolites, whereas algal fragments originated from nearby stromatolites.

Flat-pebble conglomerates represent a transgressive lag deposit formed when a very shallow lake expanded over an exposed mud flat. During periods of regression, muds and stromatolites were exposed and subjected to desiccation cracking. Processes of drying and algal mat binding made these clasts coherent enough for high-energy wave transport (Eugster and Hardie 1975). In the Bahamas, intraclasts form by storm waves ripping up polygonally cracked, algal-bound laminated sediments, and then redepositing them nearby (Eugster and Hardie 1975).

Intraclasts enclosed in a sparry cement suggest that mud did not occupy the pore spaces around the intraclasts during cementation. Thus, the intraclasts were either deposited by currents that winnowed muds out of the pore spaces, or the intraclasts accumulated too rapidly for the mud to contaminate them (Dunham 1962). A muddy or micritic matrix between intraclasts may indicate relatively quiet waters in which active currents did not wash terrigenous sediment out of the pore spaces. The micrite may alternatively have infiltrated the pore-spaces of the sediments after deposition. Without pore space available between the grains, no room exists for calcite to precipitate.

Pore-filling cement generally develops in environments where water occupies the pore spaces allowing precipitation of calcite crystals without obstacles, for example a phreatic environment (Carozzi 1993). The first cement may nucleate on crystals on the surfaces of the grains and grow outward to produce a bladed active isopachous calcite rim (Longman 1980). Cements that form around the grains consist of spar calcite that coarsens towards the centre of the pore space, resulting in an interlocking mosaic. This type of cement characterizes an active freshwater phreatic zone.

4.2.3 Ooids

Conditions most favourable for the formation of ooids include warm, clear, shallow, wave-agitated marine and hypersaline waters saturated with respect to calcium carbonate (Swirdyczuk et al. 1979; Reijers and ten Have 1983). In modern environments, ooids form where calcium carbonate precipitates because of a rapid loss of carbon dioxide and an increase in salinity in warm shallow waters generally less than two to five metres in depth (Simone 1981). The rate of sediment influx must be low to allow the ooids to develop.

The arrangement of ooid fibres provides information about energy level of the waters in which the ooids formed. Laboratory experiments involving ooid formation (Davies et al. 1978) suggested that quiet water ooid types exhibit a radial orientation of carbonate crystals. Those formed in agitated conditions exhibit a tangential orientation. Turbulence and periodic abrasion may modify radial fibres to tangential fabrics in higher energy environment by mechanically flattening the ooid surfaces (Davies et al. 1978). Tangentially arranged crystals form the thin concentric rings that alternate with radially arranged crystals of ooids. Concentric internal structures result from slow precipitation around nuclei in agitated waters supersaturated with respect to calcium carbonate. Radial textures form in slightly deeper waters where weakly agitated, but still calcium carbonate supersaturated, waters exist (Reijers and ten Have 1983). Ooids that exhibit a radial fabric in the interior and concentric growth on the exterior (Fig 4.2), may reflect growth starting in low energy waters and undergoing increasing agitation with time (Reijers and ten Have 1983). Generally, quiet water ooids grow asymmetrically because the rounding effect of

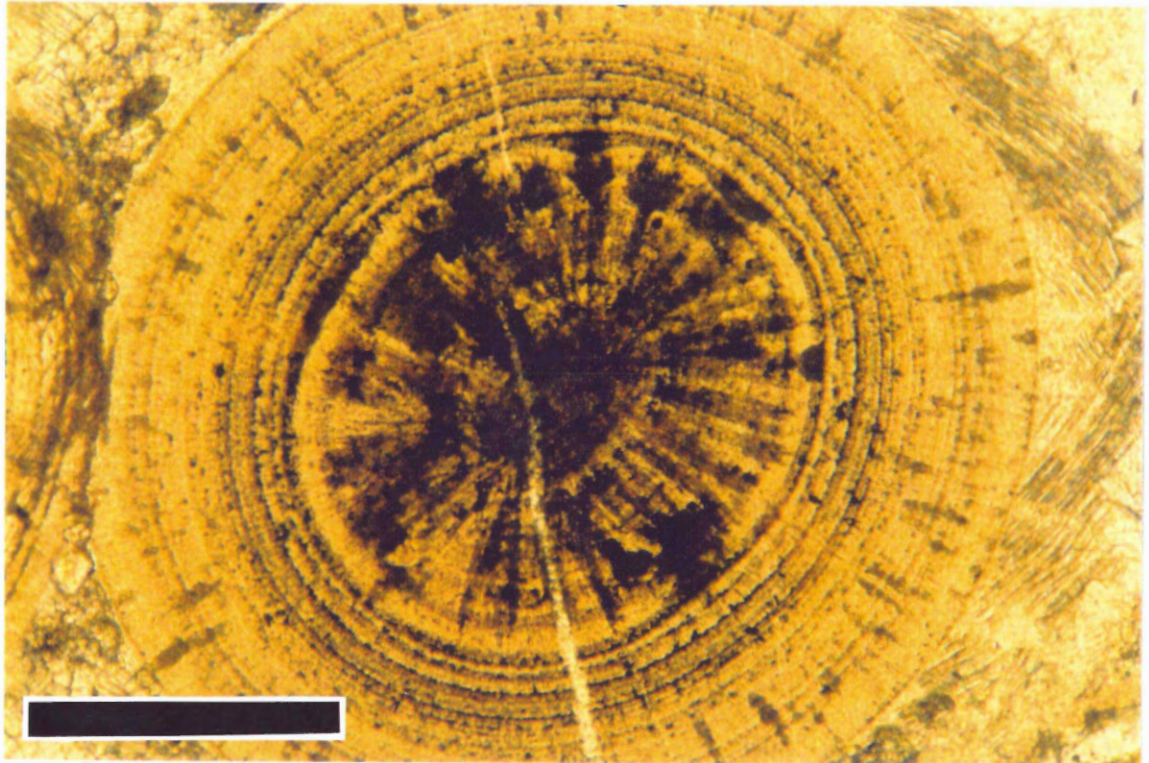

Figure 4.2 Ooid in which the inner cortex exhibits a radial texture and the outer cortex has a prevalent concentric structure. Sample comes from the Hastings Formation, Ainslie Point (scale bar =0.25 mm) PPL.

mechanical abrasion is lacking (Strasser 1986).

Samples from Southwest Mabou River show a meniscus cement as micrite around ooids. Meniscus cements form in vadose environments related to a loss of carbon dioxide, as in ooid production (Sellwood 1986). Generally, a meniscus cement forms when capillary forces hold water between grains in zones where the pores periodically contain water, as in a vadose zone (Longman 1980).

Superficial ooids are those in which the thickness of the cortex is less than half the radius of the nucleus with only one or two laminae in the cortex (Flügel 1982). The laminae in the cortex occur as very thin radially fibrous isopachous rims that give these grains and ooid-like appearance. Isopachous rims of finely fibrous calcite cement commonly form in mixed marine-freshwater vadose environments (Carozzi 1993).

Some samples have stylolites and sutured contacts between ooids, suggesting that the oolites underwent compaction following their formation. Stylolites cut across the ooids, cement, and matrix within the rock because of overburden stress. Localized strain in saturated solutions cause grains to undergo pressure-dissolution along their contacts, resulting in the formation of sutures (Bathurst 1975).

4.2.4 Peloids

The lack of internal structure in peloids creates problems in determining their exact origin. Possible origins of peloids include: (1) grains completely micritized by endolithic microorganisms (Carozzi 1993); (2) precipitated calcite within and around clumps of bacteria, with precipitation induced by the vital activity of bacterial colonies (Chafetz

1986); and (3) small and rounded intraclasts of structureless carbonate reworked and transported by mechanical processes (Carozzi 1993).

The individual peloids within the Southwest Mabou River section (Fig. 3.13) display colours ranging from black in the centre and light brown towards the exterior. The composition of the peloids consists of dense micrite and their origin is difficult to determine.

4.2.5 Serpulids

Well-preserved calcareous tubes secreted by serpulid worms occur within carbonate rocks of the Mabou Group. Serpulids commonly occur with algal laminates and stromatolites in intertidal and shallow subtidal carbonate sediments which form deposits generally regarded as restricted lagoonal facies (Burchette and Riding 1977). Serpulids tolerate a broad range of salinity including brackish to marine waters (Burchette and Riding 1977; Tasch 1980; Weedon 1990). Their presence suggests possible elevated salinity.

4.3 Associated Lithofacies

Sedimentary rocks of the lower Mabou Group consist predominantly of fine-grained clastic rocks in the form of siltstones, fine-grained sandstones, or shales. Fine-grained dominated facies containing fine laminations, gypsum, and laterally persistent beds are typical of lacustrine environments (Picard and High 1972).

4.3.1 Siltstones

Grey siltstones, which predominate in the Mabou Group grey facies, consist of rhythmic laminations made up of organic-rich and carbonate-rich couplets. These laminated sediments are a characteristic feature of lake-basin deposits, representing seasonal variations in sediment supply and organic productivity (Tucker 1978). Their grey colouring and well-preserved laminae suggest that reducing conditions existed where few grazers lived. Horizontal pyrite laminations in the siltstones also provide evidence for a reducing environment, at least for part of the history of the lake. Minor, small-scale, straight-crested ripples and mud cracks suggest that waters of the lake were relatively shallow. Laminated dolomitic mudstones that occur as resistant beds within the laminated siltstones record quiet water sedimentation of carbonate material out of suspension (Gómez Fernández and Mélendez 1991).

Not all the siltstones are grey, nor are they all laminated. They may occur as grey, green, or red massive, blocky siltstones with conchoidal fracture (Fig 3.16). Other fine-grained clastic rocks within the lower Mabou Group consist of dark grey to black bituminous shales that may result from the accumulation of organic material under anaerobic conditions.

4.3.2 Sandstones

Sandstones, as mentioned in Chapter 3, generally occur in fining-up sequences. The sandstones in the lower Mabou Group consist predominantly of red and green fine- to medium-grained quartz-rich sands. They exhibit such features as climbing ripples, cross-

stratification, and a calcareous matrix. Belt (1968) defined similar fining-upward sequences within the Mabou Group red facies as fluvial channel sandstones, suggesting that rivers occasionally flowed into the lake or over exposed parts of the lake bottom. Exposure of the sediments resulted in oxidation of the sediments and prolonged exposure resulted in the establishment of plants. Some sandstones exhibit a mottled or variegated nature, possibly because of the presence of plant roots that formed reduction spots in the red sediments.

The red bed fining-upward sequences do not occur in sections from eastern Cape Breton Island. The absence of red beds from the grey facies of eastern Cape Breton Island suggests deeper water deposition than the grey facies of western portion of Cape Breton Island.

Gypsum

Gypsum occurs in the lower 40 metres of the grey facies, suggesting that high salinity waters still existed following deposition of the Windsor Group. Gypsum at this stratigraphic position is included in the Mabou Group rather than the Windsor Group, based on lithostratigraphic divisions. The E1 or Dixon Point Limestone Member, as previously mentioned, represents the highest regionally extensive limestone of the Windsor Group, thus making it a good marker bed. The gypsum overlying this limestone does not make a good marker for the top of the Windsor because of its tendency to dissolve.

Gypsum and anhydrite form through precipitation from brine as a result of evaporation, generally beginning precipitation when waters reach a concentration of 3.8

times that of seawater (Kendell 1989). Evaporites may originate from evaporation of seawater or groundwater of continental settings. The two principal modes of evaporite deposition are: (1) subaqueous precipitation, from a shallow- to deep-water body (lake, lagoon or rift basin); and (2) subaerial precipitation, taking place within sediments or in very shallow to desiccated saline pans (Tucker 1991).

4.4 Summary

The identification and interpretation of many different types of carbonate rocks and sedimentary structures in the Mabou Group provide important information about the environment of deposition. Chapter 5 investigates the depositional setting in more detail, providing information about proposed environments of the underlying Windsor Group and the overlying Mabou Group red facies.

Chapter 5: Discussion and Conclusions

5.1 Introduction

Reconstruction of the depositional environment depends on interpretation of carbonate rocks of the Mabou Group and their associated lithofacies. This chapter provides an outline of the depositional environment of the Mabou Group grey facies, and some discussion about the positions of the carbonates in the lake.

5.2 Depositional Environment

At the time of Mabou Group deposition, Cape Breton Island, positioned near the equator, existed within a semi-arid to arid climate (Rowley et al. 1985). Underlying sediments comprising the Windsor Group represent a seasonally semi-arid climate. Conditions of the Windsor Group likely prevailed during early deposition of the Mabou Group, with no obvious breaks in sedimentation occurring between the Mabou and Windsor Groups.

Desiccation cracks, variegated red-green sandstones and siltstones, halite pseudomorphs, stromatolites, intraclastic carbonates, or flat-pebble conglomerates, and gypsum within the Mabou Group suggest shallow water deposition. Flat-pebble conglomerates represent episodic rises in water level as waters transgressed over exposed sediments and stromatolites. The presence of pyrite laminations, ooids, and finely laminated grey siltstones and shales suggests higher water levels. Pyrite laminations

indicate a reducing environment, and the finely laminated grey clastic rocks suggest a standing body of water. Well-preserved laminations in the siltstones suggest that these sediments were not bioturbated by roots or burrowing organisms. The scarcity of fossils suggests hostile conditions for life, possibly resulting from high salinity and/or episodic exposure, or lack of oxygen.

The types of carbonate rocks and sedimentary structures of the Mabou Group grey facies suggest lacustrine deposition. The type of lake system suggested for the Mabou Group consisted, at least in part, of a hydrologically closed shallow lake system (ephemeral lake). Ephemeral lakes are subject to repeated climatically-controlled expansions and contractions, as well as variations in salinity levels (Platt and Wright 1991). Sediments at the base of the Mabou Group resemble an ephemeral saline lake. Saline lakes generally develop in arid to semi-arid climates where large shallow lakes experience fluctuations in water level related to the amount of precipitation and evaporation. Conditions necessary for the formation of a saline lake include: (1) evaporation must exceed inflow; (2) the basin should be hydrologically closed, or at least, outflow must be restricted (Hardie et al. 1978).

Gypsum in the lower part of the Mabou Group suggests high salinity related to marine influences from the underlying Windsor Group as well as periods of evaporation. Gypsum eventually decreased in quantity until no gypsum remained, suggesting a gradual change in lake conditions, possibly related to a general decrease in water salinity. Copeland (1957) noticed a decrease in water salinity progressively up the stratigraphic section, based on fossil evidence. Fossils present in the lower part of the Mabou Group,

near the Windsor Group, consist of brackish-water ostracod species of *Paraparchites*. Freshwater varieties replaced these fossils higher in the Mabou Group, including non-marine species of *Tealliocaris* (arthropods) and *Carbonita* (ostracods) (Copeland 1957). As time passed, the dynamics of the lake changed, either in terms of climate or drainage, causing the lake to become fresher. Changes in the deposition of the Mabou Group from gypsum to predominantly freshwater and brackish sediments may result from climatic changes, increased freshwater inflow causing a decrease in water salinity, or increased subsidence with respect to sedimentation in the central part.

Deposition of the Mabou Group changed from a lacustrine to a fluvatile environment, as represented by the eventual coarsening and dominance of red beds. The presence of red fluvatile deposits in the grey facies and grey lacustrine sediments in the red facies suggests a gradual transition in depositional settings. Transition of the Mabou Group from a lacustrine environment to a fluvatile environment may result from changes in tectonics, climatic, or the amount of sediment fill in the lake.

5.3 Facies Relationships

The lake, in which the Mabou Group formed, existed as a regionally extensive shallow body of water. Sediments of the grey facies from western Cape Breton Island suggest shallow water deposition with a fluctuating shoreline. Evidence of regression and transgression appears in the sediments, suggesting continual fluctuations in water level in which the position of the lake shoreline was constantly changing. A small decrease in water level would cause the lake to contract and expose large areas to desiccation and,

conversely, a small increase in water level would cause the lake to expand over the previously exposed bottom. In this region, the bottom of the lake appears to have been gently sloping with little to no development of a deep water facies.

Sediments of the Mabou Group grey facies from the eastern portion of Cape Breton Island appear to represent a deeper water facies than in the west. Thus, sedimentary rocks of the Mabou Group show a general trend of shallow water deposition in the west and deeper water deposition in the east. The reason for this trend in deposition is difficult to determine because outcrops of the Mabou Group are scattered across Cape Breton Island. Suggestions for this include that the lake into which the Mabou Group was deposited extended across Cape Breton Island with a gently sloping bottom, or sediments in the west represent a different lake system than sediments in the east.

In the lower Mabou Group major lacustrine facies occur, including the shoreline facies, nearshore facies, and offshore facies (after Link et al . 1978), as discussed below (Table 5.1).

5.3.1 Shoreline Facies

The shoreline facies of the Mabou Group consists of well-sorted, horizontally laminated and rippled sandstone, interbedded and transitional to lacustrine mudstone. Common features in the sandstone and siltstone include climbing ripples, ripple marks, desiccation cracks, calcareous matrix, and flat-pebble conglomerates. Red sandstones and siltstones in this facies suggest prolonged periods of exposure. The presence of ripples in this facies suggests wave agitation and flat-pebble conglomerates imply local reworking.

Located along the shore, this zone experienced effects of channel runoff and streams that carry in terrigenous material. Evidence of streams existing within the lake environment occurs in the lower Mabou Group as fining-upward red bed sequences. These units, as earlier described, are massive at the base with mud chip intraclasts and become very fine-grained and rippled at the top. The shoreline facies occurs in sections from western Cape Breton Island but not in those from the east.

5.3.2 Nearshore Facies

Stromatolites and grey siltstone dominate the nearshore facies environment. Sedimentary structures consist of calcareous laminated siltstones, flat-pebble conglomerates, and desiccation cracks suggesting that shallow, fluctuating water levels characterize the nearshore facies. Other carbonates in this facies, generally associated with the stromatolites, include intraclastic carbonates, or flat-pebble conglomerates, ooids,

	Shoreline Facies	Nearshore Facies	Offshore Facies
Sedimentary Features	channel deposits mudcracks red beds ripple marks	laminations mud cracks ripple marks	laminations pyrite black shales
Carbonates	intraclastic carbonates stromatolites	intraclasts stromatolites ooids peloids	stromatolites dolomitic mudstones

Table 5.1 Characteristics typical of each of the lacustrine facies within the Mabou Group.

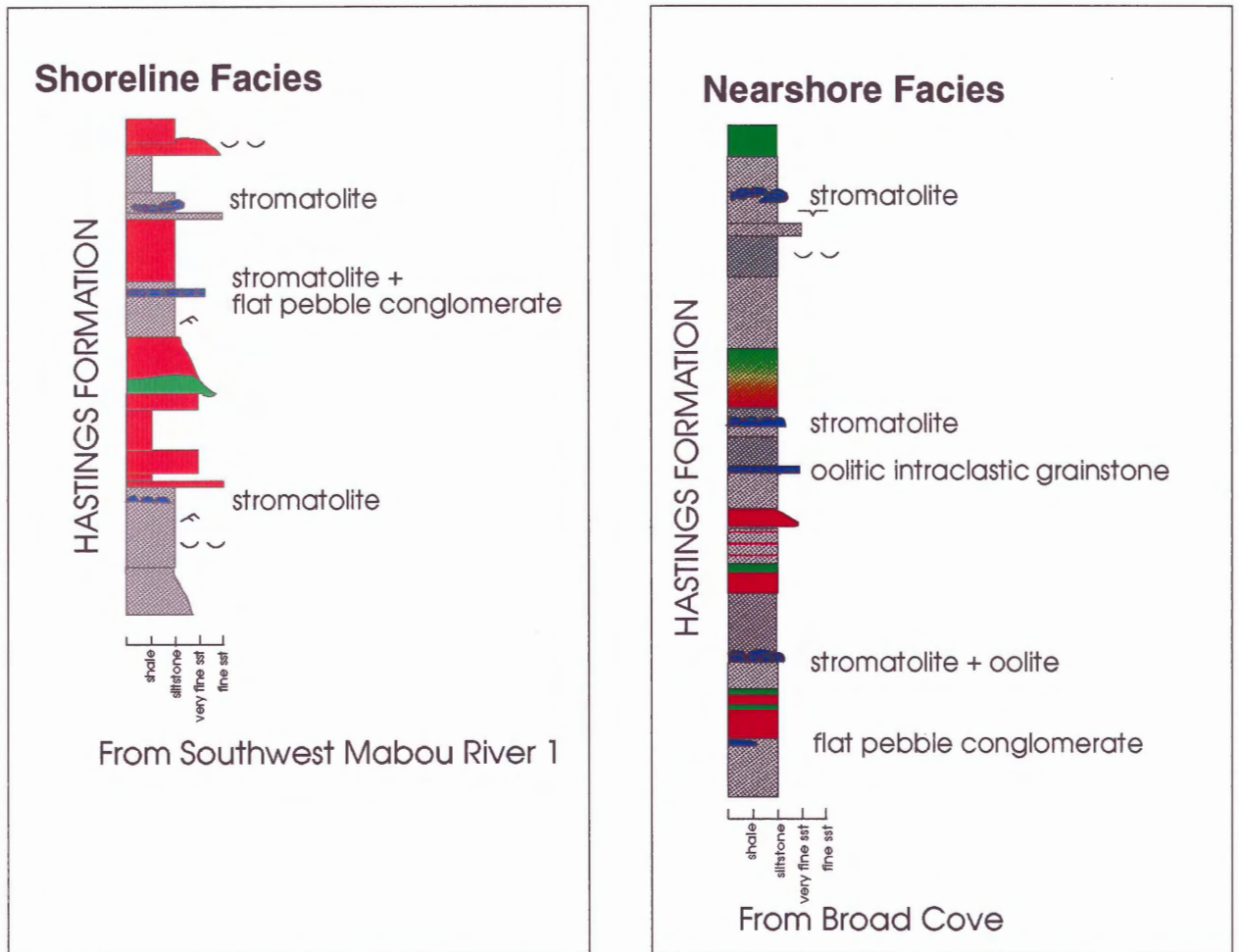

- ⌋ swaley siltstones
- ⌋ ripple marks
- ⌋ mud cracks
- carbonate rocks
- green clastic rocks
- dolomitic mudstone
- red clastic rocks
- grey clastic rocks

Figure 5.1 Examples of the shoreline and nearshore facies from the lower Mabou Group.

Ooids form in agitated waters that are not subaerially exposed, suggesting that they formed in the deeper parts of the nearshore environment where an effective wave base intersects the bottom surface. The ooids formed in the agitated waters may then wash into adjacent environments, with a small percentage trapped within stromatolite laminae, as noted in some carbonate rocks. Ooids also occur in association with intraclasts derived from algal mats, suggesting movement from their area of formation. In an agitated environment little mud can settle out in pore spaces between the ooids, thereby resulting in oolitic grainstones. In cases where the ooids have moved to a neighbouring environment, deeper water conditions may allow muds to accumulate, resulting in the formation of oolitic packstones and wackestones.

Serpulids probably lived in the nearshore facies because they require clear waters with low to moderate amounts of turbidity. If turbidity levels are too high, the worms, being suspension feeders, will choke because clay and silt clogs their feeding apparatuses (Heckel 1972).

5.3.3 Offshore Facies

The offshore facies represents deeper lake levels where finely laminated dark grey siltstones and shales accumulate (Fig. 5.2). In these deeper waters, below the fair weather or storm wave base, water with low turbidity levels allows fine sediments to settle out, thereby depositing mud and sand-size carbonate material. Other features of this facies include pyrite laminations and an absence of fossils, suggesting oxygen-depleted bottom waters. Accumulations of black bituminous shales in this facies also imply anoxic

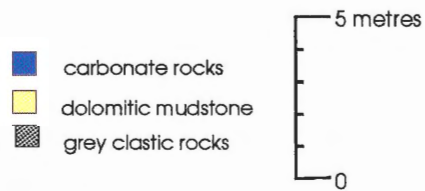
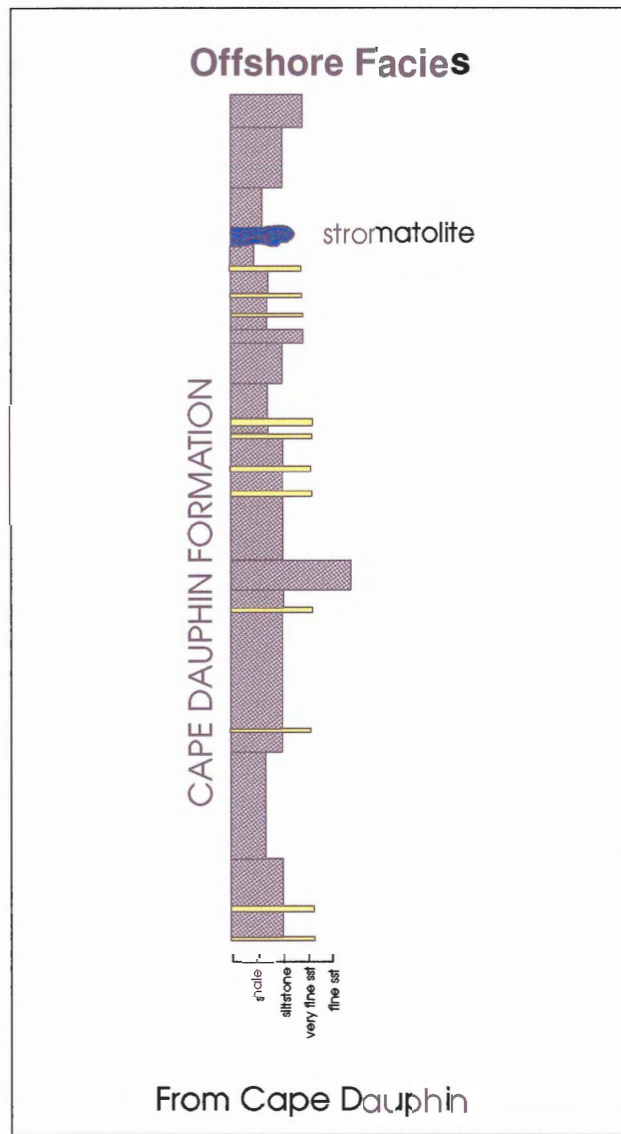

Figure 5.2 Example of offshore facies from the lower Mabou Group.

conditions dominated in this zone. The preservation of finely laminated sediments that have remained undisturbed by burrowing or grazing organisms suggests few organisms lived in this environment. No evidence of subaerial exposure exists in the offshore facies, suggesting that the environment was more stable than the shallower water environment.

The offshore facies rarely occurs in the lacustrine environment of the Mabou Group of western Cape Breton, probably because of the fluctuating shoreline and a relatively flat bottom which prevented continuous subaqueous deposition. In eastern Cape Breton the offshore facies dominates the grey facies of the Mabou Group.

5.4 Conclusions

The Mabou Group grey facies, regionally extensive across Cape Breton Island, represents a lacustrine environment. Deposition of the Mabou Group grey facies followed the retreat of Windsor seas(?), with similar conditions still existing when Mabou Group deposition began. The underlying Windsor Group, deposited in a seasonally semi-arid climate, exists over a gently sloping bottom across Nova Scotia. Sediments in western Cape Breton appear to represent slightly shallower water deposition than the eastern portion.

Conditions persisting during the early stages of the Mabou Group consisted of a semi-arid climate. The lake underwent large fluctuations in water and salinity levels throughout its history until it evaporated or was filled in, and a fluvial environment was established. The change from lacustrine to fluvial was transitional, as shown by red beds in the grey facies. These red beds become increasingly thick and more abundant

toward the top of the grey facies.

Carbonate rocks within the Mabou Group grey facies, including stromatolitic bindstones and oolitic and peloidal carbonates, represent shallow water deposition. Serpulids within the carbonate rocks also attest to shallow water deposition. Each type of carbonate rock contributes to the reconstruction of the depositional setting of the lake environment, providing clues about energy, relative depth, and shoreline position. The carbonate rocks alone do not provide the complete picture, thus demonstrating the importance of measuring stratigraphic sections in detail. Detailed descriptions of sections and related sedimentary structures, such as mud cracks, pyrite laminations, and ripple marks, permitted a more complete determination of the environment in which the carbonate rocks occur.

References

- Bathurst, R.G.C. 1975. Carbonate Sediments and Their Diagenesis. Elsevier, Amsterdam.
- Bell, W.A. 1944. Carboniferous rocks and fossil floras of northern Nova Scotia. Canada Geological Survey, Memoir, 238. pp. 277.
- Bell, W.A. 1958. Possibilities for Occurrence of Petroleum Reserves in Nova Scotia. Nova Scotia Department of Mines Report. pp. 177.
- Bell, W.A. 1960. Mississippian Horton Group of the type Windsor-Horton District, Nova Scotia. Geological Survey of Canada, Memoir, 314. pp. 112.
- Bell, W.A. and Goranson, E.A. 1938. Sydney Sheet (west half). Department of Mines and Resources, Canada, Map 360A.
- Belt, E.S. 1964. Revision of Nova Scotia Middle Carboniferous Units. American Journal of Science, **262**: 653-673.
- Belt, E.S. 1965. Stratigraphy and Paleogeography of Mabou Group and Related Middle Carboniferous Facies, Nova Scotia, Canada. Geological Society of America Bulletin, **76**: 777-802.
- Belt, E.S. 1968. Carboniferous Continental Sedimentation, Atlantic Provinces, Canada. In G. de V. Klein (Ed.), Late Paleozoic and Mesozoic Continental Sedimentation, Northeastern North America. Geological Society of America, Special Paper 106: 127-176.
- Boehner, R.C. 1984. Sydney Basin Project - An update. Nova Scotia Department of Mines and Energy Report 84-1. pp. 49-60.
- Boehner, R.C. and Prime, G. 1993. Geology of the Loch Lomond Basin and Glengarry Half Graben, Richmond and Cape Breton Counties, Cape Breton Island, Nova Scotia. Nova Scotia Department of Natural Resources, Mines and Energy Branches, Memoir 9. pp. 68.
- Burchette, T.P. and Riding, R. 1977. Attached vermiform gastropods in Carboniferous marginal marine stromatolites and biostromes. *Lethaia*, **10**: 17-28.
- Carozzi, A.V. 1993. Sedimentary Petrography. PTR Prentice-Hall, Englewood Cliffs.

- Chafetz, H.S. 1986. Marine Peloids: A product of bacterially induced precipitation of calcite. *Journal of Sedimentary Petrology*, **56**: 812-817.
- Copeland, M.J. 1957. The arthropod fauna of the upper Carboniferous rocks of the Maritime Provinces: Geological Survey of Canada, Memoir, 286. pp. 110.
- Davies, P.J., Bubela, B. and Ferguson, J. 1978. The formation of ooids. *Sedimentology*, **25**: 703-730.
- Dravis, J.J. 1983. Hardened subtidal stromatolites, Bahamas. *Science*, **219**: 385-386.
- Dunham, R.J. 1962. Classification of carbonate rocks according to depositional texture. In W.E. Ham (ed.), *Classification of Carbonate Rocks*, American Association of Petroleum Geologists Memoir 1: 108-121.
- Embry, A.F. and Klovan, J.E. 1971. A Late Devonian reef tract on Northeastern Banks Island, N.W.T. *Bulletin of Canadian Petroleum Geology*, **19**: 4.
- Eugster, H.P. and Hardie, L.A. 1975. Sedimentation in an ancient playa-lake complex: The Wilkins Peak Member of the Green River Formation, Wyoming. *Geological Society of America Bulletin*, **86**: 319-334.
- Folk, R.L. 1962. Spectual Subdivision of Limestone Types. In W.E. Ham (ed.), *Classification of Carbonate Rocks*, American Association of Petroleum Geologists Memoir 1: 62-84.
- Flügel, E. 1982. *Microfacies Analysis of Limestones*. Springer-Verlag, Berlin
- Giles, P.S. 1983. Sydney Basin Project. Nova Scotia Department of Mines and Energy Report 83-1. pp. 57-70.
- Golubic, S. 1991. Modern stromatolites: A review. In R. Riding (Ed.) *Calcareous Algae and Stromatolites*. Springer-Verlag, Berlin Heidelberg. pp. 541-561.
- Gómez Fernández, J.C. and Meléndez, N. 1991. Rhythmically laminated lacustrine carbonates in the Lower Cretaceous of La Serranía de Cuenca Basin (Iberian Ranges, Spain). In P. Anadón, Ll. Cabrera, and K. Kelts (Eds.) *Lacustrine Facies Analysis*. Special Publication Number 13 of the International Association of Sedimentologists. pp. 245-256.
- Graham, R.C. and Southard, A.R. 1983. Genesis of a vertisol and an associated mollisol in Northern Utah. *Soil Science Society of America Journal* **47**: 552-559.

- Hardie, L.A., Smoot, J.P., and Eugster, H.P. 1978. Saline lakes and their deposits: a sedimentological approach. In A. Matter and M.E. Tucker (Eds.) *Modern and Ancient Lake Sediments*. Special Publication Number 2 of the International Association of Sedimentologists. pp.7- 41.
- Hofmann, H.J. 1973. Stromatolites: Characteristics and Utility. *Earth-Science Reviews*, **9**: 339-373.
- Jones, B.F. and Bowser, C.J. 1978. The mineralogy and related chemistry of lake sediments. In Lerman, A. (Ed.) *Lakes: Chemistry, Geology and Physics*. Springer-Verlag, New York. pp. 179-235.
- Leeder, M.R. 1982. *Sedimentology: Process and Product*. Harper-Collins Academic, London. pp. 17-19.
- Link, M.H., Osborne, R.H., and Awramik, S.M. 1978. Lacustrine stromatolites and associated sediments of the Pliocene Ridge Route Formation, Ridge Basin, California. *Journal of Sedimentary Petrology*, **48**: 143-158.
- Logan, B.W., Rezak, R. and Ginsburg, R.N. 1964. Classification and environmental significance of algal stromatolites. *Journal of Geology*, **72**: 68-83.
- Longman, M.W. 1980. Carbonate Diagenetic Textures from Nearshore Diagenetic Environments. *American Association of Petroleum Geologists Bulletin*, **64**: 461-488.
- Kendell, A.C. 1992. Evaporites. In R.G. Walker and N.P. James (Eds.) *Facies Models: Response to Sea Level Change*. Geological Association of Canada. pp. 375-407.
- Mather, K.F. and Trask, P.D. 1929. Preliminary report on geology and oil exploration in Cape Breton Island, Nova Scotia: Nova Scotia Department of Mines, Annual Report on Mines 1928: 261-301.
- Moore, R.G. and Austin, I.A. 1979. Herbert River and Musquodoboit Limestone Members, keys to reconstruction of the Fundy Depositional Trough, Late Windsor time, Atlantic Area of Canada. *Compte Rendu* **3**: 179-192.
- Monty, C.L.V. 1976. The origin and development of cryptalgal fabrics. In M.R. Walter (Ed.) *Stromatolites*. *Developments in Sedimentology* **20**. Elsevier, Amsterdam pp. 193-249.

- Neumann, A.C. and Land, L.S. 1975. Lime mud deposition and calcareous algae in the Bight of Abaco, Bahamas: A budget. *Journal of Sedimentary Petrology* **45**: 763-786.
- Neves, R. and Belt, E.S. 1970. Some observations of Namurian and Viséan spores from Nova Scotia, Britain and Northern Spain. *Sixième Congrès International de Stratigraphie et de Géologie du Carbonifère, Sheffield, 1967, Compte Rendu*, **3**: 1233-1249.
- Norman, G.W.H. 1935. Lake Ainslie map-area, Nova Scotia. Geological Survey of Canada, Memoir 177. pp. 103.
- Park, R. 1976. A note on the significance of laminations in stromatolites. *Sedimentology*, **23**: 379-393.
- Picard, M.D. and High, L.R. 1972. Criteria for recognizing lacustrine rocks. In J.K. Rigby and W.K. Hamblin (Eds.) *Recognition of Ancient Sedimentary Environments*. Society of Economic Paleontologists and Mineralogists Special Publication **16**: 108-145.
- Platt, N.H. and Wright, V.P. 1991. Lacustrine carbonates: facies models, facies distributions and hydrocarbon aspects. In P. Anadón, Ll. Cabrera, and K. Kelts (Eds.) *Lacustrine Facies Analysis*. Special Publication of the International Association of Sedimentologists, **13**: 57-74.
- Reijers, T.J.A. and ten Have, A.H.M. 1983. Ooid zonation as indication for environmental conditions in a Givetian-Frasnian carbonate shelf-slope transition. In T.M. Peryt (Ed). *Coated Grains*. Springer-Verlag, Berlin Heidelberg. pp. 188-198.
- Riding, R. 1991. Calcified Cyanobacteria. In R. Riding (Ed.) *Calcareous Algae and Stromatolites*. Springer-Verlag, Berlin Heidelberg. pp. 55-82.
- Rostoker, M.D. 1960. The geology of the Canso Group in the Maritime Provinces, Canada. Ph.D. thesis, Boston University, Boston, Microfilm 60-3484.
- Rowley, D.B., Raymond, A., Parrish, J.T., Lottes, A.L., Scotese, C.R., and Ziegler, A.M. 1985. Carboniferous paleogeographic, phytogeographic, and paleoclimatic reconstructions. *International Journal of Coal Geology*, **5**: 7-42.
- Sellwood, B.W. 1986. Shallow-marine carbonate environment. In H.G. Reading (Ed.) *Sedimentary Environments and Facies*. Blackwell, Oxford pp. 283-342.
- Simone, L. 1981. Ooids: A Review. *Earth-Science Reviews*, **16**: 319-355.

Stacey, M.C. 1953. Stratigraphy and palaeontology of the Windsor Group (Upper Mississippian) in parts of Cape Breton Island, Nova Scotia. Nova Scotia Department of Mines, Memoir 2. pp. 143.

Strasser, A. 1986. Ooids in Purbeck limestones (lowermost Cretaceous) of the Swiss and French Jura. *Sedimentology*, **33**: 711-727.

Surdam, R.C. and Stanley, K.O. 1979. Lacustrine sedimentation during the culminating phase of Eocene Lake Gosiute, Wyoming (Green River Formation). *Geological Society of America Bulletin*, **90**: 93-110.

Surdam, R.C. and Wolfbauer, C.A. 1975. Green River Formation, Wyoming: a playalake complex. *Geological Society of America Bulletin*, **86**: 335-345.

Swirydczuk, K., Wilkinson, B.H., and Smith, G.R. 1979. The Pliocene Glens Ferry Oolite: Lake-margin carbonate deposition in the southwestern Snake River Plain. *Journal of Sedimentary Petrology*, **49**: 995-1004.

Tasch, P. 1980. Paleobiology of the Invertebrates: Data Retrieval From the Fossil Record. John Wiley and Sons, New York Chichester Brisbane Toronto, pp. 441-470.

Tucker, M.E. 1978. Triassic lacustrine sediments from South Wales: shore-zone clastics, evaporites and carbonates. In A. Matter and M.E. Tucker (Eds.) *Modern and Ancient Lake Sediments*. Special Publication Number 2 of the International Association of Sedimentologists. pp.205-224.

Utting, J. 1987. Palynology of the Lower Carboniferous Windsor Group and Windsor-Canso boundary beds of Nova Scotia and their equivalents in Quebec, New Brunswick and Newfoundland. *Geological Survey of Canada Bulletin*, 374. pp. 93.

Walter, M.R. 1976. Introduction. In M.R. Walter (Ed.) *Stromatolites*. *Developments in sedimentology* 20. Elsevier, Amsterdam. pp. 1-15.

Weedon, M.J. 1990. Shell structure and affinity of vermiform 'gastropods'. *Lethaia*, **23**: 297-309.

Appendix A: General Descriptions of Measured Sections

Ragged Point (Little Judique Harbour)

The E1 Limestone Member at the top of the Windsor Group is well exposed at Ragged Point. Immediately above the Windsor-Mabou contact, gypsum and thick gypsiferous siltstone with interbedded sandstone occurs. These rocks, brecciated and greatly deformed by local folding, make detailed descriptions in the lowermost part difficult. Above the highest gypsum of the Mabou Group, the beds show less distortion and are easier to interpret. The sedimentary rocks within the Ragged Point section consist of grey and red siltstone and sandstone, gypsum, grey dolomitic mudstones, and scarce carbonate rocks. Carbonate rocks that exist in this section lie between beds of grey siltstones. The thickness of the grey facies at Ragged Point reaches roughly 170 metres. The unit grades from dominantly grey to red. The top of the grey facies is arbitrarily placed where red colours become predominant.

Southwest Mabou River sections

Well-exposed sedimentary rocks of the Mabou Group occur on the banks of the Southwest Mabou River. Two sections were measured from the Southwest Mabou River: (1) dominantly grey fine-grained clastic rocks, 85 metres thick, are exposed near the Windsor Group before grading into a red tongue of the Mabou Group; and farther downstream, (2) another 50 metres is exposed in the cliffs along the river bank where the river crosses an abandoned railway bridge.

Immediately above of the E1 Limestone of the Windsor Group, exposed upstream from a measured section, a large section (> 100 m) of the Mabou Group is covered. Gypsum lies immediately about the E1 Limestone, within the missing section. Sedimentary rocks from the Southwest Mabou sections consist of cycles of grey siltstones, carbonate, grey siltstones, red sandstones, and red siltstones. The thickness of these cycles varies throughout the section. Grey siltstones occur both on the top and bottom of the carbonate rocks. The dominant lithology of the sedimentary rocks along the Southwest Mabou River consists of laminated grey-buff siltstones with interbedded dolomitic mudstones.

Ainslie Point, North Lake Ainslie

The section measured at Ainslie Point along the north shore of Lake Ainslie is small (only 28 metres thick). The basal contact with the Windsor Group is not exposed and the upper contact with the Pomquet Formation is faulted. This section, although incomplete, contains a massive oolite and well-preserved, laterally-linked hemispheroidal stromatolites. The sedimentary rocks of the Hastings Formation exposed at Ainslie Point consist of alternating grey and red siltstones, and minor sandstone beds.

Broad Cove Chapel

The shoreline at Broad Cove Chapel provides an excellent exposure of the Hastings Formation, bounded at the bottom by the E1 Limestone, and gradational at the top into the Pomquet Formation. This section is the thickest of the sections measured (230 metres), before grading into dominantly red fine-grained clastic rocks. The

sedimentary rocks of the Hastings Formation consist mainly of grey-buff laminated siltstones with interbedded dolomitic mudstones and non-laminated grey siltstones. Other clastic rocks include red and green siltstones and sandstones. Carbonate rocks, lying on top of grey siltstones and overlain by either grey or green siltstones, are plentiful and diverse.

Cape Dauphin

The Cape Dauphin section, of the Sydney Basin, contains only grey fine-grained clastic rocks and thin carbonates. The 90 metre thick section is marked by the Dixon Point Limestone at its base and the Morien Group at the top. Fifteen carbonates occur within this section, ten of which are stromatolitic bindstones.

Woodbine Road Drill Hole

The Mabou Group does not crop out well in the Sydney Basin, thus the drill core provides a better understanding of the sediments. In this core, the base of the Mabou is in contact with the Dixon Point Limestone, and the top is noted by the dominance of red sedimentary rocks. Gypsum and anhydrite, interbedded with grey fine-grained clastic rocks, are well-preserved in the core immediately above the Windsor-Mabou contact. The rest of the section consists of grey sedimentary rocks and thin carbonates. Red beds occur near the top of the section, where a transition into the overlying Point Edward Formation takes place.

Amax Exploration Drill Hole BB74-4

The Amax drill hole BB74-4 contains the type section of the MacKeigan Lake Formation. Sedimentary rocks within the drill hole represent the Mabou Group of the Loch Lomond Basin, where outcrop is scarce. Grey fine-grained sandstones and siltstones and interbedded gypsum dominate in the lower two thirds of the MacKeigan Lake Formation section. Predominantly red sandstones and siltstones, still of the MacKeigan Lake Formation, overlie the grey sedimentary rocks.

Appendix B: Stratigraphic Sections

The following figure displays all stratigraphic sections and drill core measured. The positions of the carbonate rocks have been noted on the figure.

STRATIGRAPHIC SECTIONS FROM CAPE BRETON ISLAND OF THE MABOU GROUP GREY FACIES

