

**UPDATING LIBRARY,
ARCHITECTURAL ADAPTATION IN RESPONSE TO
THE VIRTUAL SPACE OF THE INTERNET**

by

Phillip Wilson Mallysh

Submitted in partial fulfilment of the requirements
for the degree of Master of Architecture

at

Dalhousie University
Halifax, Nova Scotia
November 2013

© Copyright by Phillip Wilson Mallysh, 2013

CONTENTS

Abstract	iii
Acknowledgments	iv
Chapter 1: Introduction	1
Updating	3
Heterotopia	7
Chapter 2: Library Now.....	9
Conception (1960)	9
Physical Storage.....	12
Cloud(y).....	14
Chapter 3: Design.....	19
Information Core	19
Vertical Acceleration	21
Expansion Layer.....	26
Data Centre	28
New(est) Nature	31
Machine System	33
Establishing a New Plane	35
Extension, The Conveyor	38
Information Loop.....	48
Study Ring	55
Isolation Gardens	59
Chapter 4: Conclusion	62
References	63

ABSTRACT

The explosion of new technologies, predominantly the increased inhabitation of the virtual space of the Internet, implies an emergent organization that challenges the existing structures of our established institutions. To understand how this shift; affects architecture, a physical construct, an existing university library (Killam Library at Dalhousie University in Halifax, Canada), is examined through its conception, implementation and subsequent use in order to be updated into the present condition. With the shift in format from the book to the digital realm the false perception of the Internet as a cloud describes society's willingness to negate the physicality of information and transfer power towards large private corporations. Using architectural adaptation, the physicality of information can be re instated by representing equally and intensifying moments of stasis and movement. With the arising situation and the misconceptions that follow call for the re-examination and updating of the library typology to offer new spatial arrangements back to the public that are representative of the contemporary condition.

ACKNOWLEDGMENTS

First, I must thank my studio peers from the 2013 graduating class and others, for creating an amazing environment in which to share and develop ideas to push the boundaries of what we think we know. It was this incredibly unique experience, with these exceptional individuals, that greatly shaped my thinking these past years and made me who I am today.

Second, to my advisory team: Niall Savage, Stephen Parcell and Catherine Venart - for hanging in there and helping me out on this wild journey.

Last, I cannot express how grateful I am to my Mother, Jennifer Wilson, and Step Dad, David Wilson, for supporting me throughout my architectural education, always allowing me to chase my dreams - wherever they have taken me, no matter how crazy they may seem.

010101000110100001100101001000000111011101101111011100100110110001100100
0010000001101111011011100110110001111001001000000110011101101111011001010
111001100100000011100100110111101110101011011100110010000100000011000100
111100100100000011011010110100101110011011101010110111001100100011001010
1110010011100110111010001100001011011100110010001101001011011100110011100
1011100000110100001010

CHAPTER 1: INTRODUCTION

The library is an important focus of discussion in the contemporary condition with the rapid advancement and widespread use of new information technologies, affecting the way society perceives, stores, accesses, consumes and creates information.

As the building of the library dissolves into a deterritorialized information network, it engenders a drastic disappearance of fixed boundaries and simultaneously outlines a potentially infinite space, open and unlimited in every direction. Encompassing both aspects - concrete delimitation, as well as the potential of unlimited space - the new library constitutes an emergent typology. (Klingmann 2001)

Using Michel Foucault's theory of the heterotopia, this thesis examines the contradictions between the virtual space of the Internet and the real world where architecture exists to update an existing university library into the present condition. (Foucault 1984)

While the new network organization, implied through the increased use of the Internet, may not be able to directly supersede existing centralized structures (as seen in the recent Occupy Wall Street movements and Arab Spring uprisings) it must be taken into serious consideration and utilized to adapt the existing institutions that society has established to structure itself upon.

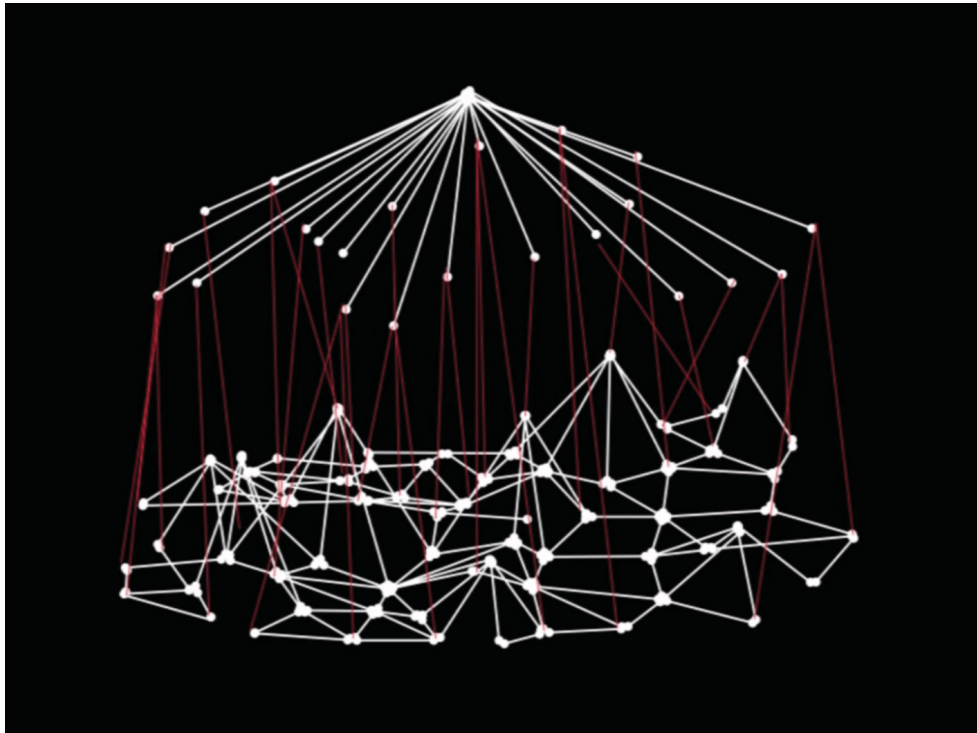

Dan hill, organization conversion (Hill 2012)



Killam Library following completion, 1972 (Dalhousie University 2006)

This conversion process is examined through the adaptation of an existing institutional library (Killam Library, Dalhousie University, Halifax, 1972), acting as a specimen to the broader discussion. By understanding and combining the inherent needs of both an emerging networked public and those of established centralized institutions, the library is updated into a heterotopic space reflective of the contemporary age.

UPDATING

While the typology of the library attempts to encapsulate an ultimate and absolute collection of knowledge, this attempt is inevitably futile - counter to the never-ending creation of “new” knowledge through literally every action that is carried out in its own unique landscape as time unfolds. Like any architectural type, the library must undergo adaptation as well, with the recent explosion in information technology advancements making this an increasingly pressing issue. The library must be updated to reflect current cultural practices of the now globally connected society.

In his essay “Newness Tradition and Identity” Juhani Pallasmaa argues that any act of creation is firmly rooted in the past and that any meaningful act of creation accepts this reality as a departure point, rather than the pursuit of something “new” or alternative (Pallasmaa 2012). This position

does not entail a strict adherence to past traditional practices but rather uses the past as a direct departure point for creation, recognizing it as a shared existential condition of the society to be continually considered, with the possibility to be carried forward through adaptation. He states that

... a respectful attitude to traditions does not imply regressive traditionalism, but its acknowledgement as a source of meaning, inspiration and emotional rooting. (Pallasmaa 2012)

The resulting architecture displays clearly the continuum of time as it unfolds onto and around the users, rather than seducing them within an “ecstasy of newness” that negates its inevitable attachment to both the present condition and the most recent past (Pallasmaa 2012). The past is used as a building block to be edited and utilized for the emergent challenges of the present. In this sense, architecture is not understood as an absolute solution to a given era but rather a transitory device to transport us from one point in time to another, similar to a ship - to use Foucault’s most pertinent example of a heterotopia.

Opposed to the destruction and complete replacement of the existing library, a process is undertaken to analyze the original intention of the building and how it has been utilized and adapted over time into the present condition.

The following chapters blend the act of design with a reading of past fragments of history

surrounding the existing library. These are made critical by a collision with the contemporary practices and behaviors that catapult the library device into the present condition. As the process unfolds, spaces emerge that speak to the present condition acting as an updated scaffolding that provides an external space where new behaviours and desires can be explored.

Killam Library Updates

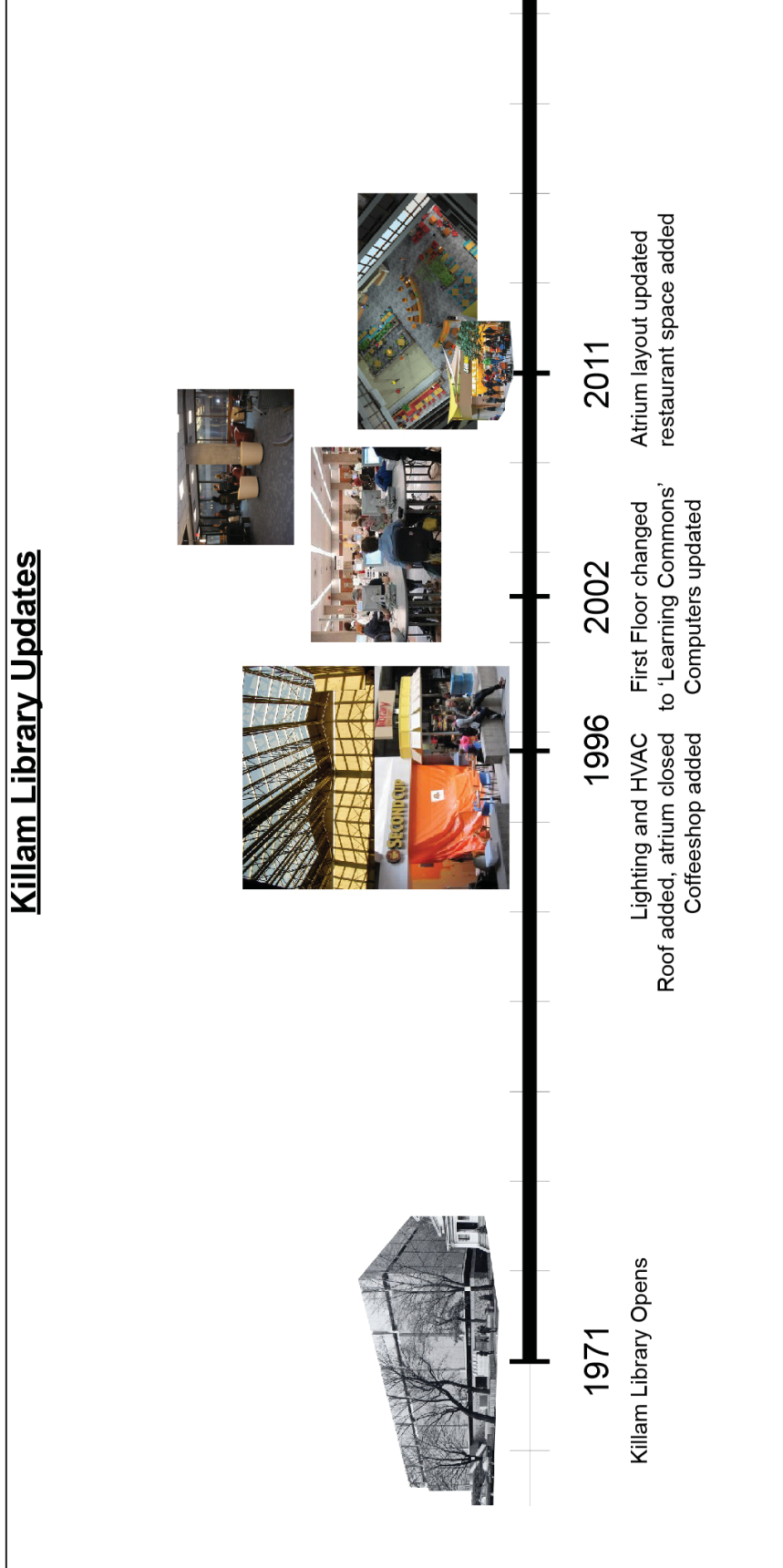

Killam Library major spatial adaptations over time

HETEROTOPIA

The space in which we live, which draws us out of ourselves, in which the erosion of our lives, our time and our history occurs, the space that claws and gnaws at us, is also, in itself, a heterogeneous space. (Foucault 1984)

The space that Foucault describes, “Heterotopia” (literally meaning “other place”), is a place outside of one’s normal everyday practice - a place where society can find not only who it is, but who it wishes to become. This condition is achieved by the inclusion of seemingly contradictory spaces in an attempt to adequately facilitate the needs of an extremely diverse public as a whole. In the case of the library, some users may prefer to study alone, in an intimate space using books, some may prefer reading on their smart phone while speeding through the city on the bus, and others in a highly collaborative environment with space for presentation and expression. By allowing for all of these diverse activities to occur simultaneously, within one environment, users are confronted with practices outside of their own everyday routines, allowing them to recognize and explore alternate ways of working and interacting.

The exploration of such a concept is important for any aspiring architect, whose eventual role as a professional is to serve the public. With new influences coming from around the world brought about by the use of new technologies, this public expands to include the globalized world in its

entirety, and the architect acting for this public must stretch and transform to represent this condition to understand and reflect it back onto the users through the spaces they design. The library becomes an important example in this discussion because it is one of the last truly public spaces available in our cities, an extremely robust typology that has persisted and adapted through millennia. With the explosion of new information technologies, new spaces emerge to be included within the library to update its physical form back into a truly heterotopic space.

CHAPTER 2: LIBRARY NOW

CONCEPTION (1960)

The concept to create a new library for Dalhousie University was initiated by a series of events that correspond to the contemporary context of the 1960s on both a global and local scale. Seen as an era of countercultures, the period of the 1960s resulted in major political reforms in civil rights, resulting in the construction of countless public institutions across the nation. These publicly funded buildings were the concrete echo of the voices of protests acting out against the establishment.

Within the university institution, Dalhousie's campus reflected global society's growing pains architecturally through the construction of three main buildings: the Dalhousie Student Union Building (1968), Dalhousie Arts Centre (1971) and the Killam Library (1971). During this period the university saw major increases in student enrollment and pushed to expand its print collection to match that of other national institutions, both of which it did not have space for at the time. This required urban and architectural scale intervention to house both the new students and new information resources. These factors led to the university determining the need for a new state-of-the-art research facility, with funds provided by a private donation from Dorothy Killam. Local architect Leslie R. Fair, former architect for Dalhousie, teamed up with

Industry Winning Pollution War
 By Stephen Kimbar
 Dalhousie Gazette P-1
 Thursday, January 18, 1968
 Number 112

SIX MILLION DOLLAR LIBRARY UNDER WAY

to be completed by summer of 1969

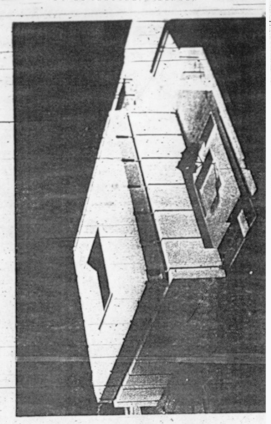

The new Killam Library, a six-million-dollar project, is under way. The building, designed by architect John C. Spence, will be completed by summer of 1969. The library will be the largest in the city and will contain over 100,000 volumes. It will also feature a large reading room and a study area. The building is located on the corner of Killam Street and University Avenue.

Vietnam Protest Can Millions Be Wro

Students in the city are protesting the war in Vietnam. They are holding demonstrations and rallies. The protesters are demanding that the government stop supporting the war. They are also demanding that the government withdraw its troops from Vietnam. The protesters are also demanding that the government provide more aid to the victims of the war.

The Black Life Under Apartheid

The Black Life Under Apartheid is a book by Walter D. Duggins. It is a collection of essays that describe the lives of Black people in South Africa under apartheid. The book is a powerful and moving work that is essential reading for anyone who is interested in the struggle for Black liberation.

A Man and his Cause

A Man and his Cause is a book by John F. Kennedy. It is a collection of speeches and addresses that Kennedy gave during his time in office. The book is a powerful and moving work that is essential reading for anyone who is interested in the life and work of John F. Kennedy.

Letter from Vietnam

Letter from Vietnam is a book by John F. Kennedy. It is a collection of letters that Kennedy wrote to his family and friends while he was in Vietnam. The book is a powerful and moving work that is essential reading for anyone who is interested in the life and work of John F. Kennedy.

Killam Library

The Killam Library is a new addition to the city's cultural and educational resources. It is a six-million-dollar project that is under way. The building, designed by architect John C. Spence, will be completed by summer of 1969. The library will be the largest in the city and will contain over 100,000 volumes. It will also feature a large reading room and a study area. The building is located on the corner of Killam Street and University Avenue.

Dalhousie Gazette
 Dalhousie University
 Halifax, N.S.
 Number 112
 Thursday, January 18, 1968

OVERCROWDING POSES PROBLEMS
 Dalhousie University
 Halifax, N.S.
 Number 112
 Thursday, January 18, 1968

Dalhousie Gazette headings from the 1960s

Ojar Biskaps, a Latvian expatriate who taught in the School of Architecture at the Nova Scotia Technical College. This partnership was a direct reflection of the current social struggle: private, institutional, local and international professional opinions collide to create a library as an offer back to its public - the students.

When faced with a totally new situation, we tend always to attach ourselves to the objects, to the flavour of the most recent past. We look at the present through a rear view mirror. We march backwards into the future. (Marshall McLuhan 1967)

As described by Marshall McLuhan in his book "The Medium is the Massage", we must not move forward by simply scrutinizing the objects of our past. We should carefully examine how the original ideologies, concretized into form, were interpreted, utilized and adapted over time by their public as time unfolds. It is through this examination of the original objects' embedded values and their evolution through use overtime that a heterotopic space can be correctly re established for the present condition. While the original design of the building had begun as a departure from the strict principles of high modernism that believed it could achieve a final solution, the emerging library signifies a complete reversal, challenging the concrete by accepting change as an inevitable condition to embrace. (Note on the Killam Memorial Library, 1974)

PHYSICAL STORAGE

While library design had shifted focus to include a civil mandate, starting in the late 1900s (Klingmann 2001), contemporary library design of the 1960s still depended primarily on the physical storage of information which at the time dictated a large part of the building's form, prior to the consideration of the consumption, application and creation of stored information. Biskaps even refers to the buildings design as a 'disk' in one of his later interviews, a metaphor that adequately describes the primary role of the library as a storage device (Maes 2004). The minimum square footage of the library was established by the existing size of the collection which had by then exceeded its current storage capacity. The new building would define a minimum floor area requirement based on the current collection while deriving additional floor area out of the available budget and height restrictions imposed by adjacent university buildings. The new building would allow for a floor area of 21,400 square meters, leaving 16,754 square meters of empty space to be filled with new acquisitions and the other activities that would be carried out within the library (Note on the Killam Memorial Library, 1974).

Today, and for the first time in the history of Dalhousie's libraries, the physical collection size appears to decrease as books become digitized. Also, the ability to track and record usage of

content becomes more precise through new technologies revealing a more clearly identifiable information metabolism. Unused knowledge is tracked through usage statistics and eventually moved off campus to eventually be recycled for other uses (Littlefair-Wallace 2013).

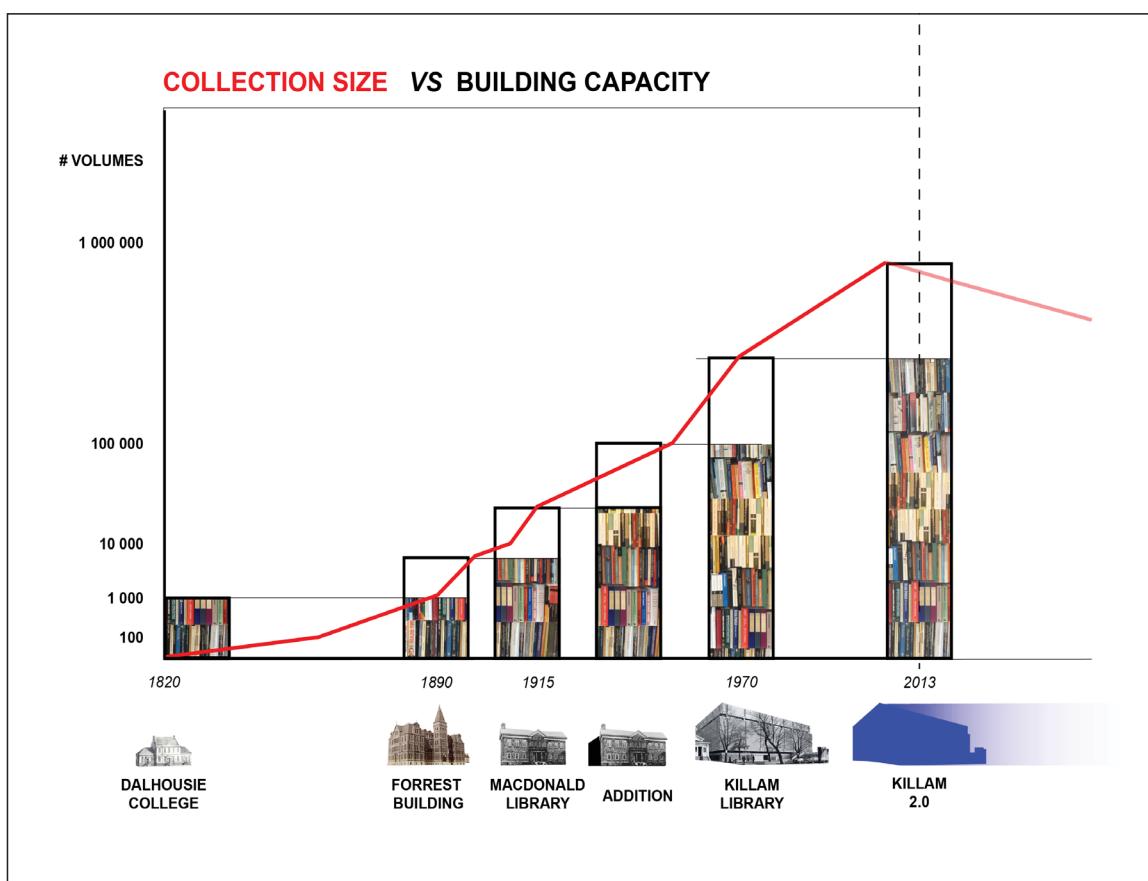

Storage duty of the library beings to disappear with digitization and recycling
(Datasource: note on Killam Memorial Library 1974)

CLOUD(Y)

Throughout the library building's life, as information technology evolves and is compressed into a new format, the condition is reversed. In the present condition, information access is not bound to a single localized space but becomes decentralized across a deterritorialized network that spans the globe.

In all its typological manifestations the library was sustained by a shared coexistence of two diachronic programs within one territory: Hence, the moment of the contemporary library is critical, because the conditional accord of both programs information storage and information transfer has ceased to exist. (Klingmann 2001)

Various modern library designs imagine the "bookless library" - a full virtual conversion into "the cloud". This position fails to recognize that the virtual world is fully reliant upon a very physical infrastructure that spans the globe, built up by a network of underwater fibre optic cables, data centres and exchanges. The repression of the physicality of the Internet creates an aura of ease that clouds the fact that, while its virtual counterpart is perceived as limitless, it is intrinsically bound to a geography with its own political rules and restrictions that begin to impose limitations on the seemingly endless virtual space (Blum 2012, 230). These geopolitical restrictions have become increasingly apparent in light of recent revelations by whistle blowers, detailing massive surveillance systems that monitor and store the actions of Internet users worldwide.

While the formats may change from the book to the disk, information is still very physical. To increase accessibility information moves one step further from direct human interpretation, requiring handheld technologies to mediate the gap for interpretation. For ease of use, society has willingly transferred the direct power it had over the existing format and redistributed it amongst a host of new private participants, including, but not limited to, Facebook, Google and Amazon. While these companies appear to be operating for the public's best interest, they also comply with private government operations to gather and record actions on an unprecedented scale. This is best characterized by Google's internal slogan "Don't be Evil" A constant reminder of the power and influence that they have (Assange 2013).

The oversight process of the United States National Security Agency has recently come under immense international scrutiny over the PRISM surveillance program it started in 2008 where massive amounts of data including voice, text, and video, from around the world are recorded from the Internet and stored for analysis. As a society we should consider the implications of divulging this information to a third party and consider the storage and maintenance of our own systems. Instead of imagining the Internet as a cloud, its physical presence must be revealed and reinstated to allow the public to understand their environment in a more complete way.

In the most recent campus plan, Dalhousie's own data centre, currently located in the basement of the Killam Library, makes its first appearance in the campus plan since its debut in the original construction of the building. In its beginning, the purpose of this space was to experiment with emerging and cumbersome computer technologies, to prepare for and further explore the imminent digital conversion, empty conduits were included to service all areas of the building for future connectivity. In the present, its role has expanded to service not only the building, but the entire campus - making use of the campus' infrastructural spine below University Avenue containing the centralized steam system. Each building in the campus now receives its own high-speed fibre line terminating in wireless nodes similar to nerve endings. The result is an environment where we are constantly connected to the virtual world via our smart phones and laptops.

While information formats may change, now being accessed within the virtual space of the Internet, the information we use to further expand our knowledge is still inherently physical, requiring space and energy to function. In the updated library scheme physical information becomes reinstated into the libraries architectural design to correct the public misconception and increase awareness of important societal issues surrounding information storage knowledge and power.

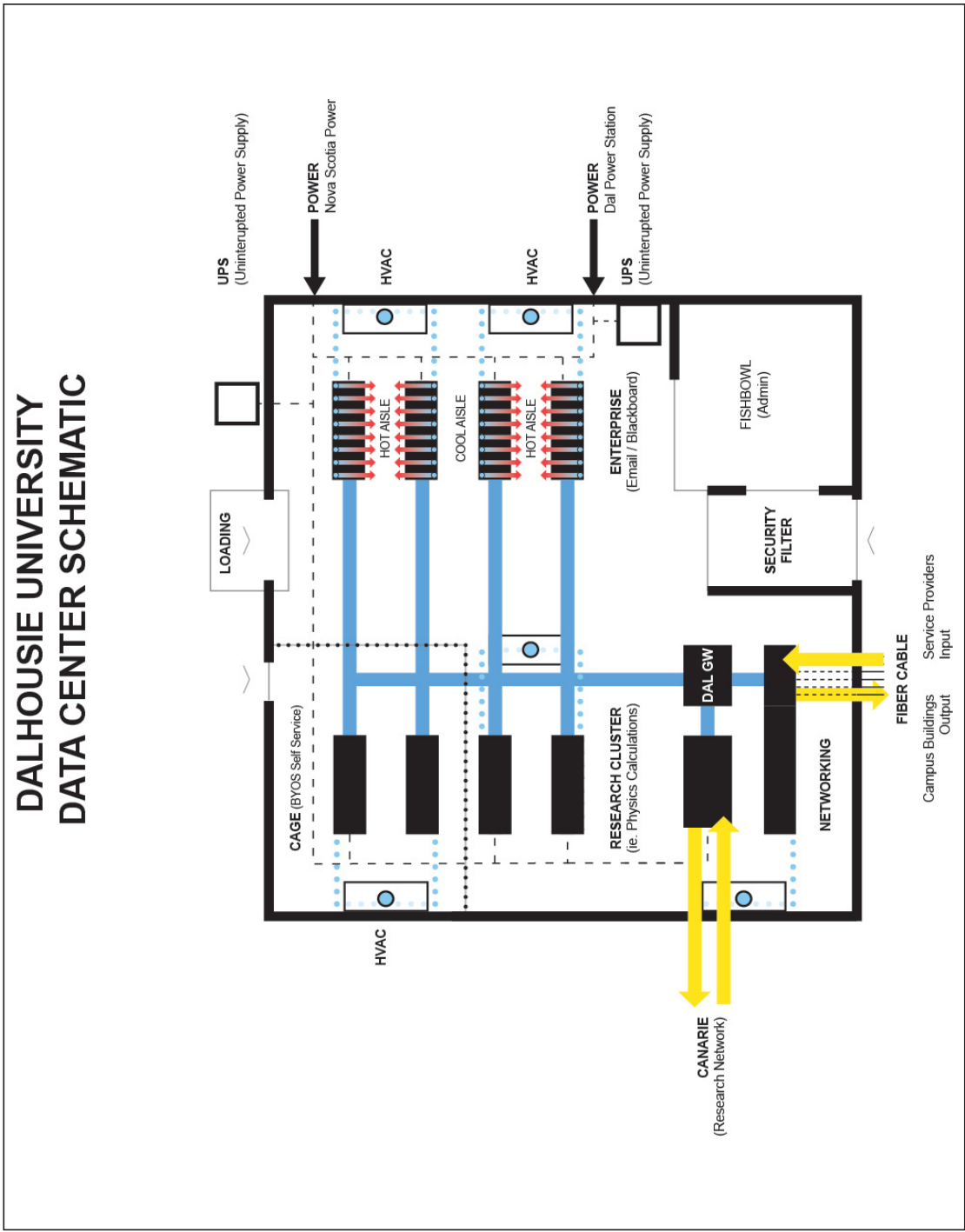

Schematic diagram of Dalhousie's data centre, produced after tour of premises

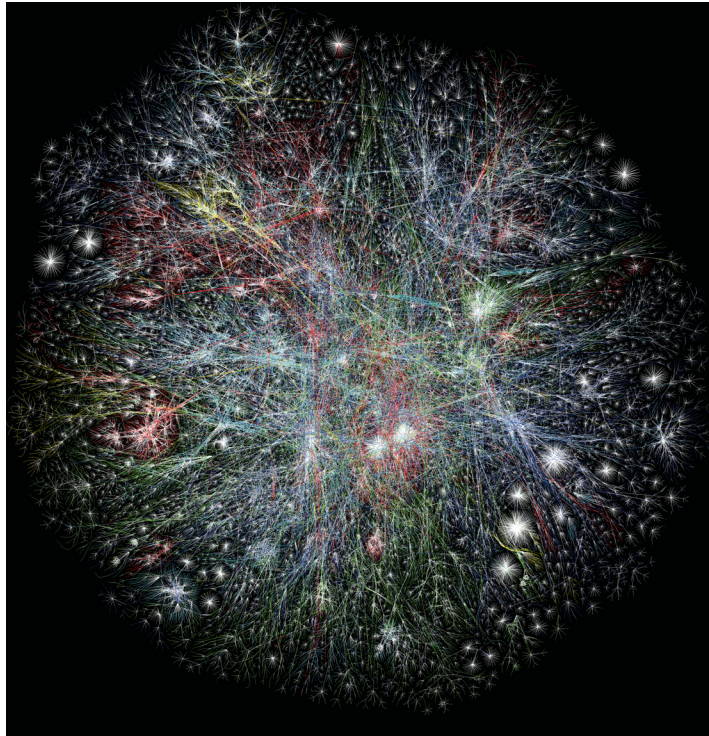

Map of the Internet's virtual connections (Internet map, Barrett Lyon. Wikipedia)

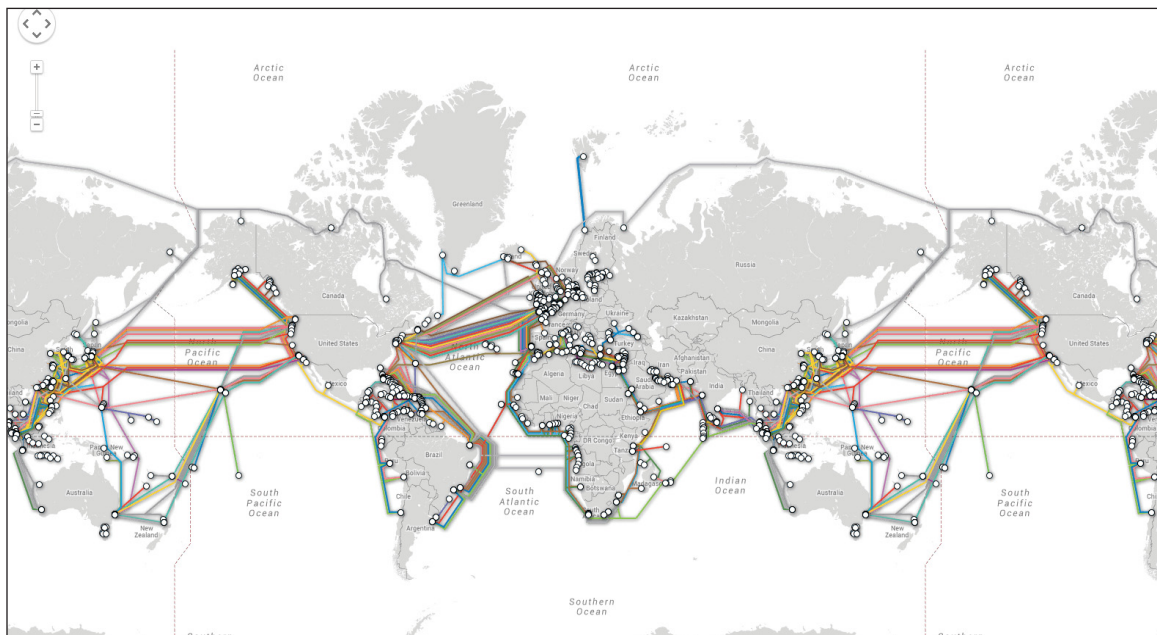

Map of the Internet's physical underwater cable systems (PriMetrica, Inc. 2013)

CHAPTER 3: DESIGN

INFORMATION CORE

...the idea of accumulating everything, of establishing a sort of general archive, the will to enclose in one place all times, all epochs, all forms, all tastes, the idea of constituting a place of all times that is itself outside of time and inaccessible to its ravages, the project of organizing in this way a sort of perpetual and indefinite accumulation of time in an immobile place, this whole idea belongs to our modernity. (Foucault 1984)

To reconstitute the physicality of the current information trend, all formats currently in use: maps, books, music, video, serials and electronic resources - become consolidated into an information tower, The Information Core. Information is now organized and delivered via a network of machines that constantly operate to reorganize the information within and deliver it to users in any organization imaginable - not restricting the user to a topic based organization system such as the Dewey Decimal or Library of Congress Classification systems used in today's libraries. While the tower delivers information it also acts as a vault to keep the objects safe from the constant erosion over time. To achieve this feat, the tower is clad in a specialized military-strength glass composite that controls light, air, and humidity within, containing solar cells to power the device; the resulting surface is a dark mirrored facade.

While the new tower facilitates the accelerated exploration of our deepest dreams and desires

through its ability to produce new spatial organizations of information, this comes with a drawback. Users of the core must wait for the machines to assemble the information they have summoned into the desired organization. While the students wait, they gaze into the mirrored facade; an intensified moment of self-reflection occurs preceding information consumption. The information is then revealed as the mirrored glass slides away to reveal the personally tailored rack(s). When users are finished pillaging, referencing, rejecting and consuming the information, the rack is left in place to be seen by the casual passerby. This reintroduces the serendipitous experience of stumbling upon library materials but does not limit the experience to a fixed, topical, organization. Instead users within the library pass by information being summoned by the public collective, revealing the most current desires of the whole. This spatial experience aims to achieve a physical experience similar to the individual experience experienced individually online. This method of display is similar to how content is consumed on Facebook and Twitter feeds. Users visiting these sites are confronted first by the most recent content and content trending by geographical location. This enables the user to see information as it occurs in real time, and to see topics that other users are interested in.

VERTICAL ACCELERATION

The Information Core also houses the library's elevator shafts, allowing users to access various levels of the library's study ring at accelerated speeds, bypassing the stairs and potential interactive distractions with other users. While the core itself cannot be entered by humans, a glimpse of its inner workings can be observed while inside the elevator. Silhouettes of the operating machines and the structural racks that hold content within can be observed faintly through the reflective glass enclosure.

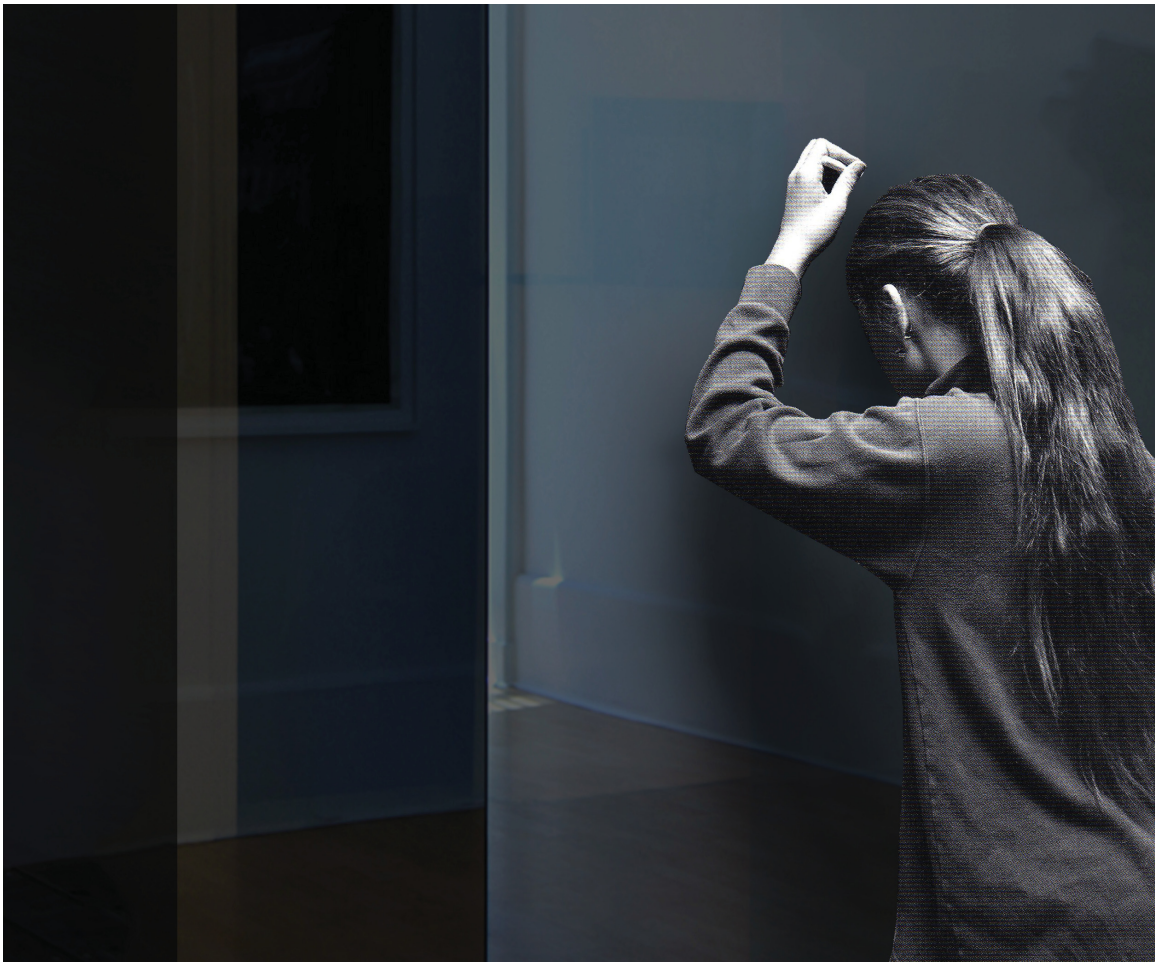

The surface of The Core obscures the interior contents, offering moments of self-reflection.



Section showing the corner of the Information Core, structure and human interface

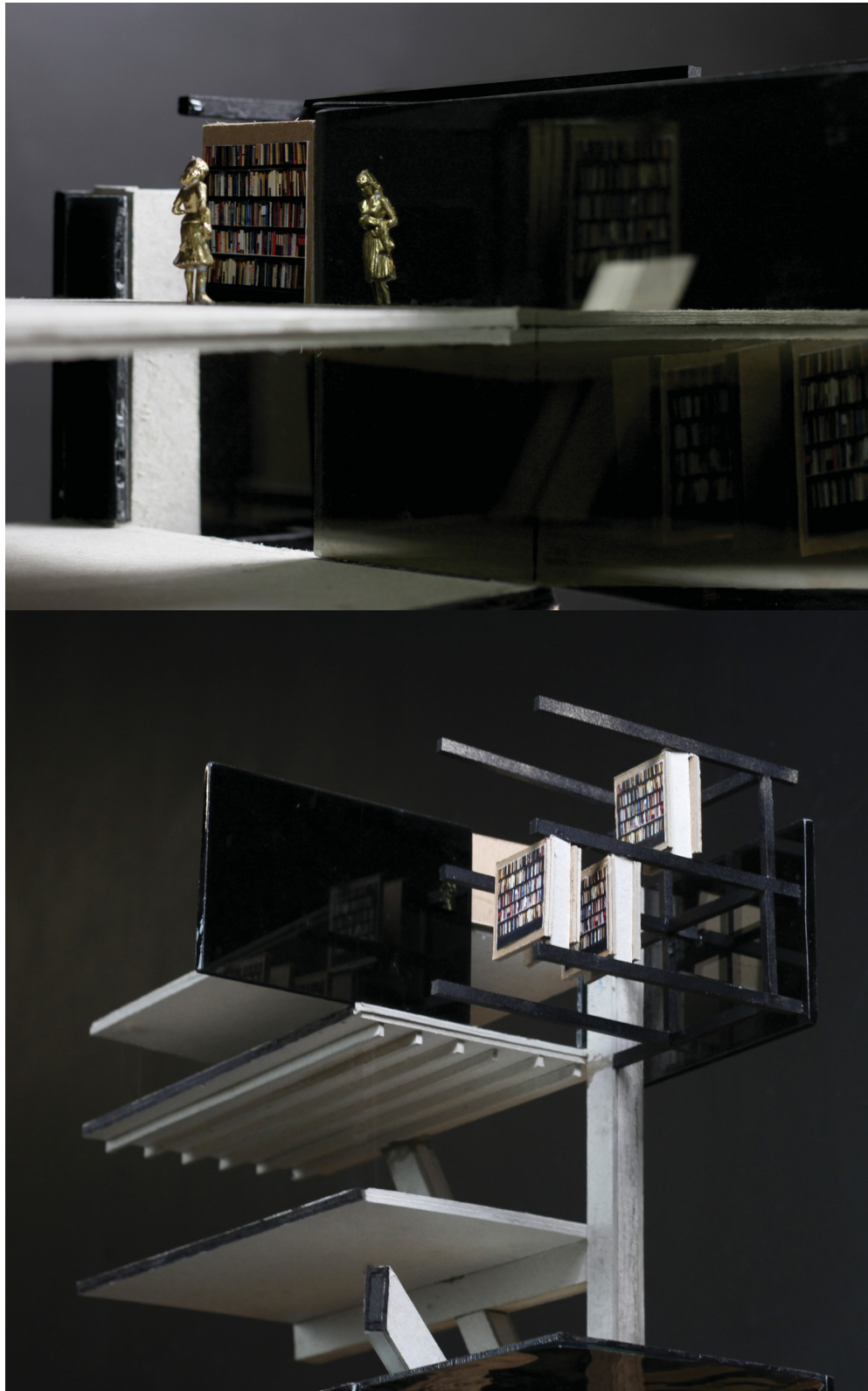

Section showing the corner of the Information Core, structure and human interface

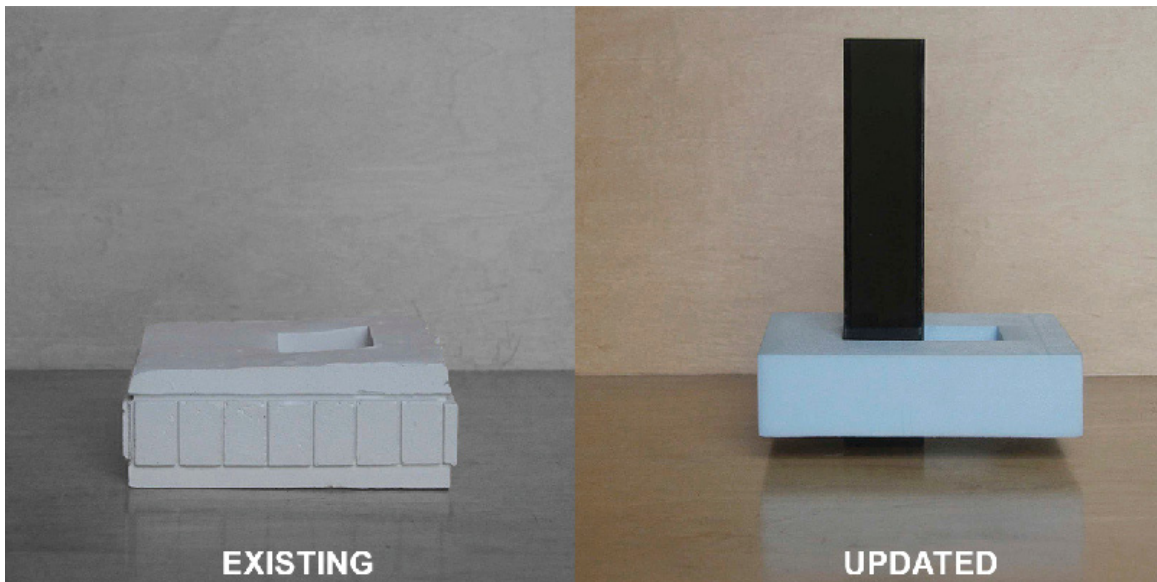

Physical storage placed adjacent to atrium void space

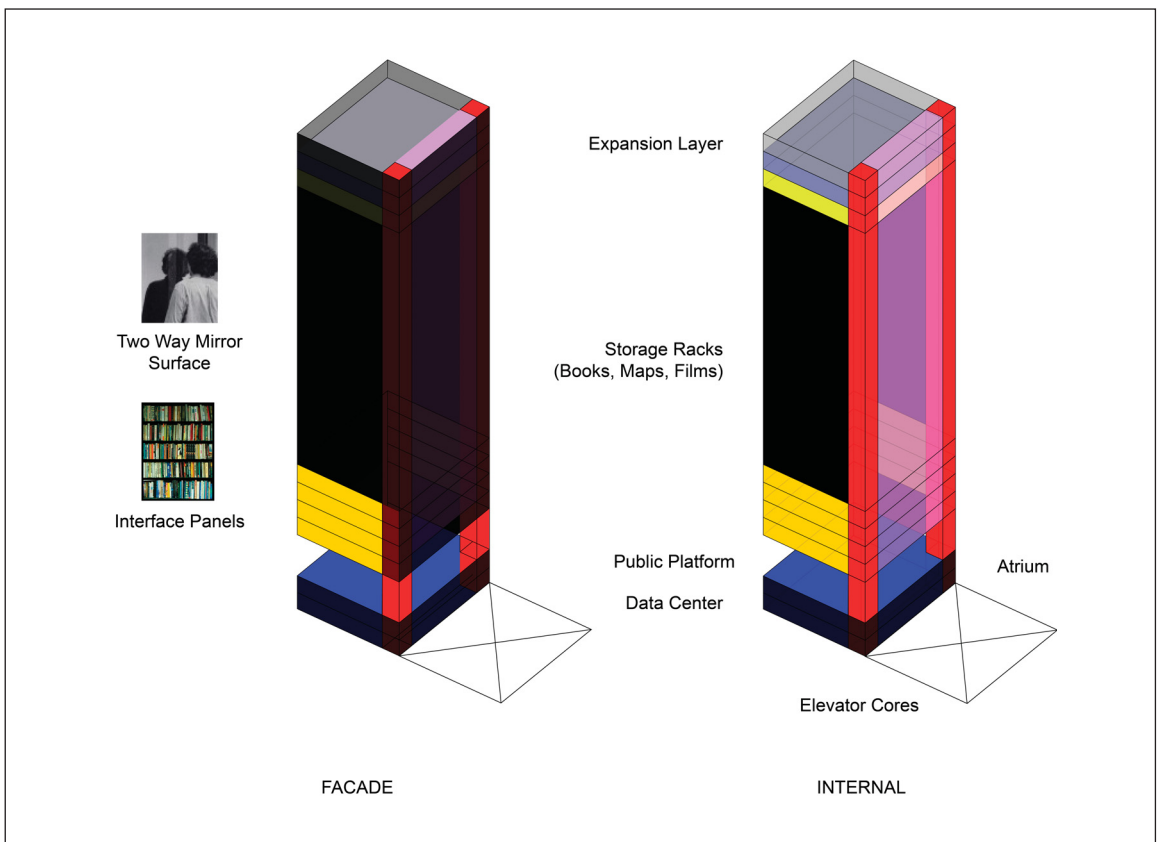

External interface / internal layout



The preserved storage vault, discovered by a future civilization (base photograph from New York times)

EXPANSION LAYER

If users choose, they can elevate to the highest level of the tower, the “Expansion Layer” where the inner structure is revealed once again, awaiting the construction of additional levels for increased information storage capacity.

The Expansion Layer is situated at the current, but constantly shifting, summit of the information tower provides unprecedented views of the surrounding city and its various networks operating below (to the northeast) and the vast Atlantic Ocean in the distance (to the east). While users at this height have a unique perspective of their surroundings, achieved by the vertical accumulation of knowledge, at such a height they become physically disconnected from where actions are being carried out below in the city of Halifax and globalized world at large, external to the Dalhousie institution.

While this space offers a contemplative space for isolation far above the distant world below, an additional space must act in opposition to this space to intensify connection to the physical world where thought can be translated to action more effectively.

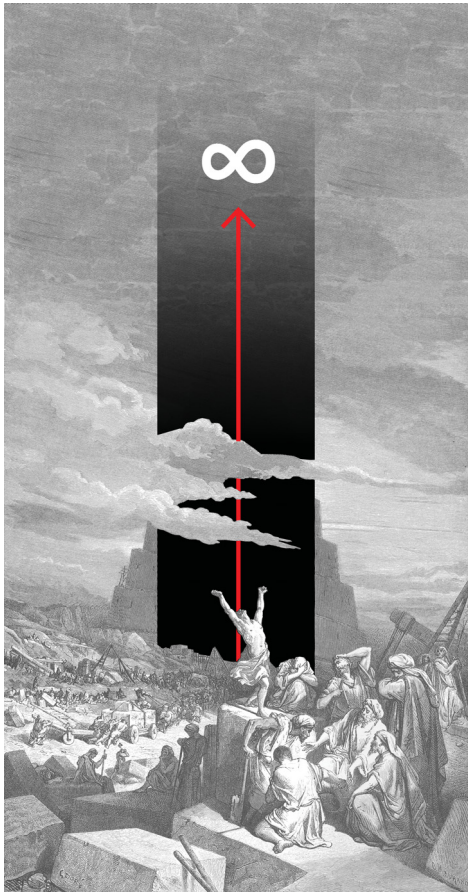

The Tower expands and contracts according to its contents



View from the Expansion Layer, seeing oneself in relation to the city's networks below

DATA CENTRE

In the opening statement for CLOG Issue 'Data Space' editor Kyle May raises the importance of the data centre to the 21st century as the physical requirement for our increased virtual activities. He asks, "What is the significance of this bridge between the virtual and the physical? How does this new typology affect the discourse of architecture and the shaping of our built environment?" (May 2012a)

While we increasingly store our digital information out of sight and mind, the library building type follows suit by imagining the "bookless virtual library" clearly expressing society's willingness to divulge our virtual selves to third-party private corporations for storage and maintenance. To realign the library type with the realities of the contemporary condition, storage of public data becomes absorbed into the existing typology to emphasize both the importance of our actions in the virtual world and the importance of who keeps that stored information maintained and safe and where this occurs.

The physical manifestation of the data centre presents an interesting contradiction. While its presence facilitates the use of a seemingly limitless virtual space that allows unprecedented access to equal knowledge, its physical manifestation is exactly the opposite: a secure non-descriptive mass out of bounds to the public that it provides for. This sharp contrast displays

the disconnection between the physicality and virtuality of the Internet. To represent this split personality architecturally, the data centre becomes a public platform. A space in the core is opened to reveal its primary structural components that act to suspend the stored knowledge above. This places the user in the centre of this condition where trust must be instilled in the institution to uphold its promise to safely secure the physical knowledge and personal information of the library users. On this platform important debates are carried out as to how information is accessed and what information is made available for public use.



Data centre technicians maintain the machines holding private data while the public operates on the public square above

NEW(EST) NATURE

...all the other real arrangements that can be found in society are at one and the same time represented, challenged and overturned: a sort of place that lies outside all places and yet is actually localizable. (Foucault 1984)

In 1993, the Killam Library experienced its first drastic physical change, greatly altering the architecture's original intentions. The exterior void, extracted from the centre of the library, acted as a decompression chamber to bring in natural light. In this configuration the architecture framed nature to establish a sublime experience upon entry, allowing the user to undress from the exterior world. Because of intense wind pressure created by the openings, the space became highly undesirable and needed to be dealt with (Riggs 2005). The most direct solution involved capping the atrium, reclaiming the exterior as interior space, further controlling the surrounding nature. A coffee shop and snack bar were added in conjunction with the closure, reversing the library's former "No Food / No Drink" policy that preserved the collection within since the libraries creation. With the proliferation of emerging formats, the university began to shed its dependence on the format of the book, allowing it to be used in different spatial and social conditions. With the rise of the Internet, cafes emerged as a new territory of shared information consumption, allowing users to connect into the virtual network while consuming caffeine in a "see and be seen" atmosphere. While recent

library designs reject the inclusion of corporate or private enterprise, carefully organizing their influence to funding the project (Klingmann 2001), rather than direct interaction within the public space, it must be recognized as a new social practice that has been adopted and should be represented spatially. While the library serves as one of the last bastions for public activity, this activity now includes the consumption of goods that often come from private and international sources in a highly globalized world. One could argue that with the amount of voter turnout displaying a loss of confidence in our current political model, the consumption of goods becomes a new form of voting or describing ones own values. Western society now operates fiscally rather than politically. The added retail units become implanted into the libraries updated design and granted more presence, forming the new programmatic foundation of the building bordering the existing atrium space, now excavated down one level. Retail units are chosen through digital democratic voting of the university population facilitated by computers within the information core. A unit's continued life depends on its ability to correspond, adapt and serve its users and can be filled by either a multinational or local operator.

MACHINE SYSTEM

Automation as been fully accepted as the new way forward with library systems. While the embracing of the machine is currently used to speed up the process and accuracy of returning books, automation can be taken a step further to re organizing the actual content itself for both display and access.

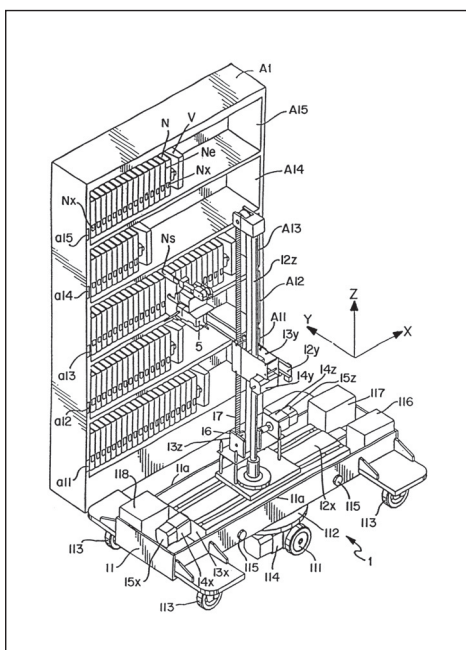

Automated Library System With Retrieving And Respositing Robot (Kanazawa Institute Of Technology 2001)

A sorting machine such as the one represented in PATENT US6535790B2, a patent for an “Automated Library System With Retrieving and Respositing Robot” can be used to continuously shuffle information throughout the library and distribute it out to the users of the library in a myriad of organizations and in different spatial organizations.

In his essay “On Constructing Realities” Von Forester, believed by many to be the grandfather of cybernetics states that, “The Ethical Imperative: [is to] Act always so as to increase the number of choices (Von Forester 1973).

Technology should always be operating to create more options for its users, not to restrict them. With these new systems available, the library can innovate to transform the ways in which we retrieve and find material allowing for new connections and relationships to be discovered. With digital content now being intrinsically linked to a growing assortment of metadata, possible organizations and relationships multiply.

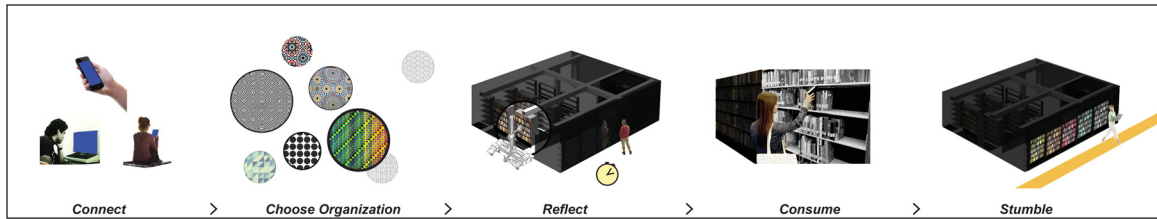

Diagram showing the interaction with the Information Core for information extraction

However, because this digital information is inherently physical, stored within the data center, the remaining collection, still existing in printed format transforms accordingly to allow it to be accessed and consumed in a manner similar to the new virtual tools that are available at our disposal but in a physical spatial arrangement. The public procession spiraling up through the library around its inner perimeter, becomes populated with movement and activity displaying to the casual passerby recently accessed content to be displayed, stumbled upon, and possibly consumed.

The possibilities of such a device begin to suggest exciting uses. On important dates pertaining to certain historical / local events content can be extracted from the core organized into a rack and displayed on the main level where the most people will pass by, making them aware of the event and allowing them to access content directly pertaining to it. Students can summon an organization according to a specific author, while including books that past patrons took out along with the first, similar to Amazon's "Customers Who Bought This Item Also Bought..." upselling

device. In this instance this specific organization technique can be used to make users aware of linked content and other potential faculties who are using the book - possibly providing them with a new perspective on material pertaining to their own fascinations in a spatial configuration. With a full digitization of text, users will be able to organize racks down to the word, locating information with a new level precision (using tools such as Google's ngram viewer).

While automation has found its place within contemporary library, it must expand its use to organization information in a direct relationship with the user in order to reconstitute the physicality of information by introducing virtual information organizations into the physical world.

ESTABLISHING A NEW PLANE

In early 2011, the LINC (Learning Incubator Networking Classroom) was added to the second floor of the Killam Library, replacing an area previously used for scientific journal storage. This space, in accordance with the 2010 master plan, is to establish a "learning commons" that "will be designed to foster social interaction and interdisciplinary group study supported by state-of-the-art information technology systems." (IBI Group 2010) While the idea of the space is embedded in the conversion, the only real spatial change that occurs is the addition of new drywall, carpet, furniture, screens and power



Inclusion and segregation of consumption below the plane

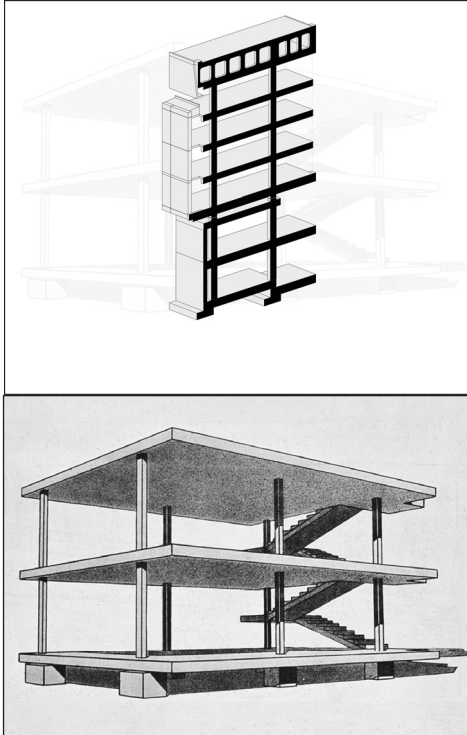

Library's primary structure not dependent on facade freeing it for architectural for adaptation (Wikimedia Foundation 2013)

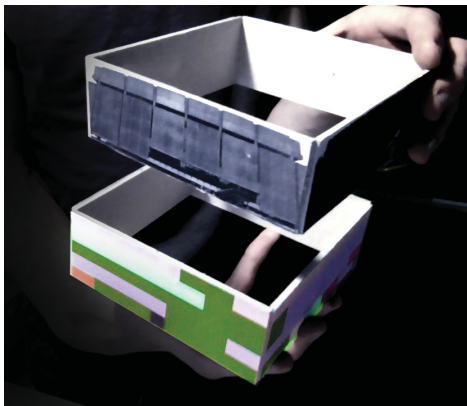

Facade opened to establish a dialogue between inside and outside

outlets, which act to further enclose the space and restrict the social interaction that the space seeks to achieve. The idea for this revolutionary new space is still heavily defined by the existing architecture implemented in 1972, contained by the large precast concrete panels that hang off its structure.

In the updated library scheme, because information is now consolidated into an expandable tower, the remaining floor space is free to serve as a platform for emerging programmatic configurations. To continue the ongoing initiatives within the library and also provide a collaborative study space separate from the consumption of goods on the basement level, a new plane is established above the first to serve as a space for transitory study and increased academic interactions, offering views to the consumption study space within the food court below. This new plane breaches the existing facade to open views to the campus quad and University Avenue, infusing the space with a sense of connection and movement from the surrounding context, 360 degrees around the entire building.

To further intensify academic mixing within the Killam Library, a visual connection is established with the surrounding campus and its public quad acting as a backdrop to infuse the newly established public plane with visual connections to activity.

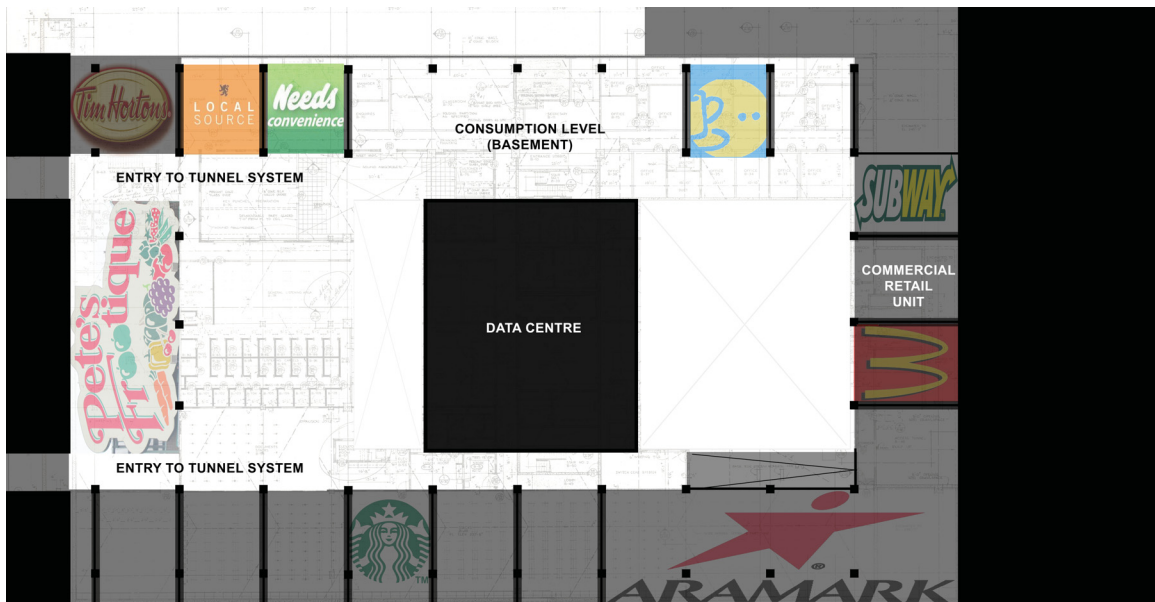

Diagrammatic basement plan showing opened connection into tunnel network

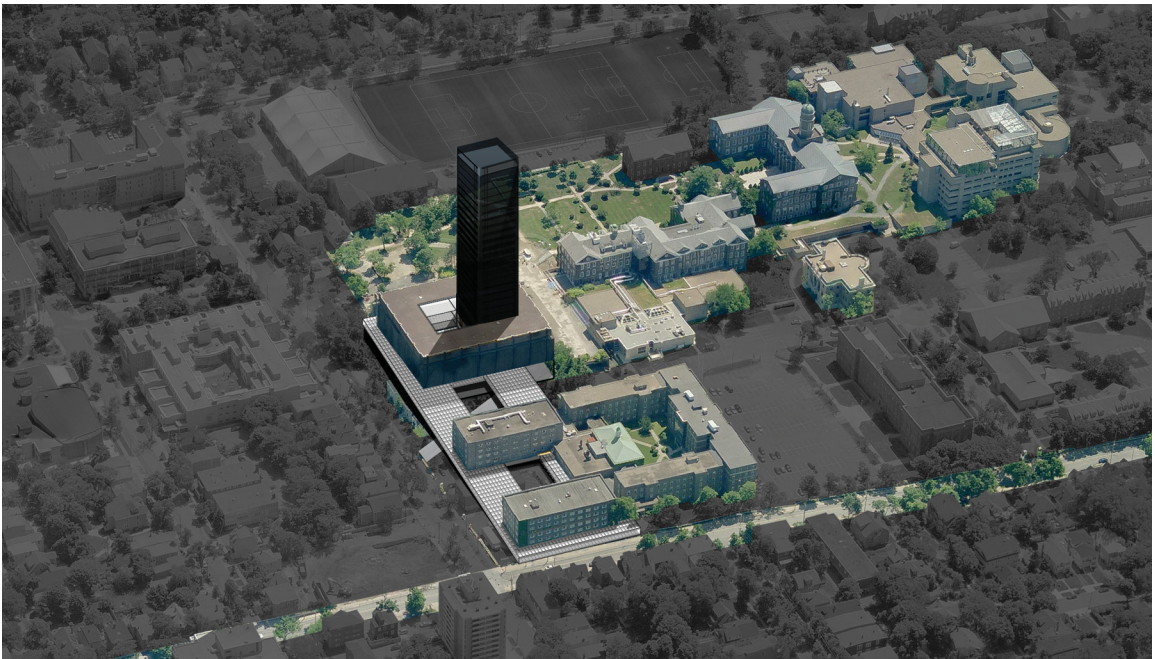

Library connects with underground tunnel network to establish physical network (aerial from Bing Maps)

EXTENSION, THE CONVEYOR

The connection to context is further intensified architecturally by extending the communal study plane of the second floor north of the existing library towards the shared edge between the institutional city of Dalhousie and the adjacent external city of Halifax along Coburg Road. Just past this point to the west this edge turns into Spring Garden Road, one of Halifax's defining axis that forms the spine of the city's central shopping district.

Through this extension the conveyor intersects two wings of Dalhousie's Howe Halle residence linking it into the physical network of the library. At the intersections along the west edge, students can enter the existing student dining room within or pass directly into the residence's main lobby.

The extrusion of the second story plane creates additional study spaces in a more informal setting, joining intensified physical movement exchange with study resulting in a interstitial transitory zones similar those found along an airport terminal. Overtime small kiosks can be implemented within the existing structure to facilitate new and unforeseen needs discovered by the students.

Travelling along The Conveyor, students can drop their bags and make use of the study spaces found along the periphery of the plane, facing the traffic along Lemarchant Street or inwards,

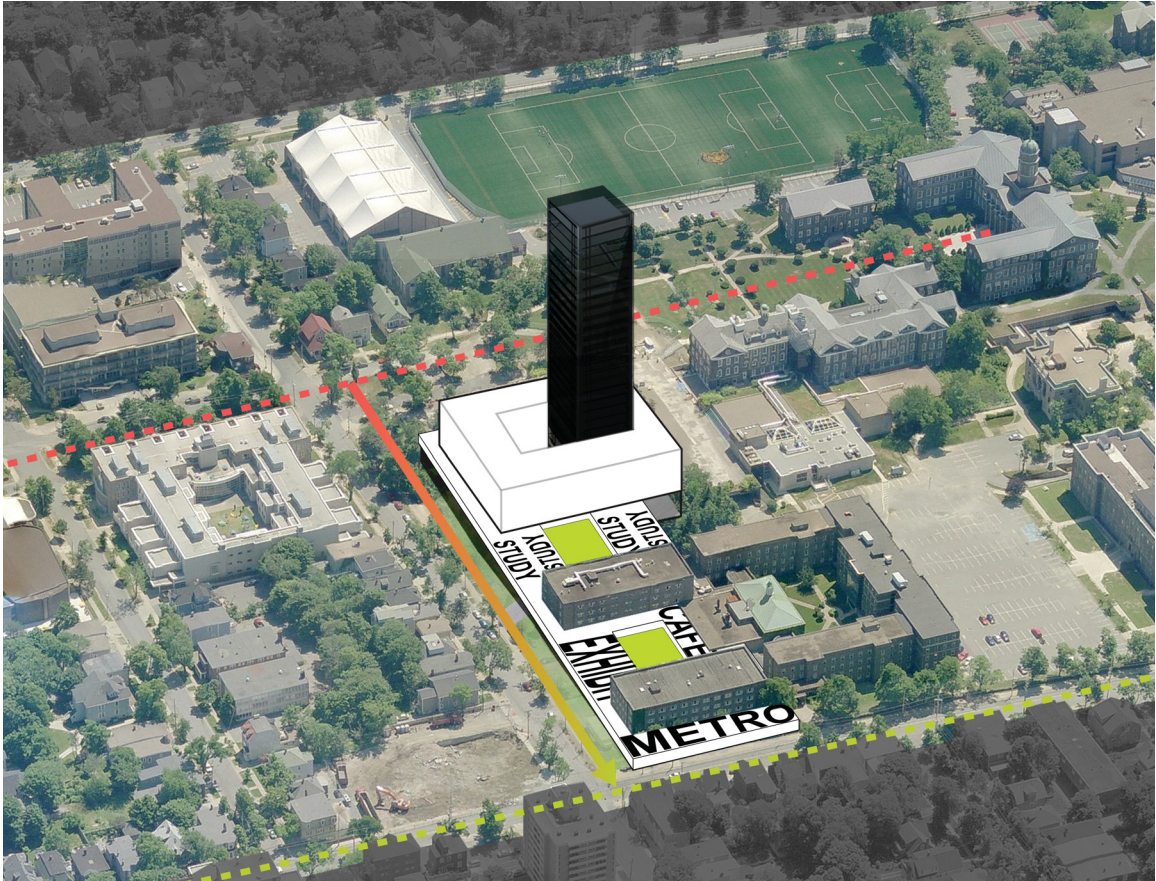

Connection between library and city showing program

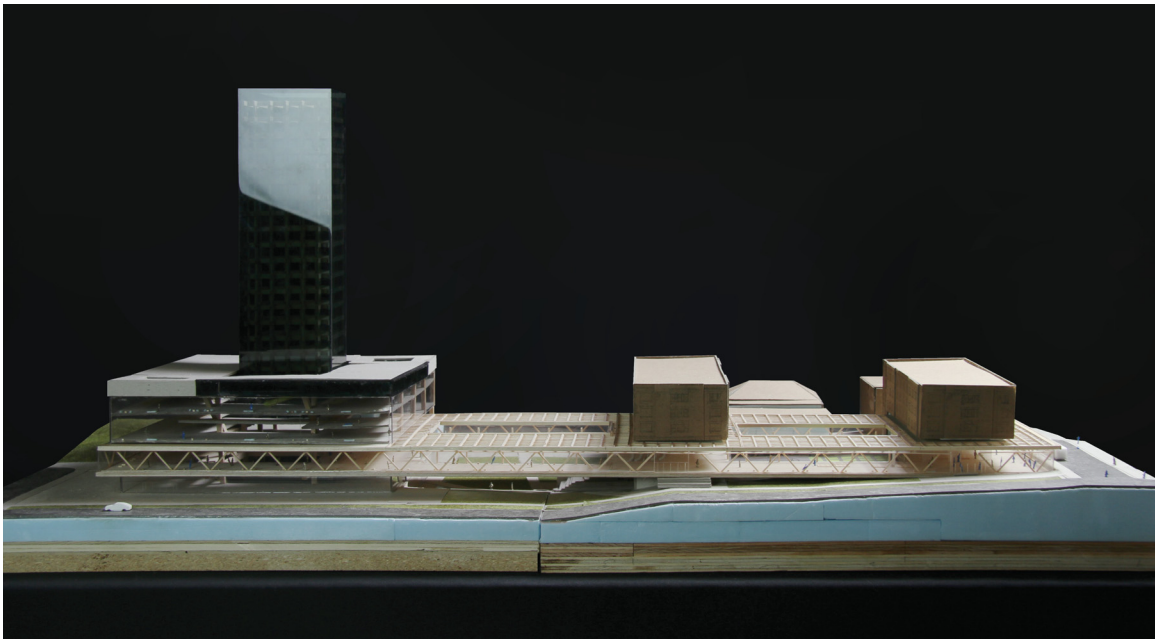

Conveyor, library adapts to connect university to adjacent city, 1:200 model

facing two courtyard spaces with gardens within. The conveyor becomes the horizontal equivalent of the existing vertical atrium space of the library, providing the condition of seeing and being seen, important to establishing a community study environment. In this way the conveyor becomes a sort of fashion styled catwalk, a place for people watching, social collisions and rendezvous.

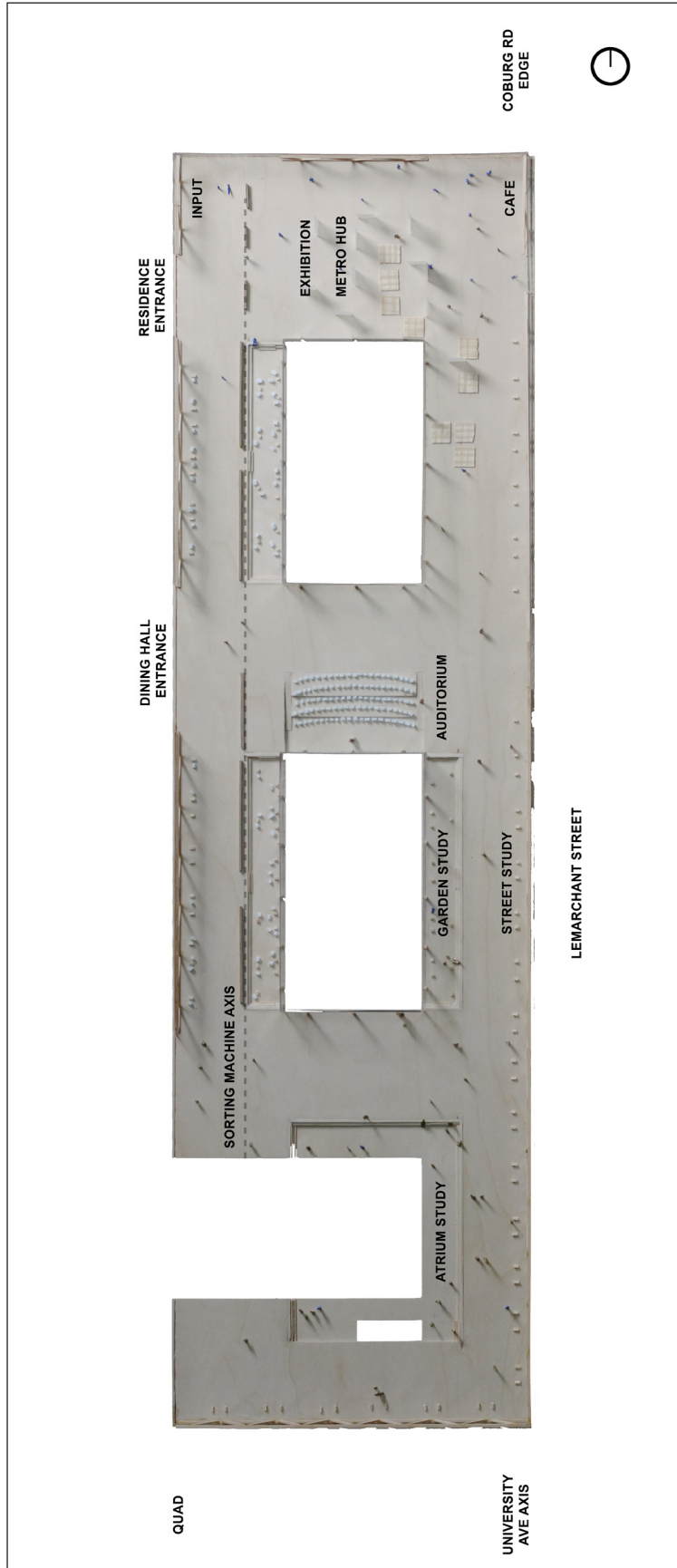

Plan view of The Conveyor

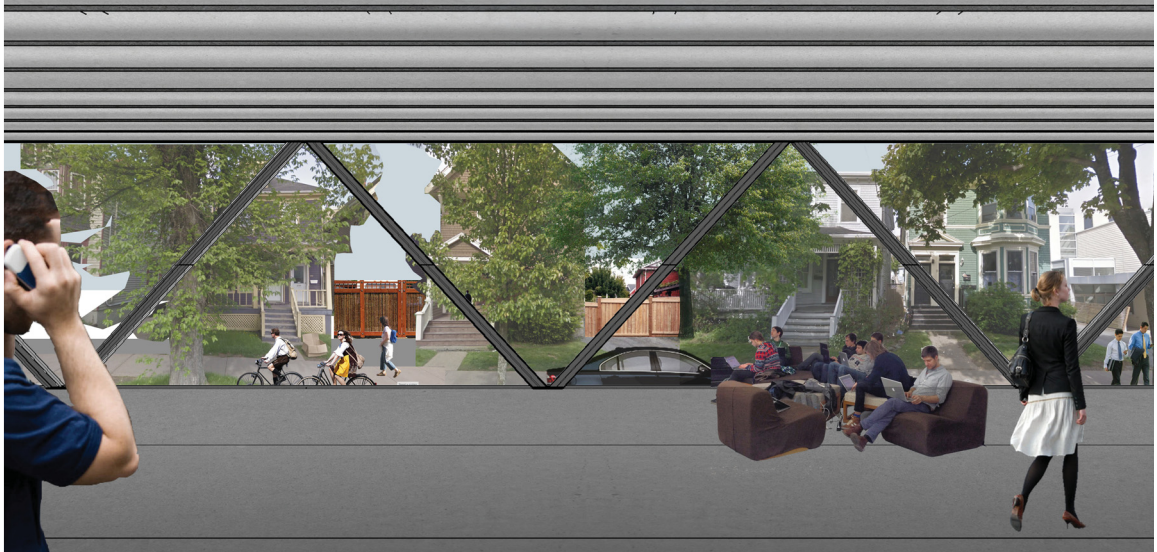

Street study, facing Lemarchant Street

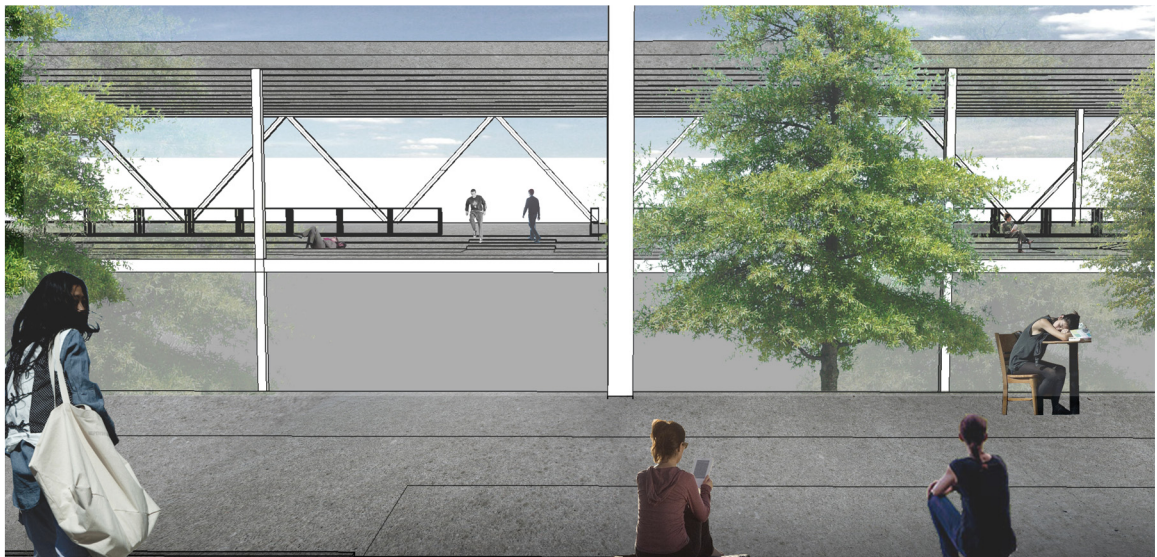

Garden study spaces, facing the interior courtyards



Sectional model showing The Conveyor structure and garden study wing



Plan view framing the tip of The Conveyor, exhibition space blends with newly positioned metro hub



Section through the tip of The Conveyor, displaying the blending of activities



Detail showing exhibition space blended with metro waiting area



Detail, garden-facing study space, with sorting machine axis behind



Detail, study bar connects the edge of the metro hub to the loading area



Elevation of The Conveyor north facade showing the edge between Dalhousie University and the city of Halifax facing Coburg Road,

INFORMATION LOOP

Through this extension, the defining vertical and horizontal elements of the updated library connect to outline the path of an information loop that manages the exchange of knowledge between the university campus and the city of Halifax, acting as multi-directional gateway. From the shared edge between Halifax and Dalhousie, new physical acquisitions enter the conveyor by delivery truck into a digitization kiosk located at the far north west corner of the conveyor. From here content is loaded onto the sorting book shelf axis, put on display to users passing through the conveyor on their way towards the university's center or back out towards the surrounding city of Halifax. Content is pushed along this axis by a continual resorting achieved by the machines, constantly moving newly added material along the horizontal plane as more content is added to the system. This establishes a physical spatial condition similar to the experience of consuming content online, within the virtual world of the Internet, where the most recent content is displayed first. This is similar to the organization of current social media feeds such as Facebook, Twitter and Tumblr. When the pushed content meets the Information Core it is brought vertically up and into the vault for safe storage on the racks within.

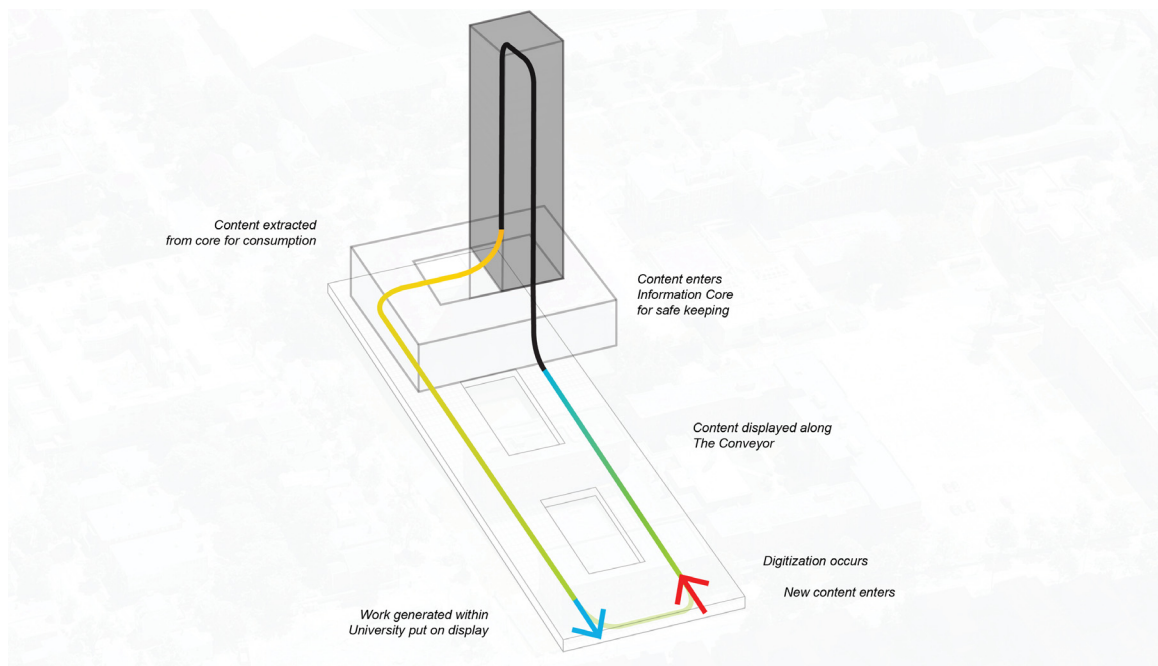

Information loop diagram



Information loop diagram, in relation to 1:200 model

An auditorium, situated in the centre of the conveyor, manages the flow of knowledge held in human format by way of visiting academics and practitioners. From this point, visitors, or those returning from experiences abroad, outside of the institution, can transfer their knowledge to the student body in a central, highly trafficked, location. When not in use the stepped seating of the auditorium becomes a lounge space that continues down into the courtyard below connected by a public stair. With large operable doors this space can be opened up in the summertime to create a seamless flow between the garden study space and the conveyor plane.



View across the courtyard space towards The Conveyor auditorium

The conveyor terminates with a programmatic blending between a new exhibition space and repositioned main metro hub servicing the University Campus. This space Creates an intensified physical connection to the city of Halifax and its physical networks, connecting to the international airport and the rest of the world. While students wait for transit to arrive they can use their time to browse ongoing research happening within the university between the various faculties, or travelling exhibitions from other research institutions abroad.

The newly established information loop, defined by The Conveyor and its various programs, aligns the flow of information with the flow of library users to create a unique spatial experience with physical content that better reflects the realities contemporary practice.



A view through The Conveyor exhibition space towards the shared edge between Dalhousie University and the city of Halifax

STUDY RING

With physical information now consolidated into the expanding Information Core, the remaining floor space of the existing library above The Conveyor is free to be reconfigured for the access, consumption and creation of knowledge rather than being defined primarily for the storage of information. To redistribute these actions across the reclaimed area, the building's surrounding context is used to program the space within - acting as a backdrop. The facade is manipulated to display the actions happening within and establish a visual dialogue with the library's surroundings.

Collaborative study is situated to the south and the east on the lower floors to create visual connections to the adjacent major transportation routes, the university's main axis and Lemarchant Street. On the upper floor, collaborative study space flips sides to offer a visual connection to the city of Halifax in the distance.

Conversely, the isolated study zones are situated to the north and west on the lower floors to face the quiet garden and facade of the adjacent Chemistry Building, establishing a more inward environment with the surroundings as a backdrop. On the upper floor, isolated study space flips sides to offer visual connection to the Northwest Arm and Atlantic Ocean in the distance.

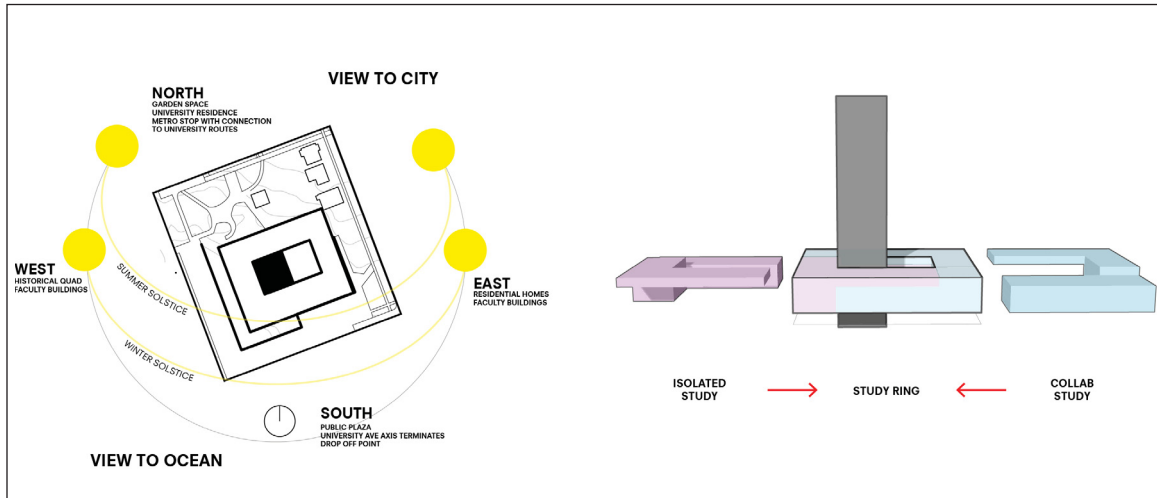

Study Ring program reconfigured



Study Ring opened up, introducing natural light and infusing the space with the surrounding context (aerial photograph from Bing Maps)

In this configuration transparency and access to light is achieved while still providing both inward study environment and collaboratively study environment. The library establishes a connection with its surroundings by using its external influence as an interior facade.



1:200 model with 24 hour access areas illuminated

ISOLATION GARDENS

In an attempt to contain everything within its interior space, the original library's skin took on the form of fortress, rejecting its immediate context to establish a space for inward focus (Maes 2004). This was accomplished through the building's exterior facade of hanging precast concrete panels that fully deny entry of both light and sound onto the users within. With the conditions of the time, distraction is effectively thwarted, simultaneously concealing and controlling the actions of the students studying within.

The most recent library quality survey (Bedwell 2013) identifies the continued importance of the library as a getaway from the distractions of our personally constructed places of retreat. The majority of students who completed the open-ended comments section at the end of the survey described the library and its computer systems as a way to escape the distractions of their everyday routines to focus on their academic pursuits. School computer terminals are used to avoid social media distractions that users would be inclined to access on their own systems. It appears as if the very nature of distraction itself has changed, as we are now constantly connected to the Internet through our handheld devices, constituting the need for a new contemplative space.



The Isolation Gardens, section along outer edge looking in

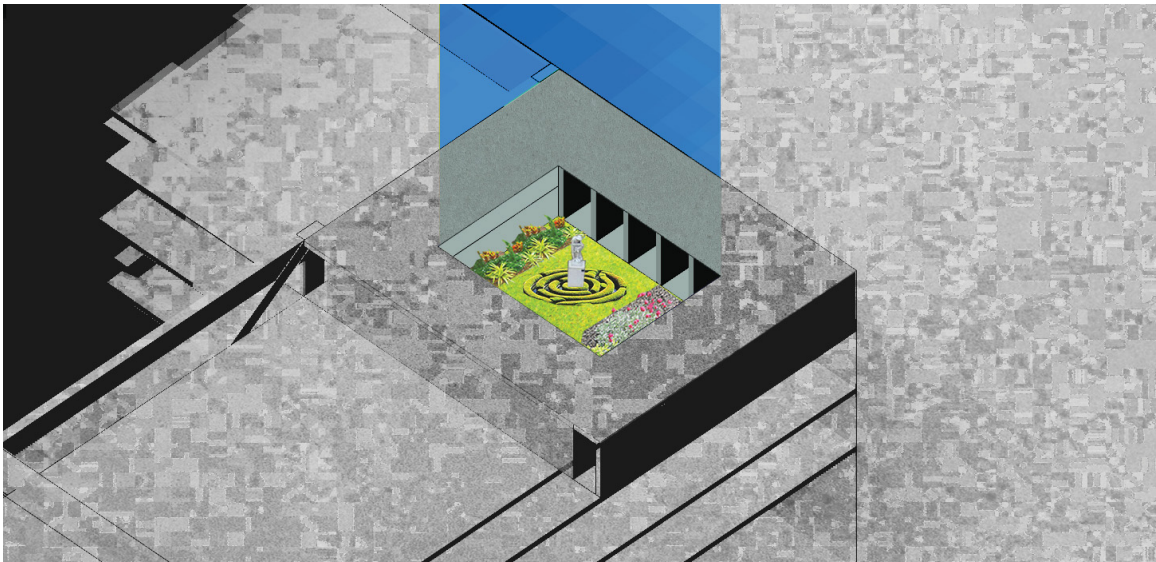

The Isolation Gardens, separating out all digital noise

The Isolation Gardens offer this area of exclusion within the library using heavy concrete walls to exclude Wi-Fi and satellite Internet signals. The layout of the gardens further intensifies the feeling of exclusion by rejecting the horizon, opening only to the sky above to create a sense of calmness for intensified inward focus. The design of this space is heavily influenced by Peter Zumthor's design of the Hortus Conclusus for the 2011 Serpentine Pavilion in London's Hyde Park. Director of the project, Hans Ulrich Obrist states,

The 2011 Pavilion has been created both as a monumental structure and as a site of emotional encounter. Zumthor has stated that his design "aims to help its audience take the time to relax, to observe and then, perhaps, start to talk again - or maybe not." With a refined selection of materials he has created a contemplative space that evokes the spiritual dimension of our physical environment, successfully emphasizing the whole of the senses and emotions play in our experience of architecture. (O'Brien 2011)

While it is of utmost importance to make the most use out of the new tools and resources that are available, testing them, breaking them and adapting them, it is also important to get away from them to reflect and challenge the ways in which we practice and approach knowledge. As one of the last truly public spaces the library must include seemingly contradictory spaces, to reconstruct a truly heterotopic space. In the adapted library, forms of intensified virtual and physical connection are made possible, as well as intensified moments of disconnection.

CHAPTER 4: CONCLUSION

With the immense speed at which information technology is adapting the library needs to update itself adequately to reflect and represent the changing contemporary practices of its users. By examining the existing conditions of the typology to be blended with emerging cultural practices, the library can be successfully updated into the present condition. With the library updated it will continue to operate as one of societies most important public typologies, allowing us to explore our deepest desires, and challenge ourselves to explore the limits of what is possible in our near future.

REFERENCES

- Assange, Julian. 2013. "The Banality of Google's Don't Be Evil" *The New York Times*, June 20.
- Bedwell, Linda. 2013. "LibQUAL+ 2013." Producer, Dalhousie University Libraries.
- Blouin, Richard. 2005. Interview of Ojar Biskaps. E-mail. Halifax, N.S. 27 January.
- Blum, Andrew. 2013. *Tubes: A Journey to the Center of the Internet*. New York: Ecco.
- Chung, Chuihua Judy, and Sze Tsung Leong. 2001. *Harvard Design School Guide to Shopping*. Cologne: Taschen.
- Dade-Robertson, Martyn. 2011. *The Architecture of Information*. New York: Routledge.
- Dalhousie University. 2006. "The Buildings of Dalhousie University: An Illustrated History." http://www.library.dal.ca/DUASC/Digital_Collections/Buildings/.
- Foucault, Michel. 1984. "Of Other Spaces, Heterotopias". *Architecture, Mouvement, Continuité* 5: 46-49.
- Graham, Dan. 1999. *Two-Way Mirror Power: Selected Writings by Dan Graham on His Art*. Edited by Alexander Alberro. Cambridge, MA: MIT Press.
- Hill, Dan. 2012. *Dark Matter and Trojan Horses: A Strategic Design Vocabulary*. Moscow: Strelka Press.
- IBI Group. 2010. Dalhousie University Campus Master Plan, Framework Plan. Dalhousie University Website. <http://www.dal.ca/dept/facilities/campus-development/about-master-plan.html>.

- Kanazawa Institute Of Technology. "Automated library system with retrieving and respositing robot". <http://www.google.co.in/patents/US6535790> (accessed 1 Feb. 2013).
- Klingmann, Anna. 2001. "Datascapes: Libraries as Information Landscapes." <http://www.klingmann.com/img/research/publications/articles/23/23.pdf>.
- Koolhaas, Rem, and Bruce Mau. 1995. *S,M,L,XL*. New York: Monacelli Press.
- Littlefair-Wallace, Sam. 2013. "Books and Mortar." *The Coast* (Halifax). August 29. <http://www.thecoast.ca/halifax/books-and-mortar/Content?oid=4007227>.
- Lynch, Kevin. 1960. *The Image of the City*. Cambridge, Massachusetts: MIT Press.
- Maes, William. 2004. Interview by Alanna Mollo. Tape recording. Halifax, N.S.
- Manovich, Lev. 2001. *The Language of New Media*. Cambridge, Massachusetts: MIT Press.
- Markus, Thomas A. 1993. *Buildings and Power: Freedom and Control in the Origin of Modern Building Types*. New York: Routledge.
- Marquez, Fernando. 2005. *Rem Koolhaas 1987-1998*. Madrid: El Croquis.
- May, Kyle, Julia Van den Hout, Jacob Reidel, and Human Wu. 2012a. "Data Space, introduction." *CLOG Journal*.3.
- May, Kyle, Julia Van den Hout, Jacob Reidel, and Human Wu. 2012b. "Brutalism." *CLOG Journal*.6.
- McLuhan, Marshall, Quentin Fiore and Jerome Agel. 1967. *The Medium is the Massage*. New York: Bantam Books.

Newspaper Articles on Killam Library. Dalhousie Gazette (Halifax). 1960s.

“A note on the Killam Memorial Library” 1974 October 2.

O’Brien, Sophie. 2011. *Peter Zumthor Hortus Conclusus*. London: Koenig Books.

Pallasmaa, Juahni. 2012. “Newness, Tradition and Identity: Existential Content and Meaning in Architecture.” *Architecture Design* 82: 14–21.

Picon, Antoine. 2010. *Digital Culture in Architecture*. Basel: Birkhauser.

PriMetrica Inc.. 2013. Submarine Cable Map. <http://www.submarinecablemap.com/>.

Riggs, Jo-Ann. 2005. Interview of Ojar Biskaps. E-mail. Halifax, N.S., 28 January 2005.

Tammy. 2006. “Ojar Biskaps Obituary.” *The Chronicle Herald* (Halifax). <http://archiver.rootsweb.ancestry.com/th/read/CAN-NS-OBITS/2007-01/1168117156>.

Von Foerster, H. 1973. “On Constructing a Reality.” *Principia Cybernetica Web*. <http://cleamc11.vub.ac.be/Books/Foerster-constructingreality.pdf>.

Wikimedia Foundation. “Dom-ino House”. https://en.wikipedia.org/wiki/Dom-ino_House. (Accessed 6 Dec. 2013)