

**SABLE ISLAND NATIONAL PARK:
DESIGN WITH A DYNAMIC ECOSYSTEM**

by

Matthew Griffin-Allwood

Submitted in partial fulfilment of the requirements
for the degree of Master of Architecture

at

Dalhousie University
Halifax, Nova Scotia
March 2014

© Copyright by Matthew Griffin-Allwood, 2014

CONTENTS

Abstract	iii
Acknowledgements	iv
Chapter 1: Introduction	1
Design with Dynamic Ecosystems.....	1
Visiting a Dynamic Site	2
A History of Change.....	7
To Connect, Not to Conquer	12
Design With Sable Island	20
Chapter 2: Design.....	26
Site Dynamics and Program.....	26
East Light and West Light Shelters	47
Visitor / Research Centre.....	66
Main Station.....	79
Chapter 3: Conclusion	97
References	98

ABSTRACT

To design with a changing ecosystem requires examining and understanding site dynamics, extracting guidelines for making architectural decisions and defining processes that allow for change. Sable Island National Park is an ideal case study to test this method because its simple and dynamic ecosystem defines clear guidelines and requirements for adaptation.

The proposed National Park infrastructure remodels human interaction with Sable Island by replacing and remediating existing settlements. Designed to be sensitive to and participate in the island's natural processes, the new architecture protects the delicate ecosystem and facilitates low impact visitation. The systems, spaces and experiences serve to deepen understanding of human interdependence with the environment.

ACKNOWLEDGEMENTS

Thank you to Parks Canada for the exciting opportunity to visit and study Sable Island.

Thank you to Jonathan Sheppard, Aaron Carpenter, Brent Ford, Ned King and Bob Taylor for help with research. The mysteries of Sable Island were much easier to study and understand with their expert knowledge and experience. Thought provoking “sushi nights” with Jonathan provided fresh inspiration, as well as welcome breaks from long studio hours.

Thank you to Richard Kroeker, and Catherine Venart for their academic guidance and criticism. Their dedication to the project and provision of excellent company made the thesis process both appropriately rigorous and enjoyable.

Thank you to my excellent studio mates, Nuala O’Donnell, Maxwell Schnutgen and Beth MacLeod for helping with models and giving great advice.

Last, and certainly not least, thank you to my wonderful family. Marianne’s love and support make the challenging days good and the good days even better. James’ twenty-four hour tech support is second to none, and always entertaining. And my mother’s willingness to revise drafts at any hour, in addition to supplying delicious home cooked meals, make her invaluable.

CHAPTER 1: INTRODUCTION

Design with Dynamic Ecosystems

A dynamic ecosystem can be defined as one which naturally changes faster than its human settlements. Development in these ecosystems is often avoided because inevitable landscape changes are difficult to predict and not easily accommodated by traditional building methods and technologies. In some cases infrastructure development in dynamic ecosystems is necessary and demands architecture designed to thrive in changing habitats.

To design with a dynamic ecosystem requires:

a) Learning from ecosystems - Instead of just studying a place for site characteristics, one must study an ecosystem to understand site dynamics.

b) Extracting principles- Understanding site dynamics provides a set of architectural guidelines for intervention in that place.

c) Defining processes for architectural adaptation - One must recognize that interventions are not timeless, and therefore need the ability to adapt to their changing habitat.

Sable Island is an excellent example of a dynamic ecosystem; for hundreds of years settlers have had little success building in the fluid landscape. The island's recent designation as a National Park presents an opportunity to remodel human interaction with its fragile environment. The design for Sable Island National Park expressed in this thesis serves as a case study for testing design with dynamic ecosystems. Analyses of the island's natural constraints and processes will provide the basis to propose architecture sensitive to and participating in Sable Island's unique environment.



A house being engulfed by sand on Sable Island (Campbell 1974) (left) and (Zinck 1979) (right).

Visiting a Dynamic Site

On the edge of the continental shelf, between the Gulf Stream and Labrador Current, 175 kilometres from the nearest point of land in Nova Scotia, Canada and 300 kilometres southeast of Halifax, lies Sable Island. The crescent shaped island, approximately 42 kilometres long and 1 kilometre wide, is the emergent tip of a sand bar formed on a glacial moraine. Its geological composition is homogenous, “There’s no stone, no rock — not even a pebble — on the island,” Mr. de Villiers said. “Years and years ago, a drill was sent down 10,000 feet, and they found nothing but sand.” (Carlson 2011)

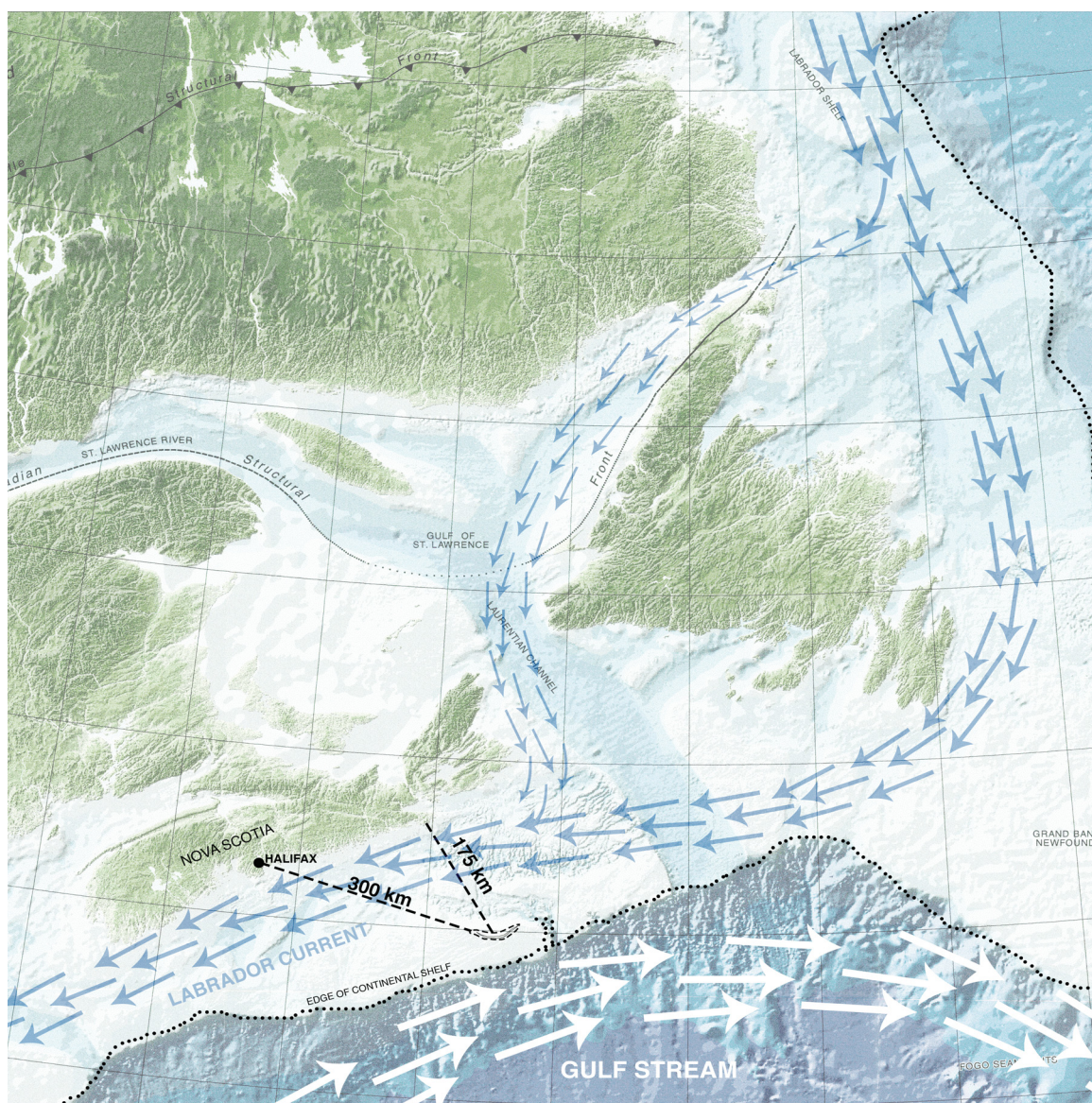

Notations drawn on a topography and bathymetry chart from Oakey 1999

Sable Island is a unique and delicate ecosystem, “. . . characterized by sand dunes and grasses and is home to over 190 plant species and 350 species of birds, including the endangered roseate tern. The island’s most famous inhabitants are its iconic wild horses, of which there are approximately 500.” (Parks Canada 2013). The shallow coastal waters are both fatal and fertile. Sable Island, “is anything but a harmless strip of sand. Its swirling waters are known as the Graveyard of the Atlantic, for they have swallowed 350 ships since 1583. Its underwater Scotian Shelf hosts 18 shark species who feast on the island’s grey seals.” (Carlson 2011)

The shape of the island is constantly shifting as it is blasted by storms; “the length of each spit can change by up to four or five miles in a single savage storm.” (De Villiers and Hirtle 2004, 49). Though storms that change, remove and add to habitats may seem destructive, they supply the island’s aquifer with fresh water which makes life on Sable Island possible.

The ponds are just the surface manifestation of the underlying aquifer. Life on Sable Island is made possible and sustained by that aquifer, . . . there is salt water on every side in such volumes, and in many places salt water on the surface, and frequent vertical intrusions of salt into the fresh water - why and how does the fresh water stay fresh? Are the rains sufficient to keep it so? The answer is yes, but not by much. (De Villiers and Hirtle 2004, 126-127)

On June 19, 2013 a bill was passed establishing Sable Island as Canada’s 43rd National Park under the protection of Parks Canada. This designation adds legislations which protect the island’s delicate ecosystem. For example, exploitation of the island for oil exploration is no longer allowed. “Now that Sable Island is a national park, [oil] rigs are prohibited within one nautical mile of its shores, and its surface will never again be drilled.” (Carlson 2011) Conversely, designation as a National Park opens Sable Island to potential exploitation through tourism.

Parks Canada spokeswoman, Julie Tompa, is quoted in Gordon Delaney’s article for The Chronicle Herald on June 16th, 2013, “Facilitating opportunities for people to visit and connect with the places, within a conservation context, is a key element of Parks Canada’s mandate. . . That’s no different for Sable Island. . . It’s certainly a place that inspires people and captures their imaginations.” Tompa suggests that some, conservation focused, tourism on Sable Island is in Parks Canada’s plan.

Some conservationists are opposed to tourist visitation on Sable Island because of the

potential negative environmental impacts created by increased human presence.

There is a great deal of public interest in Sable Island, and much desire by individuals to experience its fascinating ecological and cultural heritage. These desires must be weighed against the possibility that tourism could seriously damage Sable Island through erosion, pollution, disturbance of wildlife and a variety of other foreseen and unforeseen factors. (Nature Conservation (BIOL 3601) 2006, 3)

Conservationists opposed to tourism on Sable Island offer alternatives. In the Toronto Star article, “Sable Island: A national park that we could love to death” published on May 4, 2013 Alyshah Hasham writes,

You can easily love the island to death,” said Mark Butler, policy director of the Ecological Action Centre.

He and other conservationists fear that the expected influx of tourists eager to see the stark beauty of the island for themselves could harm the fragile ecosystem. . . He says Parks Canada should put a cap on the number of visitors allowed [to visit] the island — perhaps fewer than 300 a year.

Instead, an interpretation centre in Halifax using interactive displays and live webcams could “bring Sable Island to the people rather than the people to Sable Island,” said Miller.

Both Butler and Miller say public feedback supports keeping traffic low to the tiny island.

Not all are opposed to tourism; some feel, if done properly, tourism on Sable Island could be beneficial. April Hennigar, chairwoman of the Friends of Sable Island Society, is quoted in Gordon Delany’s article, “Missisauga firm plans to offer tours to Sable Island”, in The Chronicle Herald on June 16th, 2013,

April Hennigar said in an email that Parks Canada will have to balance its mandate to encourage visitors with the need to protect the island’s fragile environment.

“We support controlled and limited tourism activities . . . to ensure that the Sable Island story remains alive in the hearts and minds of Canadians,” she said.

But they must be “no-trace” visits, with arrival and departure by boat, short day-trips, no-impact beach walks and guided, interpretive tours of the more fragile areas.

“Our main concern is with the size of the groups visiting Sable Island and the capacity of the island to handle them,” she said.

Hennigar said all visitors should receive educational materials before arriving, instruction about conduct on the island and they should be monitored for compliance.

Gerry Forbes and Zoe Lucas have been living on Sable Island for many years conducting research and protecting the site. Zoe Lucas was interviewed in The Walrus’ May 2012 magazine article by Joel McConvey “A Park Apart”.

. . .some human presence on the island is not a bad thing. . . It’s great being on an island

with no people around,” says Lucas, but she points out that Sable Island is not the unspoiled Eden some people think it is. The cruise ships are new, but tourism is not. “There have been visitors to Sable Island going way back to the 1800s, when people were coming to look at birds and whatnot,” she says. “So the notion that it can be left alone is not going to work. It may be far offshore, but it’s more accessible now because of modern technology: anyone with a boat and a GPS can get to Sable Island. It has to have a human presence now to be protected.” As to whether the national park model is the right way to maintain that presence, she cautiously supports the designation. “If people can come to Sable Island and not harm it, there’s no reason not to allow them,” she says. “It’s good for Sable, and it’s good for people. (McConvey 2012)

Other National Parks in popular, sensitive and remote areas control access and activities. Yosemite National Park’s popular Half Dome Trail has controlled access; only lucky winners of a preseason permit-lottery get to hike all the way to the summit. This control was started because the trail was being over crowded, creating safety hazards. “Crowding has raised concerns about the safety of both the public and rescue personnel on the cables.”(National Park Service 2012)

Galapagos National Park is one of the most famous wildlife-watching destinations in the world; its biodiversity and interesting sights draw thousands of tourists every year. The remote archipelago’s ecosystem is threatened by the introduction of tourists, so access is tightly controlled (Carwardine 2012).

170,000 tourists visited the Galápagos last year. . . You’re only allowed to visit tiny pockets of the national park, you can disembark (from small boats) only at designated landing spots, you must walk only on clearly marked trails in strictly disciplined small groups, and you must be accompanied by local certified guides. Regulating tourism with such military efficiency may feel extreme, but it is essential under the circumstances. (Carwardine 2012)

Visiting Auyuittuq National Park in Iqaluit, Canada, can be dangerous and requires planning, orientation and registration. All visitors are mandated to attend a three hour orientation session where they are informed of hazards, risks, current route conditions and polar bear sightings. Parks Canada requires visitors to provide information about their itinerary and sign in and out of the park. “For visitor safety, it is mandatory to register all trips into the park prior to entering and to de-register upon exiting.” (Parks Canada 2014)

Similar access and activity control strategies can be implemented to facilitate low impact visitation on Sable Island. To control the number of tourists visiting, a permit lottery could be implemented where potential visitors apply for a chance to visit. The lucky winners could be required to attend mandatory orientation to learn about Sable Island’s fragile

ecosystem. Once on the island, visitors could be accompanied by a guide who ensures regulations are followed.

Conversation continues about what kind of tourism, if any, is appropriate for Sable Island, but Parks Canada is clear about its position.

Make no mistake: Parks Canada wants Canadians to use their national parks. “It’s not protection for protection’s sake,” says Julie Tompa, project manager for the establishment of Sable Island National Park. “It’s protection for the use, enjoyment, and appreciation of Canadians. People need to experience [the parks], whether by getting out there themselves, or through some kind of outreach or education.” She cites research that says Canadians who have the opportunity to experience parks first-hand are far more likely to advocate for their conservation in the long term. But access makes certain demands (the more people you have, the more infrastructure you need to accommodate them), which in an environment as fragile as Sable Island can be hazardous. So lines are drawn in the sand: No wharf, no boardwalks. Definitely no hot dog stands. No feeding the ponies. (McConvey 2012)

Parks Canada’s plan for Sable Island includes tourism; the mandate displayed on the Parks Canada website states a desire to “protect and present” (Parks Canada 2013). The next step toward realizing their plans, and the focus of this thesis, is to develop an infrastructure and strategy which both protects the fragile ecosystem and facilitates low impact visitation.



Hikers on Bald Dune (Parks Canada 2013)

A History of Change

Sable Island's remote position, unique ecosystem and intricate balance make it an engaging, dynamic landscape which has captivated human attention for centuries. Like Sable Island's shores which, due to erosion and deposition, are in a constant state of change, so the human understanding of the island's value has shifted through history.

In the 17th and 18th century colonists from North America established settlements to exploit the island's natural resources.

...the great era of Sable exploitation from neighbouring North America had begun. . .The chief natural resource continued to be the animal life. The method of exploiting this resource was slaughter. For the first time in Sable Island's history events gave rise to the question whether Sable was more a threat to the lives of men than men were to the life of the island. . . The two most valuable products of the island at that time were black fox skins and the ivory tusks of the walrus . . . Both animals were plentiful on Sable Island for a while, perhaps even more plentiful than the seals that still survive. . . The constant hunting was to have a lasting effect, and by the end of the century both the walrus and black fox were virtually extinct.(Campbell 1974, 24-29)



Wrecker's den by Des Barres 1766-67 (Campbell 1994)



A walrus drawn for the British public in the seventeenth century (Campbell 1994)

In 1801, the Canadian government established a life saving station on Sable Island to provide relief for victims of shipwrecks. "In early June 1801. . . On 15 June it [the House of Assembly] appointed a committee to devise a plan for settling some families of good character on Sable Island for the preservation of lives and property wrecked there." (Campbell 1994, 52)

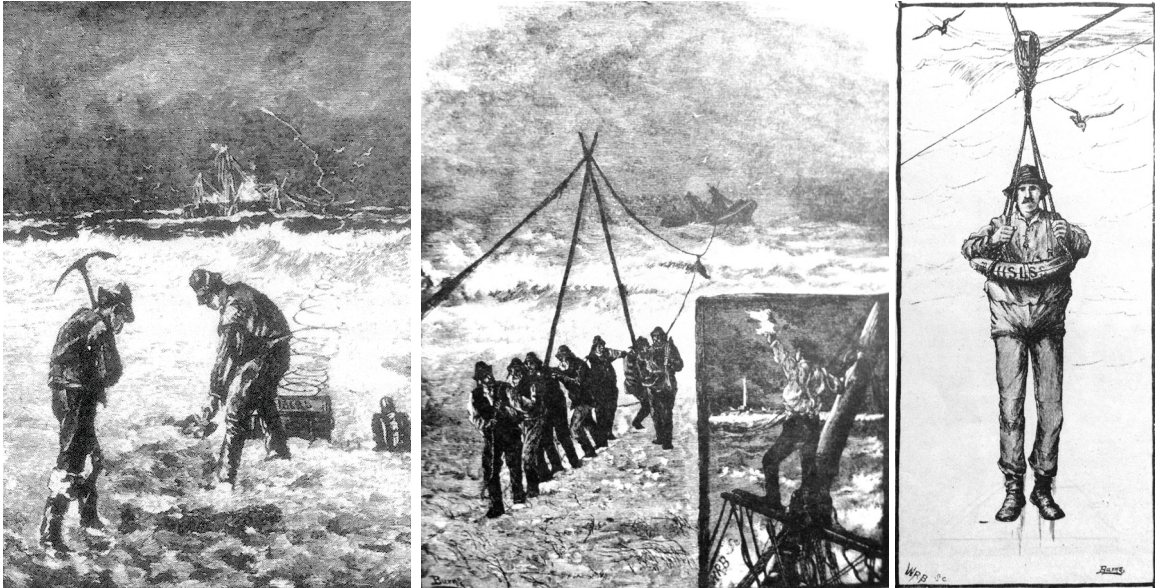

The Life saving crew used man power and simple machines like the rocket apparatus (left), pulley system (middle) and breeches buoy (right) to rescue wrecked sailors (Campbell 1994)



Number Three Life Saving Station, Sable Island, 1890 (Campbell 1994) (left)
Foundation of Number Three Station emerging from sand, Sable Island, 2014 (right)

The long term government settlement experienced the dramatic consequences of Sable Island's shifting shores. "The buildings which had been most vulnerable to the sea had been those on the west end. There, the land had been gobbled up at an alarming rate. Small wonder that some years prior to going to Sable -- early in Darby's time, he thought -- the principal station had been moved from this end to the middle of the island." (Mitcham 1989, 73)

"Those who had lived on the island for a number of years, gave testimony that the island was slowly wasting away" (50)

1801

"We had to pull down all the buildings and relocate them in the middle of the island, which is about three miles farther east." (50)

1814

"By 1833, the sea had swept the island so rapidly that it was within half a mile of the buildings and new ones were being erected four miles farther eastward." (50)

1833

"It was not until 1873 that the Dominion government decided to construct two powerful lights upon the island, one at either end, at a cost of \$80,000." (46)

1873

"The sea settled a little and then it again started its advance. . . causing the lighthouse to lean forward. Within the next force of waves, it came crashing down into the water. The light was again erected about a mile further east" (51)

1882

". . . but the sea continued its advances, so that by 1888 it was a must that the light be removed a further two miles to the east" (51)

1888

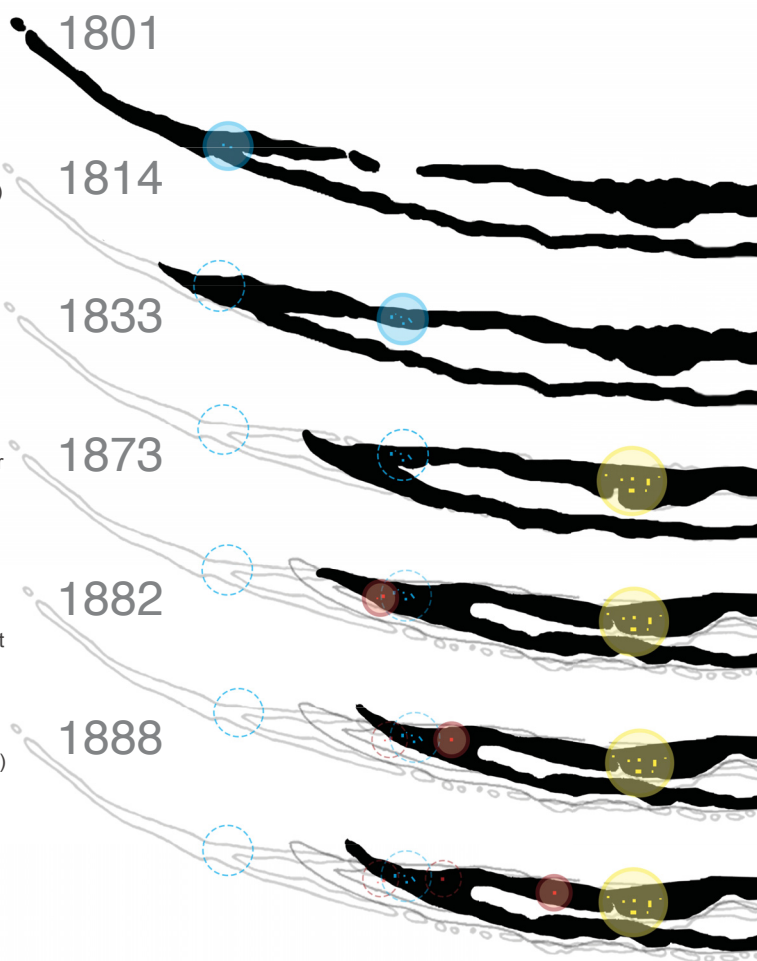

Graphic interpretations of Jack Zinck's description of building relocations and reconstructions due to changing shorelines on Sable Island. (Zinck 1979, 46-51). Shorelines are estimated using Zinck's descriptions, and historic maps shown in Campbell's *Sable Island Shipwrecks: Disaster and Survival at the North Atlantic Graveyard* (1994).

By the 1950s the government's interest in Sable Island turned to oil exploration.

The Canadian Government's other plans for Sable Island involved a return to the seveneenth-century attitude toward it, the viewing of it with an eye toward exploitation. There were various ways of deriving profit from Sable in the twentieth century. The possibilities included strip-mining, the operation of a holiday resort, and oil drilling. Not surprisingly, it was the most powerful of these interests that won whatever competition there was. The Sable Island Humane Establishment had barely come to an end when the oilmen staked their claim to Sable.

In 1959 the Mobil Oil Co. of Canada was granted the first permits for oil exploration off Nova Scotia, and the centre for their 600,000 acre tract was Sable Island. (Campbell 1974, 89)



The West Spit Mobil Oil operation, Sable Island, 1971 (Campbell 1974) (left)
Remnants of a Mobil Oil operation, Sable Island, 2014 (right)

In the 1970s Canadians identified the fragile nature of Sable Island's dunes and terrain, understanding the harmful effects of human impact.

Evidence of the island wasting away has caused great concern to both the Federal and Provincial Government. After careful consideration from all parties concerned, it was decided that what was left of the island must be saved, and in 1974, a subcommittee was established for the purpose of carrying out a terrain management program. Under the supervision of the Environmental Advisory Committee, their object was the restoration and repairing of Sable Island. (Zinck 1979, 70)



Research camp, Sable Island, 1980, photograph by Paul Toman (Panoramio 2014) (left)
Research camp buried up to the second floor, Sable Island, 2014 (right)

Official government management of Sable Island has traditionally been the responsibility of the Canadian Coast Guard, which ran the life saving station. As navigation technologies improved fewer vessels were wrecked on the island, and the Coast Guard presence on site became less relevant. Increasing interest in scientific and historic research on Sable Island made Parks Canada a natural candidate to assume responsibility for the island.

Sable Island was finding itself orphaned from oversight. It was previously under the purview of the Canadian Coast Guard because it has traditionally been a hazard to ships.

But as modern GPS technology mitigated that threat, the coast guard had little role to play and little expertise in overseeing a unique ecological system. Virtually everyone agreed Parks Canada was the government body best suited to look after Sable. (MacLeod 2013)



Some of the wild horses were domesticated to aid in transportation, Sable Island, 1957, photograph by Curtis Griffin (left)

All terrain vehicles are now the primary means of transportation and no horses are domesticated, Sable Island, 2014, photograph from Parks Canada (right)



Supply ships sent cargo ashore in life boats which were carefully landed in the rough surf, Sable Island, 1957, photograph by Curtis Griffin (left)

A landing craft is launched from the supply ship to bring cargo ashore now, Sable Island, 2014, photograph from Parks Canada (right)

To Connect, Not to Conquer

Many have tried to establish infrastructure on Sable Island, but in the dynamic landscape few structures stand the test of time. There has always been friction between human settlements and Sable Island's landscape; past inhabitants carved out and fenced in "their" lot only to have the land rise up and consume it, burying their plans. When considering building on Sable Island one cannot presume to conquer the land; the opposite is more likely. If one decides to connect with the island's natural systems and participate in their wind driven dance, a mutually beneficial relationship is possible. That relationship can generate a new architecture, shifting in harmony with the dunes.



Superintendent Boutlier's Main Station, Sable Island, 1890 (Campbell 1994)



Remnants of Old Main Station are buried in sand, Sable Island, 2014

Parks Canada is the next in a long line of stewards to inherit the role of managing human interaction with Sable Island. Now, at the outset, they have an opportunity to change the approach of habitation on Sable Island from one of conquering, to one of connection. On Parks Canada's website (Parks Canada 2013) their mandate states,

On behalf of the people of Canada, we protect and present nationally significant examples of Canada's natural and cultural heritage, and foster public understanding, appreciation and enjoyment in ways that ensure the ecological and commemorative integrity of these places for present and future generations.

Canada's Environment Minister, Peter Kent, is quoted on Parks Canada's website (Parks Canada 2013) stating,

The long-term legal protection of Sable Island as a national park reserve is a tremendous achievement for all Canadians, . . . We can now be assured that this fragile and iconic island will be protected forever, with its stories shared with all Canadians and passed on to future generations.

Parks Canada states their primary commitment: "To protect, as a first priority, the natural and cultural heritage of our special places and ensure that they remain healthy and whole." (Parks Canada 2013)

Goals to "foster public understanding" and "share its stories with all Canadians" suggests national park programs are intended to connect their inhabitants and visitors with unique ecosystems. Parks Canada and Minister Kent also stress the importance of protection to ensure ecological integrity. Based on Parks Canada's mandate a sustainable infrastructure for Sable Island National Park must have minimal environmental impact on Sable Island, employ site appropriate design with a low impact maintenance strategy and act as a vessel to connect its inhabitants and visitors with its place.

The Norwegian Wild Reindeer Pavilion, designed by Snøhetta, in Dovrefjell National Park achieves such connections; in the harsh mountain climate the pavilion offers shelter to hikers and tour groups. Similar to Sable Island, Dovrefjell was recently established as a National Park and locations for building park infrastructure were carefully considered.

It was only possible to build the pavilion on such a sensitive site because it already contained two nondescript military buildings which have since been demolished. The 1,700sq km Dovrefjell National Park was established in 2002 having previously been an army firing range. Mineral mining had also been carried out in the area. The park is still undergoing an extensive cleanup programme involving the removal of roads and ammunition. (Birch 2011)

The new infrastructure avoids disturbing natural habitat by redeveloping and remediating existing settled areas. The structure forms a kind of inverse zoo where people enter an enclosure to view the animals. It provides a warm, dry place for visitors to take in the spectacular views; in their concealed environment visitors can closely observe, without disturbing, protected reindeer, musk-ox and polar foxes as they wander past (Birch 2011).

“The whole structure was transported to the site in three large pieces.” (Birch 2011) Prefabrication limits the amount of on-site construction work, and avoids the environmental impact caused by large building crews in sensitive habitats.



The wooden core forms the south facade (left) and interior resting places (right) (Birch 2011)



Musk ox gather near the Pavilion (left) (Birch 2011)
the north glass facade reflects it's surroundings (right) (Birch 2011)

The existing operational buildings on Sable Island depend upon designs and technologies inappropriate for their environment and should be removed. Most structures have

tall, vinyl clad facades facing the prevailing wind. Vinyl siding commonly fails during high winds, with pieces blown and littered across the island, requiring frequent maintenance. Concrete strip / block foundations are the most common building to ground connections which in some cases result in sand drifting against buildings.

Currently there are approximately 16 working buildings on Sable Island. These are owned and operated by Environment Canada, the Department of Fisheries and Oceans, the Province of Nova Scotia and Exxon. . . All buildings are currently private and closed to the general public. Current sewage treatment facilities are in place for a small population and would need re-formatting to accommodate additional visitors.

There are no available shelters, eating facilities or accommodations available for tourists. . . In addition, constant shifting of sands has led to the burial and destruction of historic buildings on the island. Existing buildings require regular maintenance to prevent this from occurring. (Nature Conservation (BIOL 3601), 2006, 5)



Images of sand engulfing buildings at west light (left) and Main Station (right), Sable Island, 2011, photographs from Parks Canada



Images of vinyl siding being blown off of buildings at Main Station, Sable Island, 2011, photographs from Parks Canada

Maintenance, and material transport or sand removal can require heavy vehicles on roads crossing fragile dune habitat, increasing risks of erosion. "...people-related activities have induced tendencies of erosion and deterioration in areas that might otherwise be relatively stable." (Lucas 1980, 45)

When buildings reach the end of their useable service life on Sable island they are typically abandoned, introducing health and safety hazards and pollutants to the ecosystem as the buildings decay. In Philly.com's article, "How abandoned buildings could make you sick", published on July 13, 2012 Jonathan Purtle writes, "Many of the health and safety hazards that go along with abandonment are undeniably real, and rather obvious: fire, falling debris, vermin, sharp rusty objects, dangerous machinery, mold, standing water, and toxic chemicals would be partial list."

Sable Island's existing infrastructure is constructed with products containing asphalt (shingles), various plastics (siding, caulking, etc), fibreglass (insulation) and chemicals (fuel storage equipment), which, if left to decay, would negatively impact the island's ecosystem.



Images of abandoned buildings and debris littering human inhabited sites, Sable Island, 2011, photographs from Parks Canada

Robust building systems and connections, low impact construction, operation and maintenance strategies and design responsive to the changing landscape are necessary for new infrastructure. Antarctic stations must consider access, construction and maintenance challenges similar to those experienced on Sable Island. The Princess Elisabeth Belgian Antarctic Station is elevated above its dynamic environment and is powered by solar and wind energy (International Polar Foundation 2013).

Princess Elisabeth is the world's first Zero Emission polar research station. . . [it] is an evolving technical prototype. . . Princess Elisabeth Antarctica's design and construction seamlessly integrates passive building technologies, renewable wind and solar energy, water treatment facilities, continuously monitored power demand and a smart grid for maximising energy efficiency. (International Polar Foundation 2013)

The Halley VI British Antarctic research station is located on the Brunt Ice Shelf. The first Halley stations were destroyed by snow and shifting ice, but the fifth survives because it

can be raised on stilts above drifting snow. Eventually though, its site will break off as the shelf moves toward the Wedell Sea. Designing for the dynamic ice shelf, Hugh-Broughton Architects proposed a caravan of mobile station modules on skis (Salvid 2010).

Their design consists of a series of linked modules on stilts that can be raised with far less effort than Halley V, allowing more of the team brought to the Antarctic to carry out scientific rather than maintenance work. . . The modules are on skis and can easily be pulled to a new location. Broughton's design also improves living conditions - especially important for the overwintering crew, who are there for eight months. . . (Slavid 2010)

The station's prefabricated components and freeze proof glass reinforced cladding system require minimal maintenance and were easily assembled on site (Slavid 2010).



Princess Elisabeth Belgian Antarctic Station (International Polar Foundation 2013)

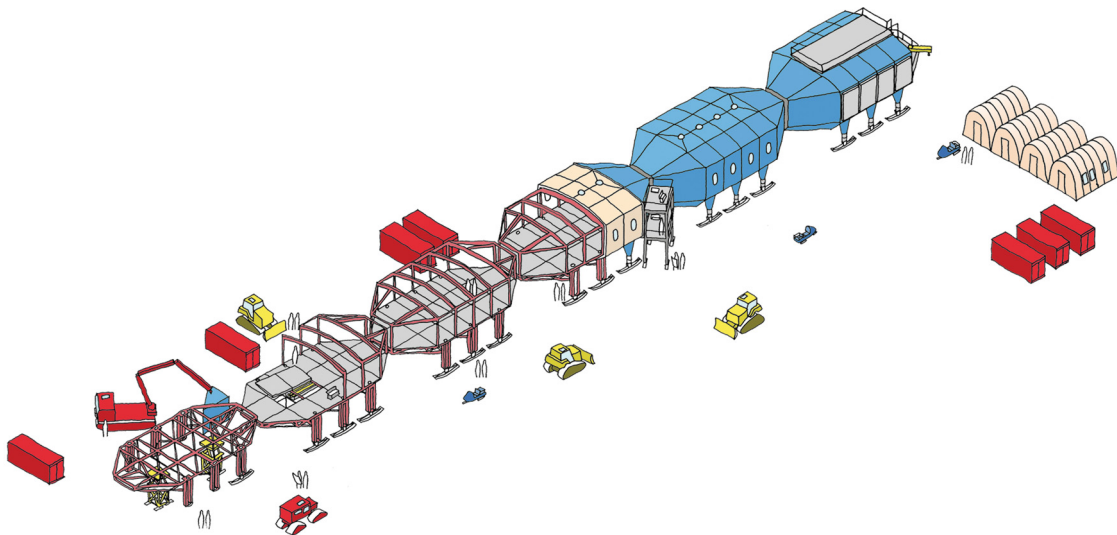

Diagram of the Halley VI construction process using prefabricated components (Slavid 2010)

Reducing energy demand with passive design strategies and simple technologies can make Sable Island's new infrastructure efficient and easy to operate. Crosson Clarke Carnachan Architects' Whanapoua Hut on Sleds is a good example of an adaptable structure that can be tuned to its environment. Overlapping functions in interior spaces reduces climate controlled volume and solar awnings allow for passive heating in the winter, provide shade in the summer and close to become storm doors to protect against bad weather. (Crosson Clarke Carnachan Architects 2014)

Designed to close up against the elements, the hut measures a mere 40 square metres and rests on two thick wooden sleds that allow it to be shifted around the beach front section. This innovative portability is a response to the ever changing landscape that lines the beachfront in this coastal erosion zone. (Crosson Clarke Carnachan Architects 2014)



Storm doors / solar awnings being opened (left) (Crosson Clarke Carnachan Architects 2014)
Hut being towed by tractor (right) (Crosson Clarke Carnachan Architects 2014)

Cladding for new infrastructure should be durable to withstand Sable Island's intense storms and require little or no maintenance. The existing lighthouse structures on Sable Island are made of structural aluminium and have aged very well in the maritime climate. Tested by time, aluminium stands out as one of the least decayed materials observed on Sable Island.



Photographs of West Light (right) and East Light structures (left), Sable Island, 2014

A robust structural aluminium facade system like the one used in Toyo Ito's Aluminium Cottage would perform well on the island. Ito's lightweight system was brought to site in prefabricated parts, installed with bolts by a small work crew and provided structure and shelter as they continued building (Ito 2014).



Toyo Ito, completed Aluminium Cottage (top left and right) (Ito 2014)

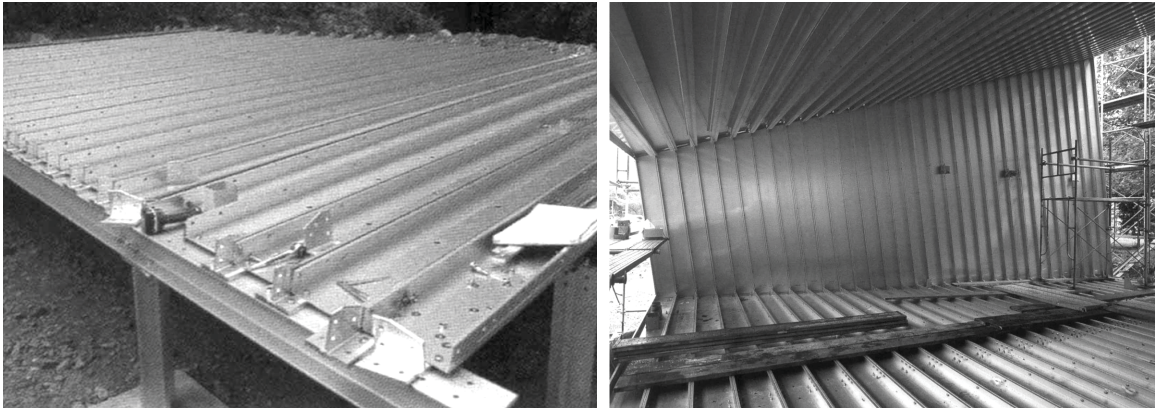

Structural aluminium channels are bolted to beams to form the raised floor (bottom left) (Ito 2014)
 Inside the assembled structural aluminium facade before other building components were added (bottom right) (Ito 2014)

To fulfill Parks Canada's mandate, building abandonment and use of inappropriate technologies which pollute the island must stop. New built infrastructure must be designed to thrive in the island's harsh conditions with low impact construction, operation and maintenance strategies. Replacing existing buildings removes the threat of pollution and presents an opportunity for a fresh start. Analyses of precedents and the landscape's interaction with past settlements inspires a new architecture that connects people with Sable Island's dynamic ecosystem.

Design With Sable Island

Marq deVillier and Shiela Hirtle describe Sable Island's dynamic nature in their book, *A Dune Adrift* as, "yielding in order not to yield" to the, "planetary forces that are at once forming and destroying it." (De Villiers and Hirtle 2004, 3)

Little Sable is besieged and beset by the great planetary forces that made and shape the continents. Yet it is just a sand dune, heaped up in the ocean by the retreating glaciers, shaped and carved and cut away and added to and moved and kept in place by water and wind in all their many incarnations. (De Villiers and Hirtle 2004, 8)

In Sable Island's dynamic ecosystem each element must accommodate the other to maintain the delicate balance of the whole. Plants collect windblown sand and form it into stratified dunes with their roots. The dunes help accumulate fresh water precipitated by storms in the island's aquifer, which nourishes the flora and fauna. When storms hit some of the sand dunes are washed away, along with the plants that made them. The sand is then blown to another part of the shore, where it is collected by other plants, thus starting the cycle again. (Catling, Freedman and Lucas 1984, 216 - 217) Animals inhabiting the island are aware of its constant cyclical dance and join it. They live nomadically, settling in whatever small shelter the island is willing to provide, and relocate when conditions demand. (Zinck 1979, 16-17) This thesis proposes a design strategy which builds on the methodology introduced in Ian McHarg's *Design with Nature*. Taking McHarg's process one step further, the proposed design acts to remediate sites damaged by humans in the past, encouraging it's inhabitant's understanding of and connection to their ecosystem; reconciling them with nature. A strategy to design *with* Sable Island's dynamic ecosystem, allows buildings and people to participate in its cycles, constantly yielding to accommodate other elements, to maintain the balance of the whole.

McHarg's methodology is described by Lewis Mumford in the introduction to *Design with Nature*.

In establishing the necessity for conscious intention, for ethical evaluation, for orderly organization, for deliberate aesthetic expression in handling every part of the environment, McHarg's emphasis is not on either design or nature by itself, but on the preposition with, which implies human cooperation and biological partnership. He seeks, not to arbitrarily impose design, but to use to the fullest the potentialities -- and with them, necessarily, the restrictive conditions -- that nature offers. (McHarg 1969, viii)

McHarg identifies that ecosystems are governed by natural laws, and that humans can

propose designs that operate within those laws; “Let us accept the proposition that nature is process, that it is interacting, that it responds to laws, representing values and opportunities for human use with certain limitations and even prohibitions to certain of these. . . .” (McHarg 1969, 7) His method begins with analyses of the natural processes on a given site to determine which laws apply to a specific ecosystem. In *Design with Nature* McHarg analyzes the coastal dune environment of the New Jersey Shore, an ecosystem similar to Sable Island. “Now dunes are only little sand hills, formed by waves and wind and, where unstabilized, extremely vulnerable to these selfsame forces.” (McHarg 1969, 7) McHarg uses diagrams, mapping and scientific study to develop a set of rules humans can and should follow when considering habitation in the ecosystem of study.

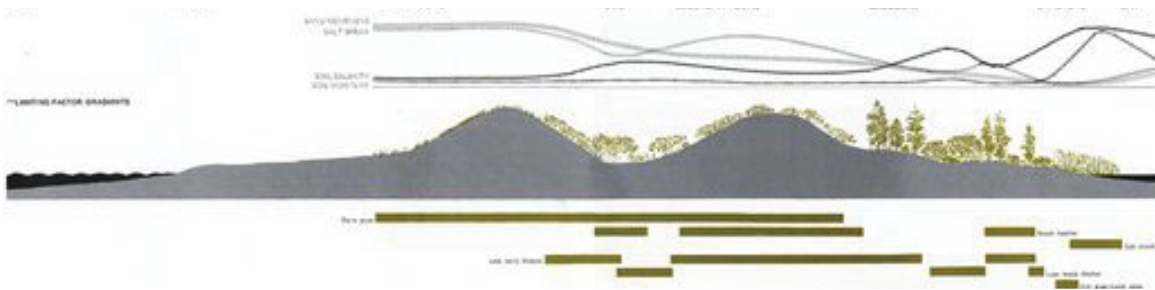

System analysis in McHarg's *Design With Nature* (McHarg 1969, 12)

He continues by using the rules discovered through analysis to guide design choices. This process yields a design which is sensitive to its environment.

We now have a code of basic prohibitions for human use. Thou shalt not walk on the dune grasses. Thou shalt not lower groundwater below the critical level. Thou shalt not interrupt littoral drift. These proscriptions will merely ensure the perpetuation of a natural sandbar and its native vegetation and expression. This will merely sustain a public resource. We must now consider the matter of the people who would like to develop this resource. What should we say to them?

Perhaps the most reasonable approach would be to investigate the tolerance or intolerance of the various environments to human use . . . The first zone is the beach and, fortunately for us all, it is astonishingly tolerant. . . The next zone, the primary dune, is absolutely different; it is absolutely intolerant. . . The trough is much more tolerant; development can occur here. . . Development should not occur on the narrowest sections of the sand bar, for that is where breaching is most likely. . . (McHarg 1969, 13)

McHarg's process establishes a basis from which to make informed design decisions. It is mutually beneficial to those interested in developing in a given ecosystem, and to the ecosystem itself, because it predicates that all introductions to the system must follow naturally predetermined rules.

Applied to Sable Island National Park, this methodology must incorporate more than just the natural laws described by McHarg; it must consider Parks Canada's mandate to limit environmental impact. While obeying natural laws, the new infrastructure and its program can also remediate landscape damaged by previous human activity and propose a new approach to human interaction with Sable Island's landscape. George Descombes' Essay *The Swiss Way* in James Corner's *Recovering Landscapes* discusses the meaning of "recovering" a site for a new design or purpose.

My attitude toward intervening in the landscape circles around paying attention to that which one would like to be present where no one expects it any more. Thus, for me, to recover something -- a site, a place, a history, or an idea -- entails a shift in expectation and point of view. (Corner 1999, 79)

Descombes tries to achieve such shifts using minimal means. He uses subtle interventions to awaken those experiencing a place and the place itself.

Thus, I aim for a precision of disposition, articulation, arrangement -- *architecture* -- so that a preexisting place can be found, disturbed, awakened, and brought to presence. I try to achieve an architecture of place, a construction that jolts its context, scrapes the ordinariness of a situation, and imposes a shift on what seems most obvious. (Corner 1999, 79)

Descombes believes that a designed landscape should highlight changes and shifts over a passage of time and imply further potential for change.

The architecture necessary to mark and make possible such shifts must be more than visual. . . I try to mark the differentiations of a given situation through use of changes in position, light, material, density, intensity, and geometry, embracing all the geological, morphological, vegetal, animal, and human-made dimensions of a place. (Corner 1999, 80)

An example of minimal intervention to highlight aspects of a place is given by Carmen Perrin's boulders. He cleaned lichen, moss and debris off of glacially deposited boulders to reveal the bright granite beneath, showcasing the alien nature of their displacement and their relationship to their relatively new home (Corner 1999, 84).



Carmen Perrin's boulder (Corner 1999, 84)

In his project, *The Swiss Way*, Descombes designs 35 km of pathway for hiking in the mountains. Walking the site repetitively and observing carefully the existing paths, Descombes determined not to add new elements, or introduce a whole new plan, but rather to emphasize existing qualities of the site, and to reveal hidden ones (Corner 1999, 82).

I believe that we must vehemently resist any oversimplification of nature and landscape; our logic and imagination for future settlements cannot be allowed to be predetermined by the planners' formulaic equations and their neatly packaged prototype solutions. As a participant in such resistance, I like the idea of discrete, tactical operations over the clumsy "totality" of the master plan (Corner 1999, 81)

Sable Island already naturally achieves some of the effects Descombes describes. Its history of shipwrecks and past settlements, combined with the shifting terrain, make an earthen museum of "exhibits" in the form of wrecks, artifacts and debris. The exhibition is collected by the ocean and curated by sand. Walking the beaches one might see nothing but the usual animals, vegetation and sand, but after a storm a three hundred year old shipwreck may be revealed. The alien form rises out of the dunes from a distant age; sharing it's secrets for a short time before the next storm washes it away or reburies it.

Similarly Sable Island horses are alien forms from a distant age. Assumed to have been brought to Sable Island after Acadian expulsion from Nova Scotia in 1755 (DeVilliers and Hirtle 2004, 117), the horses have learned to thrive in an unfamiliar environment. As one walks the beaches, Descombe's concept of awakening becomes evident in the striking and unexpected experience of seeing Sable Island horses grazing in the dunes.



A shipwreck engulfed in sand (left) (Maritime Museum of the Atlantic 2014)
Sable Island horses walking on the dunes near East Light, Sable Island, 2014 (right)

New elements of architecture can serve as additions to Sable Island's collection of alien things; thus the landscape can be curated with historic wrecks, wildlife and human infrastructure. Each human intervention can anticipate and make proposals to the island's natural changes; leaving traces of their interactions.



Sable Island's short term memory is recorded in the sand. Grass records wind movement by bending into the sand (left), animals leave their footprints (middle) and even recent rainfall is recorded (right), Sable Island, 2014



The island's long term memory is recorded by buried artifacts, curated by erosion and deposition, Sable Island, 2014

Site and system analyses in this thesis are also inspired by those presented in *Soak: Mumbai in an Estuary* by Anuradha Mathur and Dilip da Cunha, and the *Barefoot Architect: A Handbook for Green Building* by John van Lengen. *Soak* suggests intentional integration of human habitation with the naturally dynamic environment of Mumbai. "Soak opens up new directions for the science of cities. . .The work of Anuradha Mathur and Dilip da Cunha inspires us to create a wetter, softer, science of the city. . ." (Mathur and da Cunha, Foreword) It uses innovative representation style to analyze technology, ecology, geology, geography and other layers of site information, in legible, data dense, artistic drawings. Site analyses for this thesis will learn from *Soak* to produce clear and thorough analyses of Sable Island.



Layers of site data analyzed in *Soak* (Mathur and DaCunha 2009, 56)

The *Barefoot Architect* promotes low-tech design solutions for coping with nature's forces in various global climates. "The manual is meant to answer the realistic challenges in present day construction, and to suggest practical solutions by combining traditional and modern techniques". (Lengen 2008) It uses simple line drawings to explain building systems and construction details. The thesis uses similar simple line drawing techniques to explain the various systems of Sable Island, and to express elements of the design.

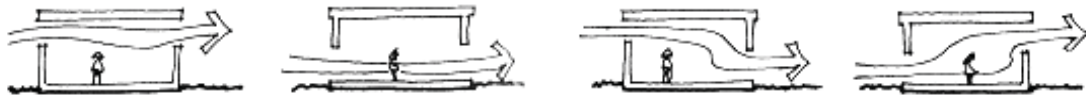

Drawings of ventilation strategies in *The Barefoot Architect* (Lengen 2008, 48-49)

Careful site analysis inspired by McHarg and Mathur and da Cunha provides a framework for understanding the dynamic natural laws governing life on Sable Island. Those laws form the basis for creating a design strategy inspired by McHarg and Van Lengen which integrates architecture *with* its ecosystem. Discrete and tactical design strategies inspired by Descombes will highlight opportunities for new infrastructure to recover sites, sculpting a new way for people to interact with the island's dynamic landscape. New infrastructure, while reconciling the past, will encourage future inhabitants to better understand and appreciate their connection to Sable Island and its natural processes.

I knew well that no house should ever be on a hill or on anything. It should be of the hill. Belonging to it. Hill and house should live together each the happier for the other. That was the way everything found round about was naturally managed except when man did something. (Wright 1943, 168)

CHAPTER 2: DESIGN

Site Dynamics and Program

Analyses of Sable Island's vegetation, historic position, current topography and climate data help determine where the landscape is most stable. Understanding why and how landscape changes occur make it possible to select optimal locations for development.

Sable Island's ecosystem is a cycle of cause and effect scenarios where destruction and creation happen simultaneously. Wind and waves move and sculpt sand while vegetation works to build it into stable mounds and dunes.

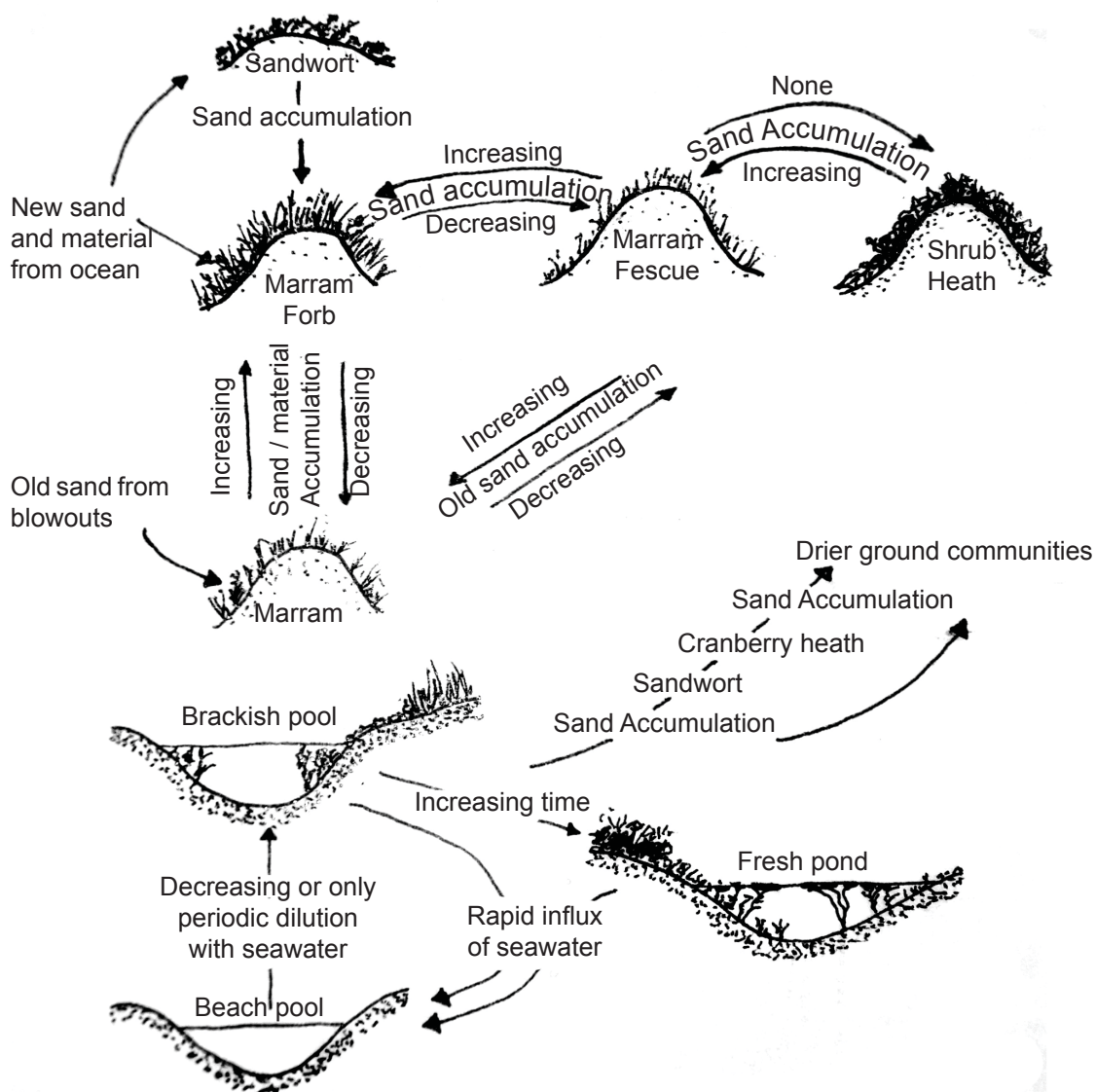

Diagrams of sand, water, and vegetation relationships on Sable Island redrawn from (Catling, Freedman and Lucas 1984)

Nearly half of the island is un-vegetated sand: beaches, bald dunes and roads. These areas are very tolerant for human use, but change constantly with wind, tide and currents. Due to their transient nature un-vegetated areas are not suitable for building infrastructure, but are ideal for runways, roads and paths.

The salt water of the Atlantic Ocean periodically floods inland areas. Forming bodies of salt water, like Lake Wallace in the centre of the island. (Muisse 2011) Fresh water ponds emerge from the island's aquifer lens. Rain water enters the sand and flows to sea level where its less dense chemistry allows it to collect above the denser salt water. Fresh water slowly diffuses into the salt groundwater. (Hennigar 1976)

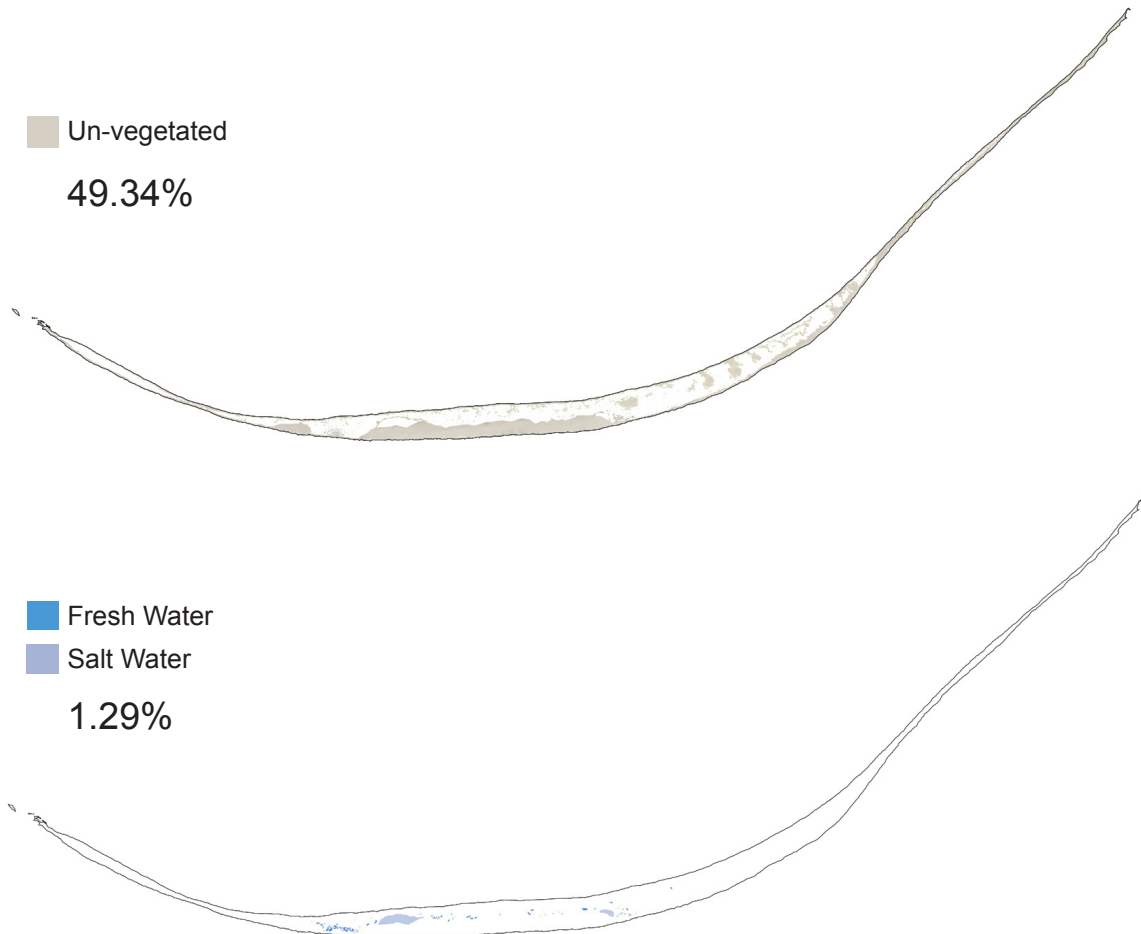

Land-cover diagrams (data from Muise 2011)

Sandwort is a pioneer plant that inhabits dry conditions on beaches. It tolerates limited salt water flooding and stabilizes sand with its shallow root mesh. The plant collects windblown sand into mounds up to 1 metre high; providing dry habitat for marram grass to grow. (Pavia and Lorient 2013) (Catling, Freedman and Lucas 1984)

Sandwort habitat is not recommended for infrastructure development because it populates changing edges that are often flooded by the ocean. (Muisse 2011)

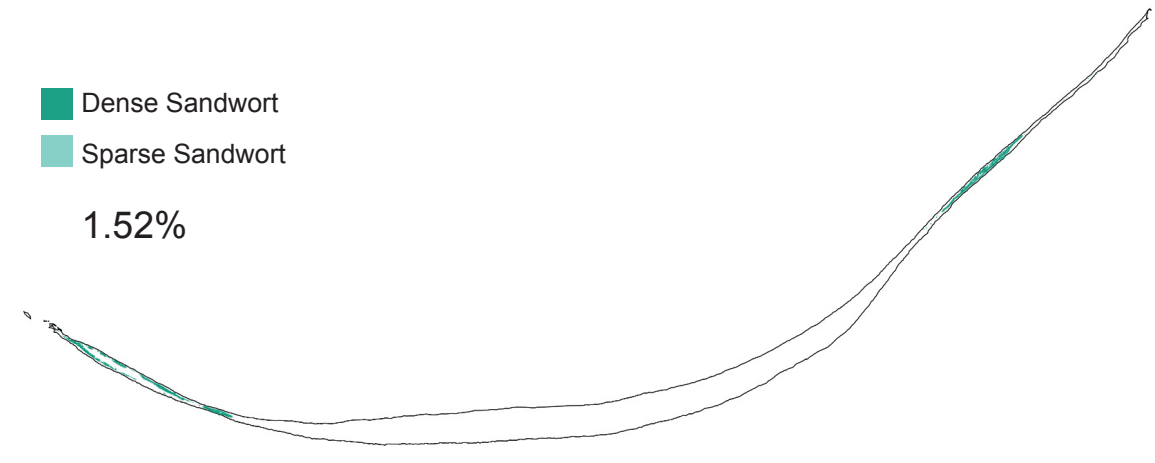

Land-cover diagram (data from Muise 2011)

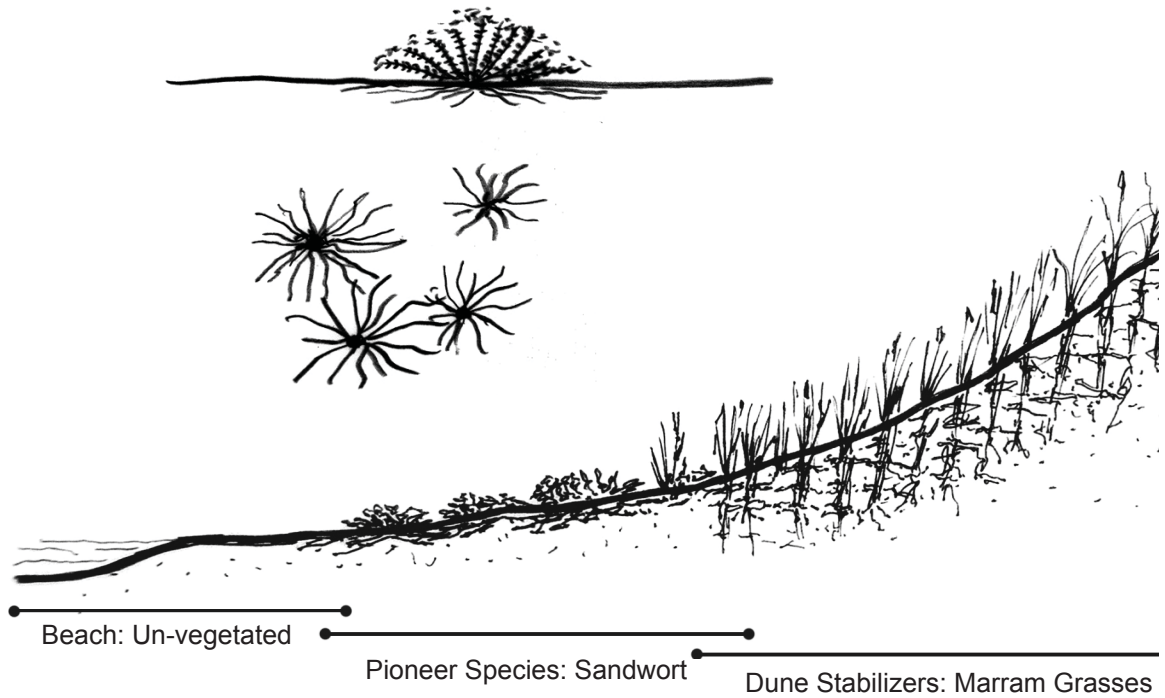

Sandwort diagrams (Data from Pavia and Lorient 2013 and Catling, Freedman and Lucas 1984)

Marram grasses have deep, dune stabilizing root structures; growing in dry areas, their blades catch wind-blown sand to form dunes. It grows through accumulating sand forming annual stabilizing root mats. Marram grass is easily killed when trampled, leading to aggressive dune erosion. Human activity should not occur in dune habitats to avoid damaging protective dune systems. (Gillings 2013) (Catling, Freedman and Lucas 1984)

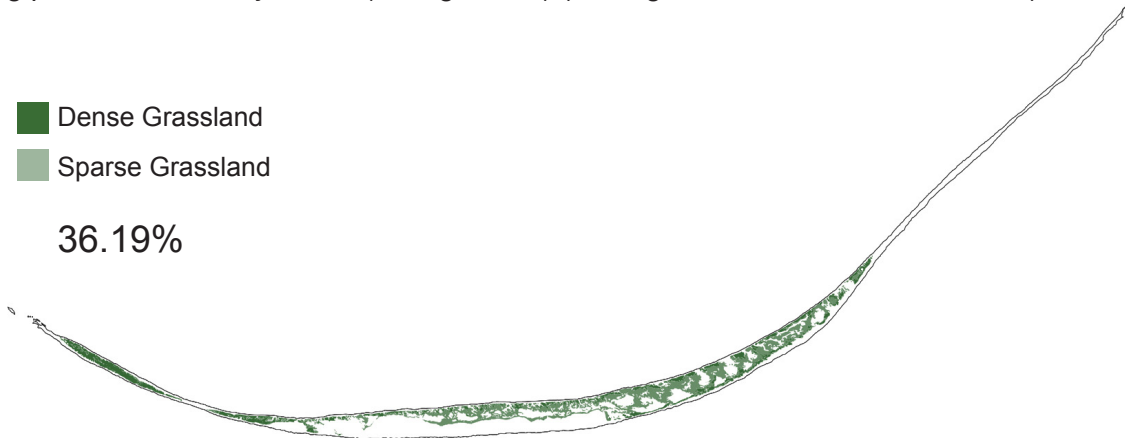

Land-cover diagram (data from Muise 2011)

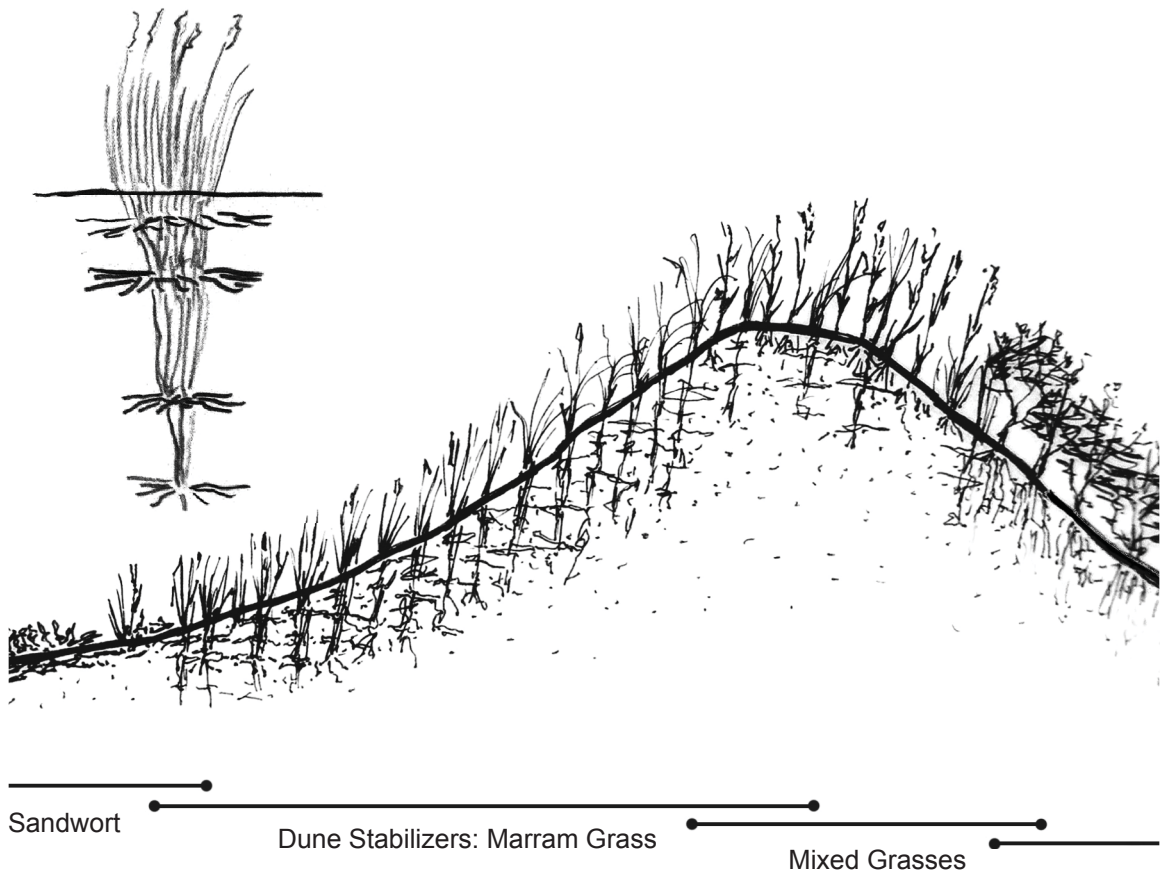

Marram diagrams (Data from Pavia and Lorient 2013 and Catling, Freedman and Lucas 1984)

Heath grows in weather protected environments between well established dune systems and often near fresh water ponds. Its habitat occurs in well stratified landscapes that have grown for a long time without significant change. Their dense roots are strong and tolerant to trampling; heath habitats are ideal for human habitation and infrastructure development. (Emily deCamp Herbarium 2013) (Catling, Freedman and Lucas 1984)

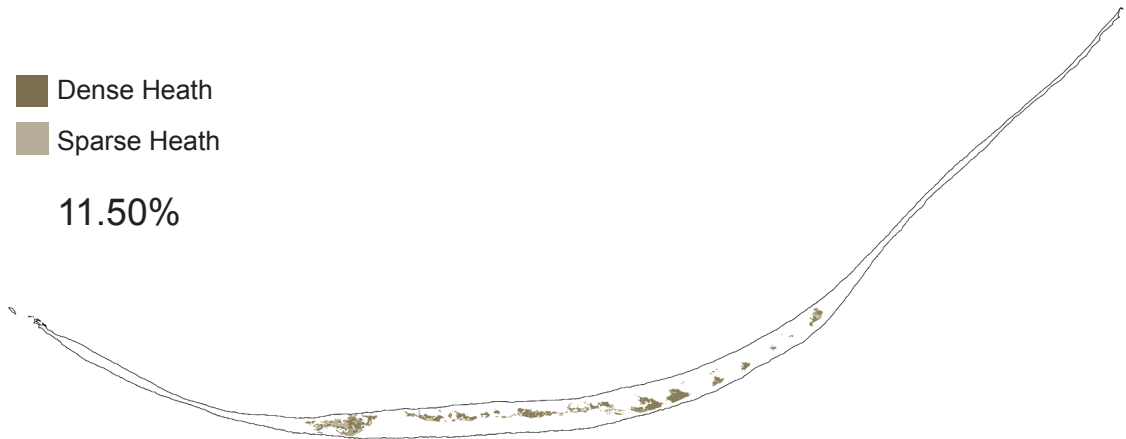

Land-cover diagram (data from Muise 2011)

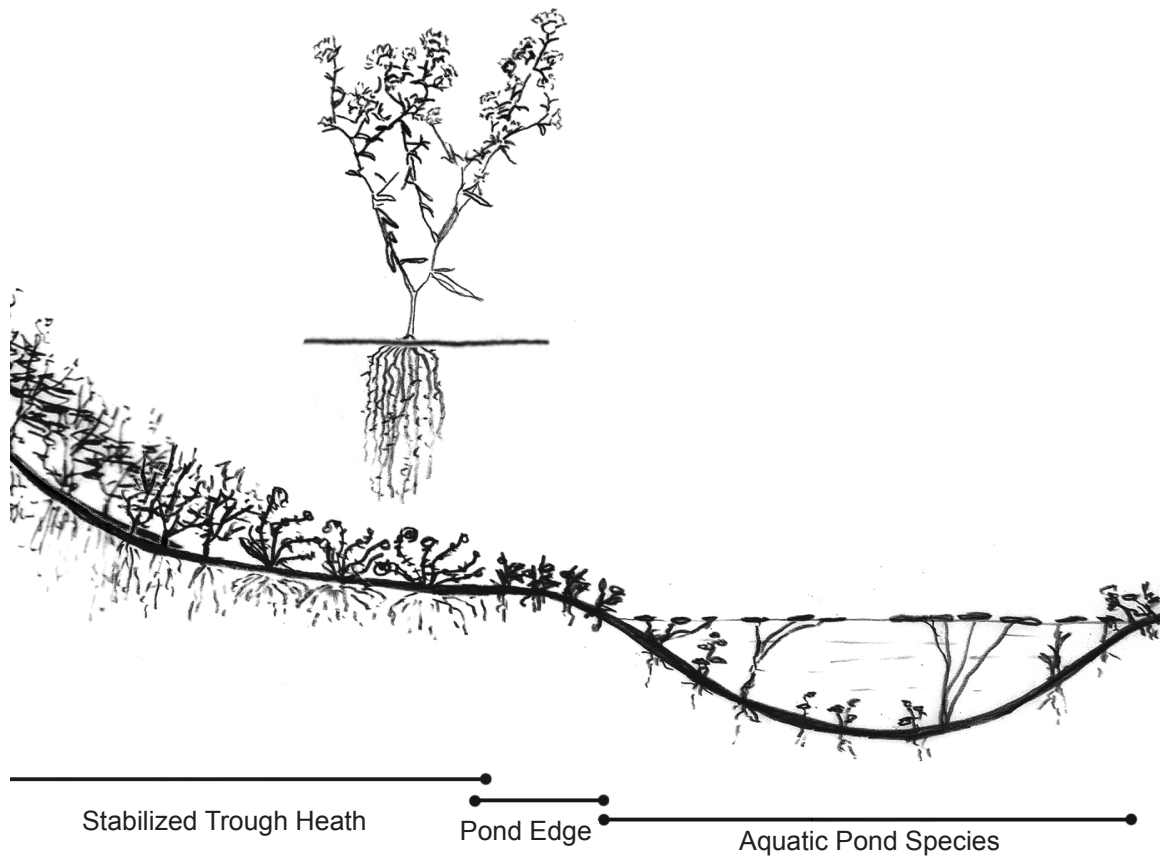

Heath diagrams (Data from Pavia and Loriente 2013 and Catling, Freedman and Lucas 1984)

Sable Island is subject to ocean currents which erode and deposit sand. Nestled between the warm Gulf Stream and cold Labrador Current, the Sable Island Gyre is formed. The gyre forms cyclical currents around the island, which are more responsible for confusing mariners than moving sand, though it does affect the way local currents flow around the island. Those local rip, longshore and tidal currents gradually move sand, but storm currents and surges are most responsible for drastic landscape changes (DeVilliers and Hirtle 2004, 62-65).

Winds cause sediment transport on Sable Island, significantly changing the landscape. Prevailing wind from the west gradually moves sand and strong storm winds make sudden changes to land formations. Storms approach predominantly from the Northwest in winter and Southwest in the summer. Winds with an eastern component are rare and are usually less powerful (Hennigar 1976, 10).

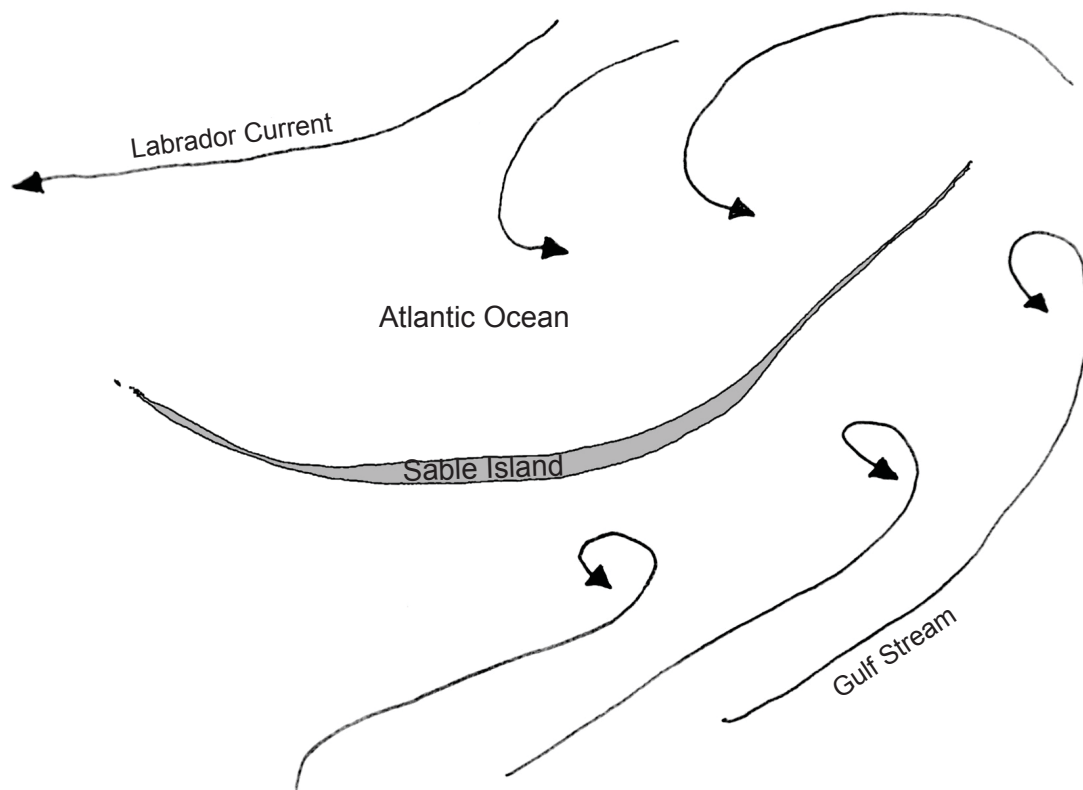

Sable Island Gyre redrawn from (DeVilliers and Hirtle 2004)

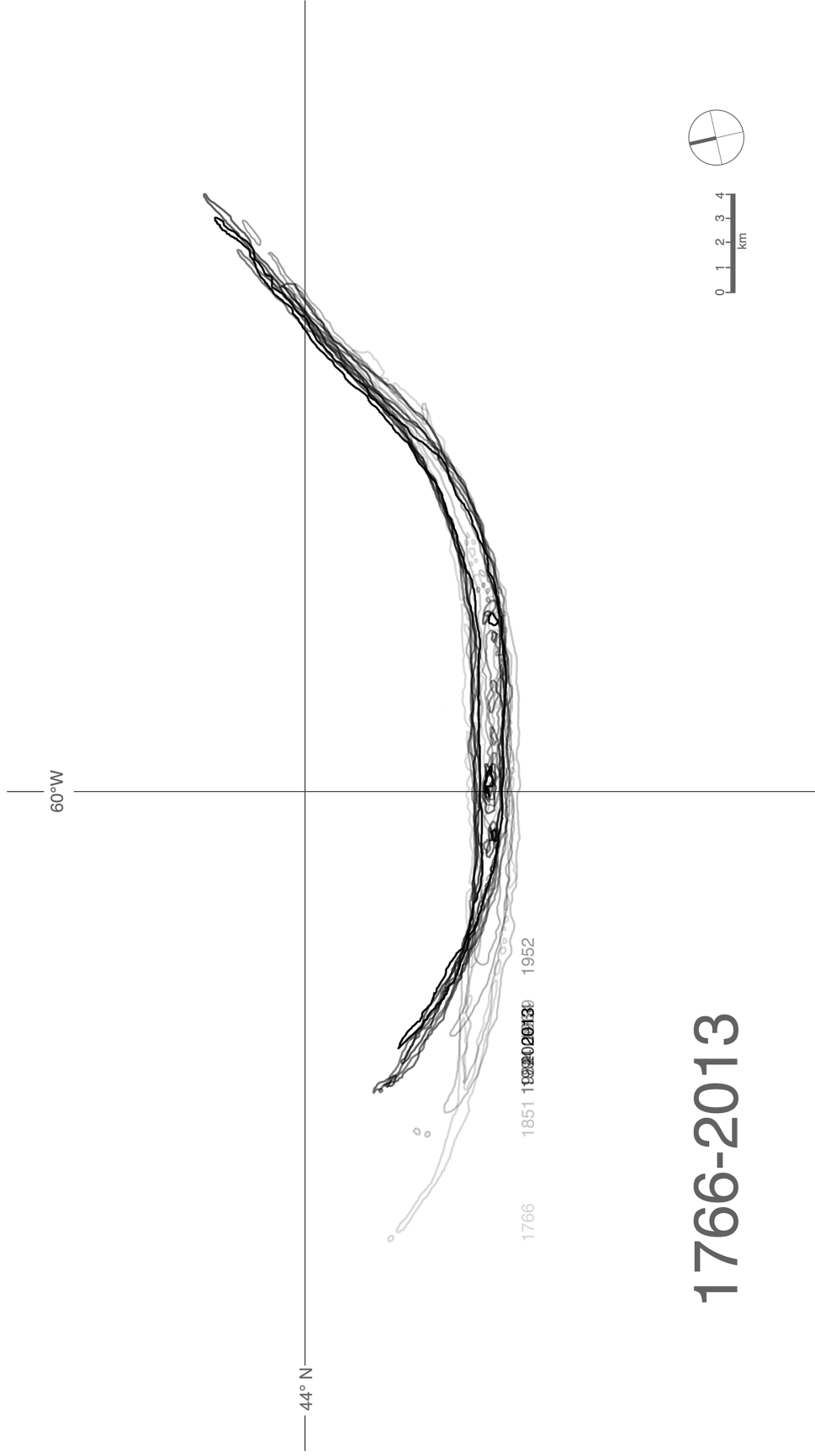

1766-2013

Data for historic mapping diagram collected from: Cameron, The Shifting Sands of Sable Island. Geographical Review, 1965 (475-6), and recent satellite data. The sources were compiled and overlaid according to David H. Gray's theory expressed in his article "Where has Sable Island Been for the Past 200 Years?"

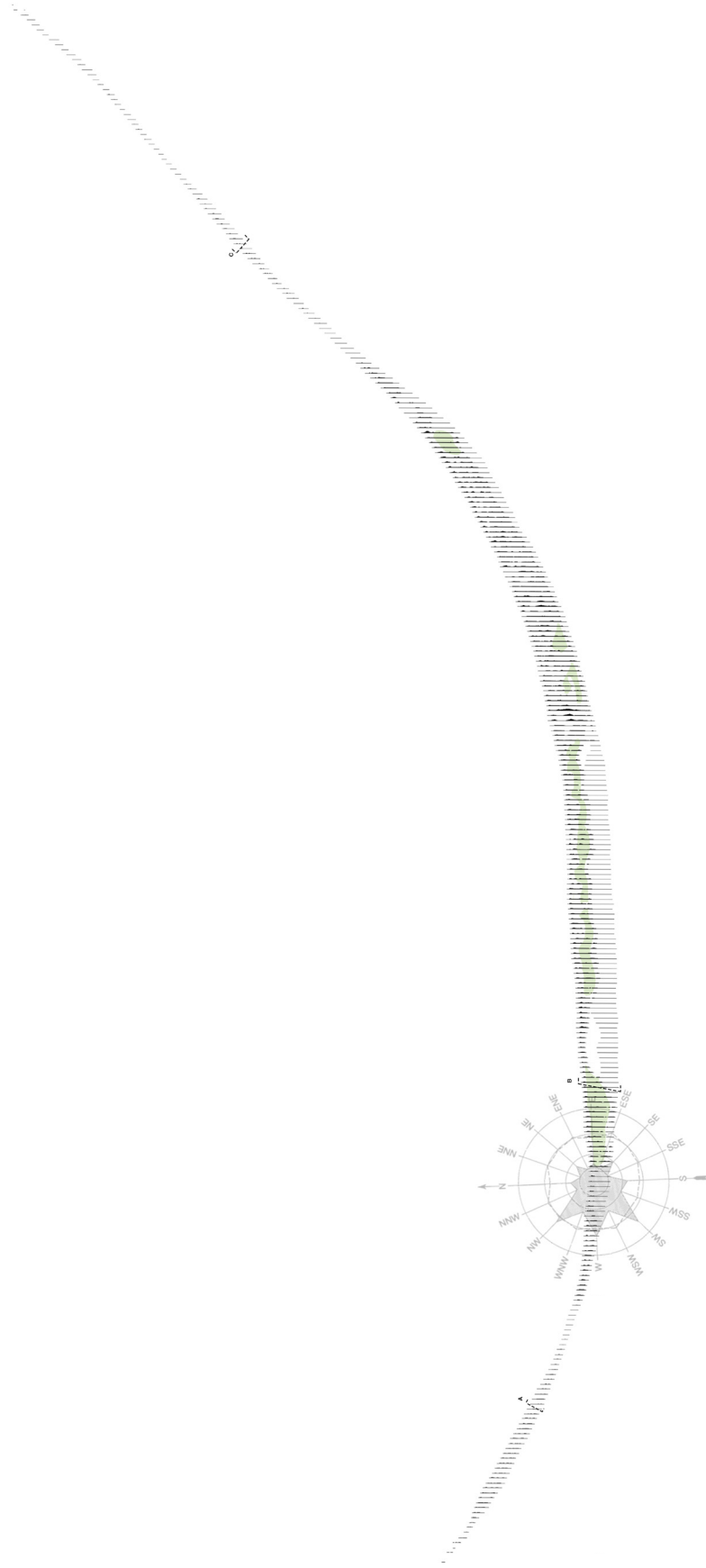

This topography plan demonstrates variations in landscape by cutting sections every 100 metres across the island. Light green highlights dune stabilized areas least likely to be changed by wind and storms. A wind rose is overlaid showing prevailing wind directions in relationship to the topography. (Hennigar 1976) Topography data was collected from *Sable Island, Nova Scotia: 2009 Topography and Land Cover Atlas*. (Muisse 2011)

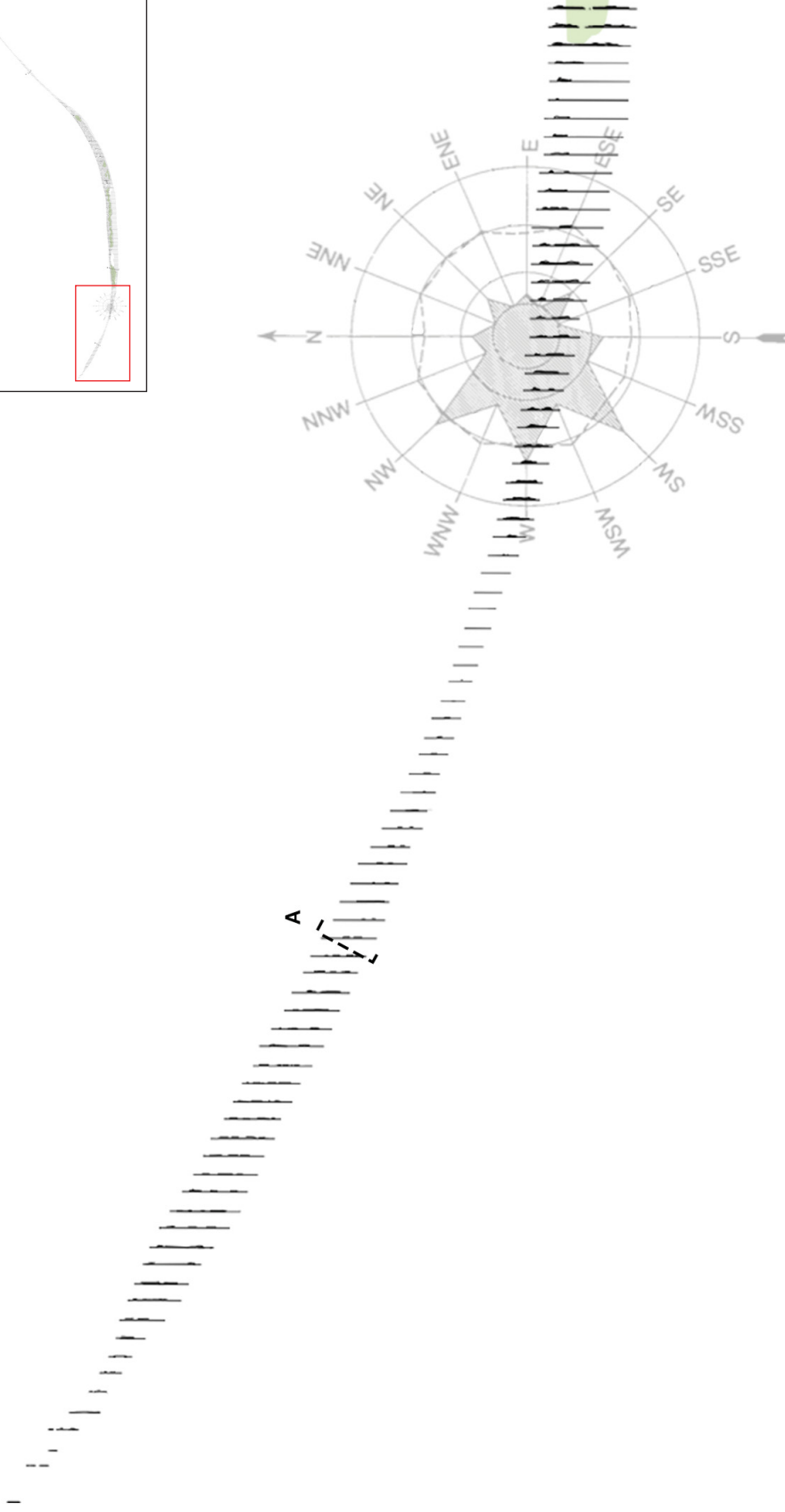
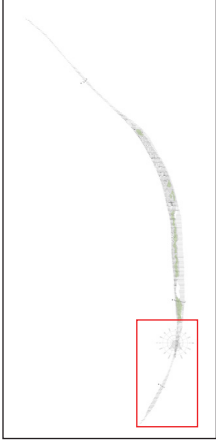

The West Spit, historically the most changed part of the island (see illustration on page 24), is very low and exposed. It is the first landfall point for storms and winds. Very little protected dune habitat exists here. If development occurs here it should be easy to relocate in case of major landscape change. (Hennigar 1976) (Muisse 2011)

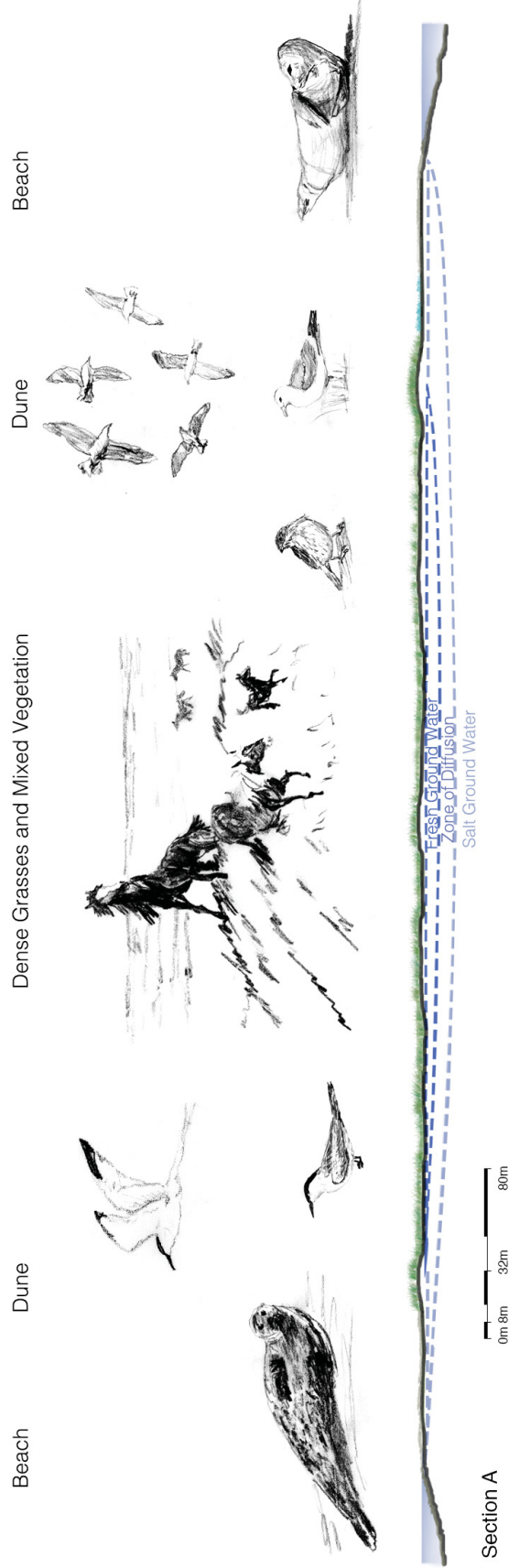

Section A is vegetated with pioneer plants and grasses that form low dune profiles. Little fresh ground water is accumulated during rains. Seals populate the beaches, horses graze in the dunes and birds are plentiful. Researchers and tourists observe wildlife here. (Hennigar 1976) (Muise 2011)

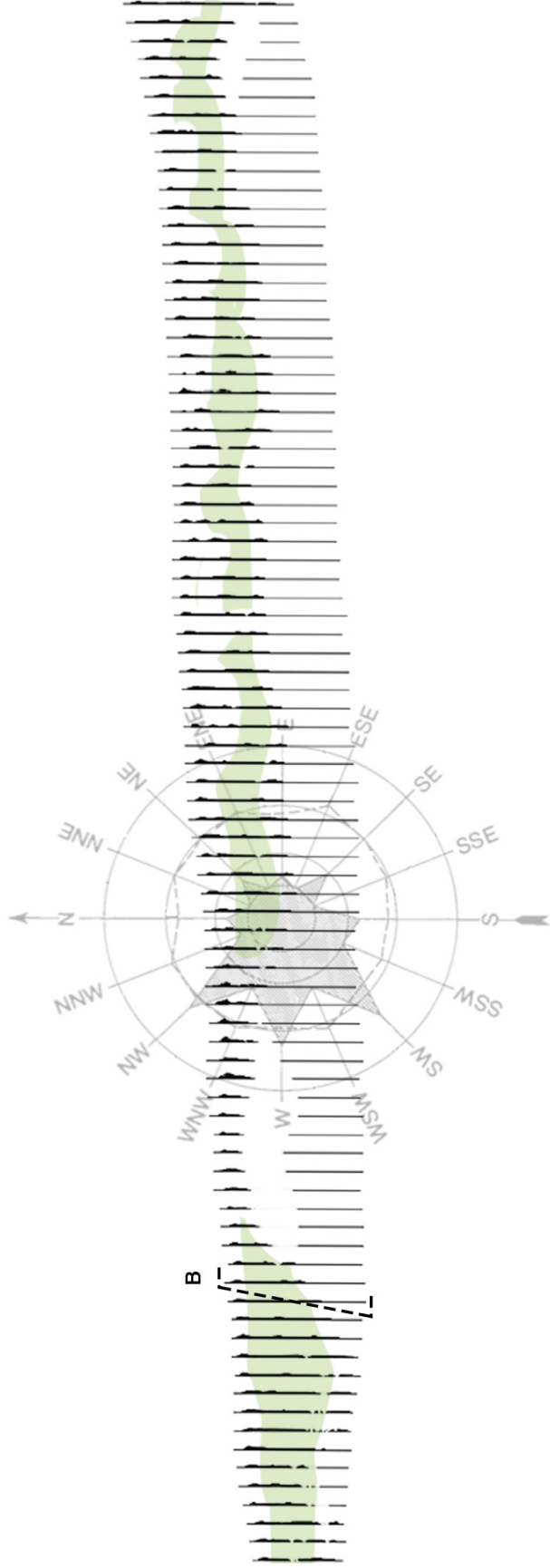
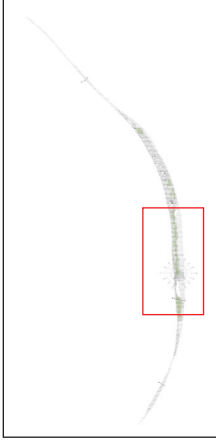

The centre of the island is historically the most stable part of the island (see illustration on page 24). It has strong constant dune systems. On an West to East axis, the island itself breaks prevailing wind speeds. North and South dunes protect the inland trough from storm winds. The widest stable habitat at section B is the most tolerant site; the landscape here is slow to change and suitable for development. The trough overlooking the wide South beach is also well protected, but is so narrow that potential dune blow outs and wash outs could undermine developments. Any infrastructure there would require a resettlement plan. (Hennigar 1976) (Muisse 2011)



Beach

Dune

Stabilized Trough

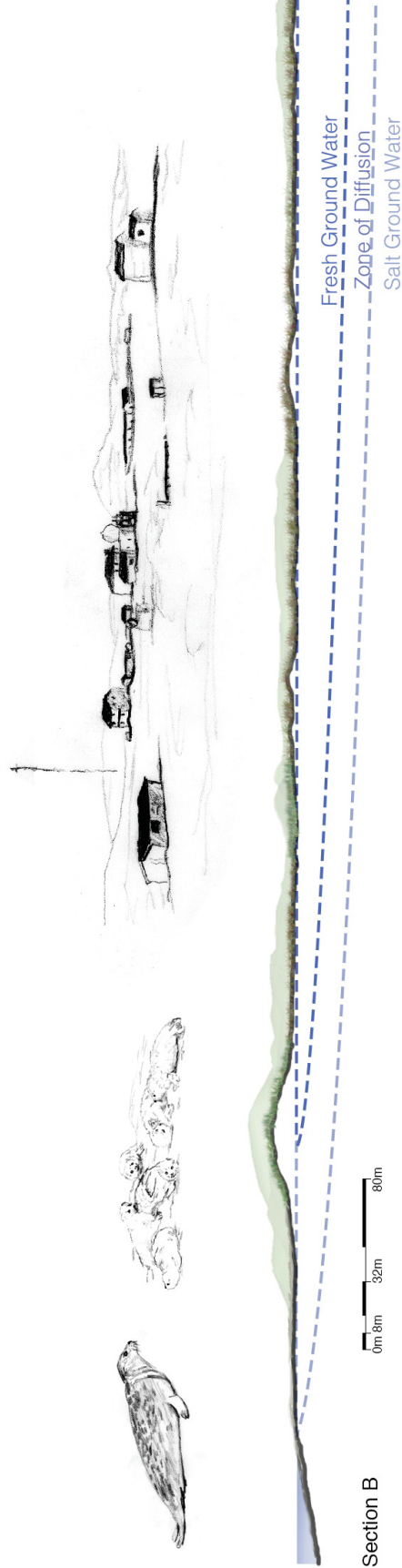

Section B cuts through the widest stable landscape on the island. The weather protected landscape is used by seals to mate and raise their young in the winter. It is also home to most of the existing human settlements. Its width provides settlements with a buffer from changing dune lines. (Hen-nigar 1976) (Muisé 2011)



Stabilized Trough



Dune



Beach

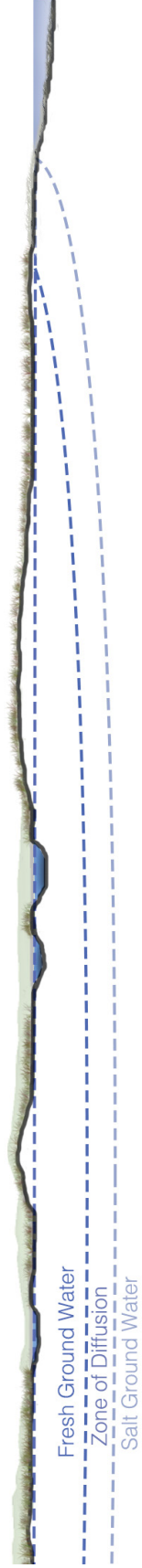

Section B continued

Section B's protected habitat is ideal for horses raising their young and for nesting birds. Wildlife is vibrant near fresh water ponds that surface where the island's topography drops below the fresh ground water line. (Hennigar 1976) (Muise 2011)

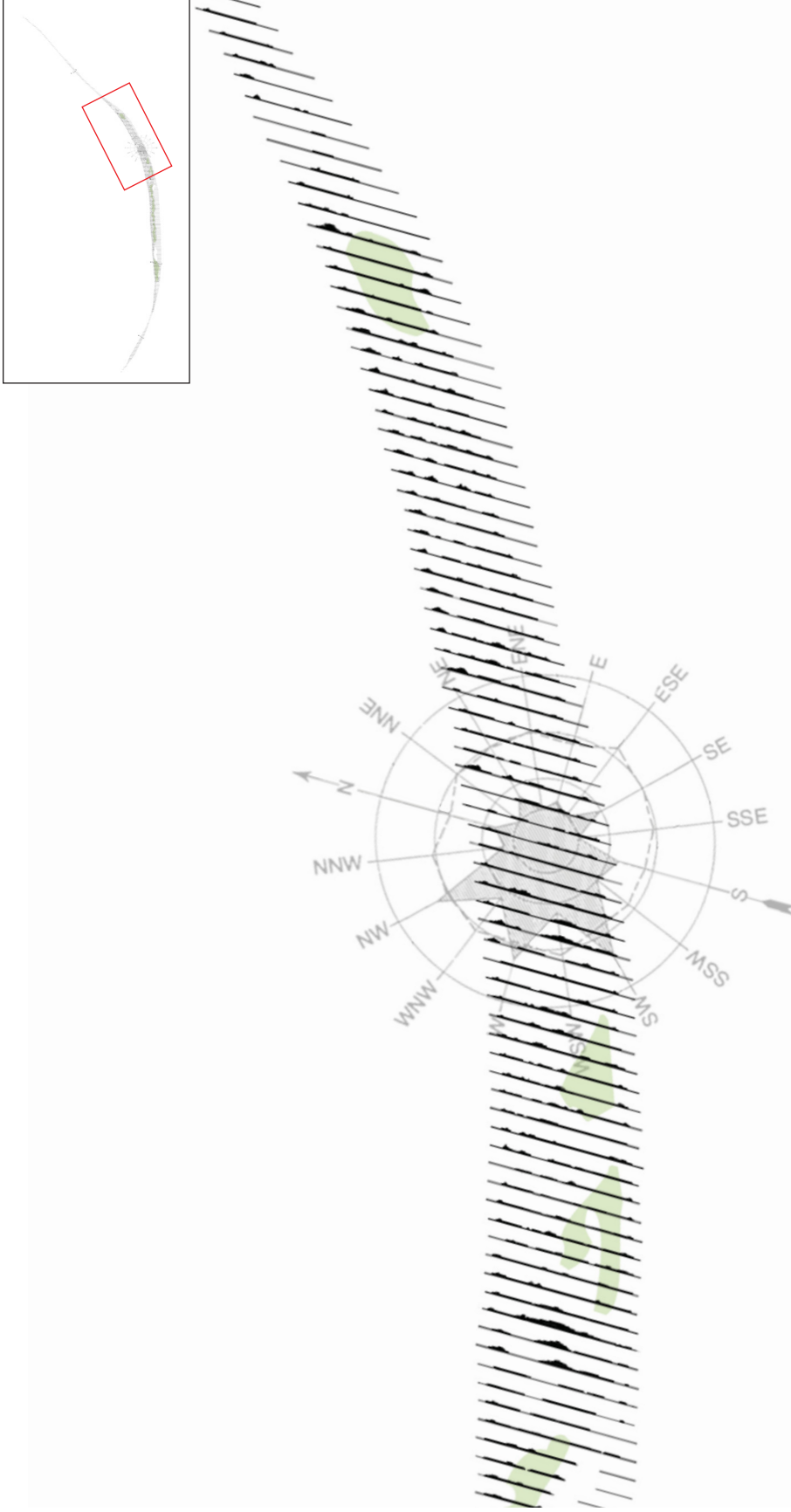

As the island turns North the prevailing winds make landfall with full strength, moving sand and creating a turbulent terrain. Bald Dune, a massive accumulation of windblown sand is the highest point on the island and an important tourism site as it provides excellent views of the island. A few areas are protected by dune systems, but could easily be breached during strong winds. Any development in these areas should be easy to relocate in the event of major terrain changes. (Hennigar 1976) (Muisse 2011)

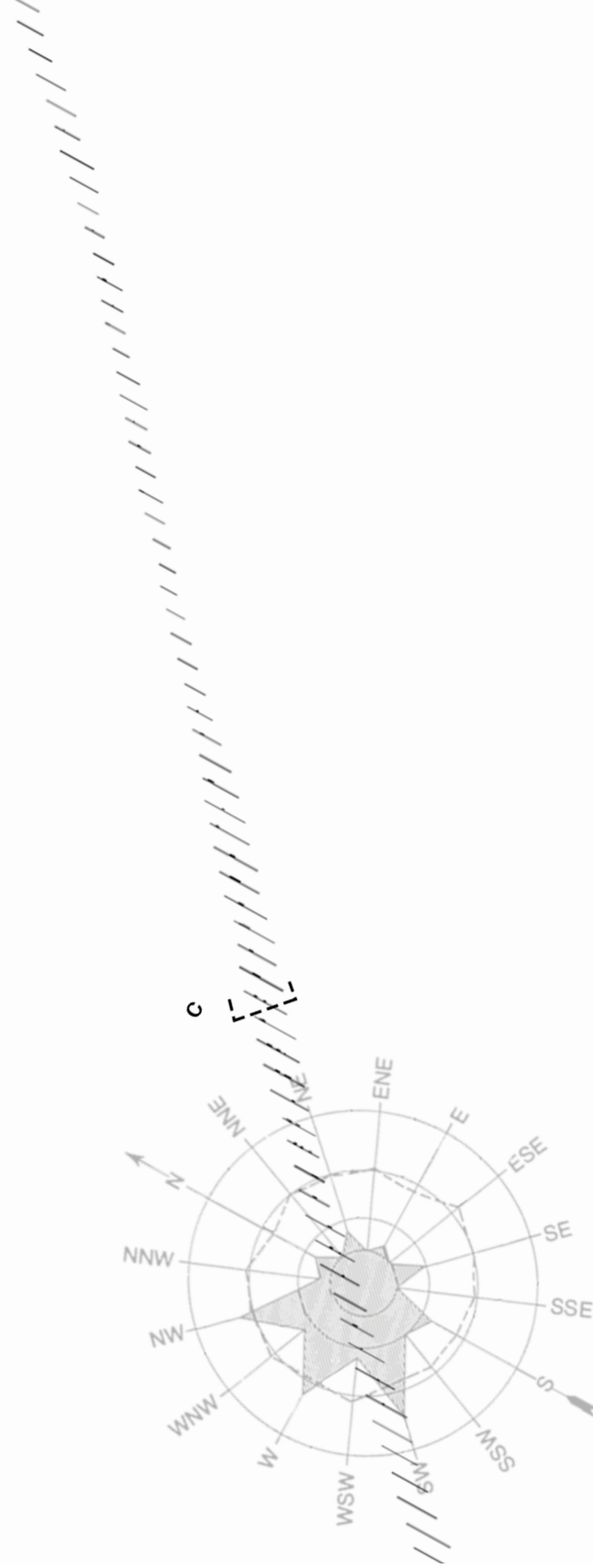
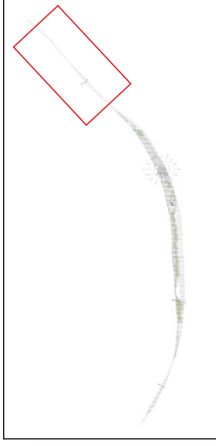

East Spit is very low and exposed. It is one of the most frequently changed habitats (See illustration on page 24). Very exposed to high winds and wash over from storms, the landscape is not fit for development. (Muisse 2011)

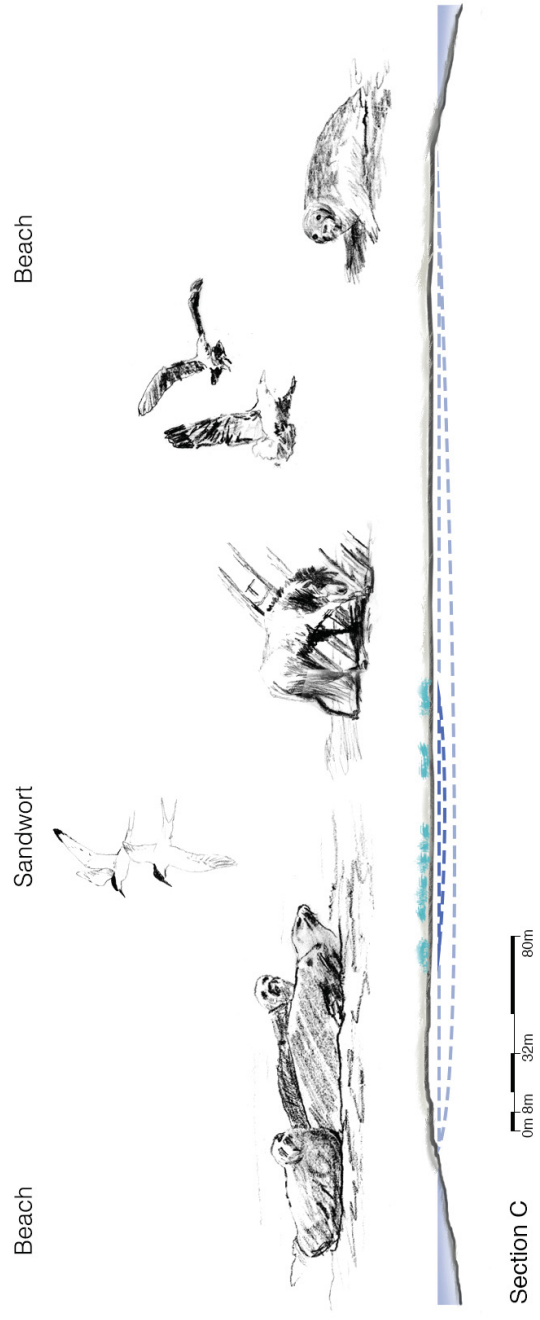

Section C

Section C shows the most exposed habitat on Sable Island. Horses venture to this harsh landscape to scratch against exposed debris or to eat washed up seaweed. Birds hunt on the spits and seals use them for basking. Only Sandwort can grow here due to frequent salt water flooding. This area, though rich with life, is only inhabited temporarily and people should only use it for hiking and short research trips. (Muise 2011)

Understanding access and activity on the island helps determine what infrastructure is necessary. Migrating birds and chartered aircraft access Sable Island by air. The vulnerable Ipswich Sparrow and endangered Roseate Tern migrate to and from their overwintering grounds during spring and fall to breed on Sable Island during summer. (DeVilliers and Hirtle 2004, 208-210) Researchers and tourists from around the world can travel to study and experience Sable Island.

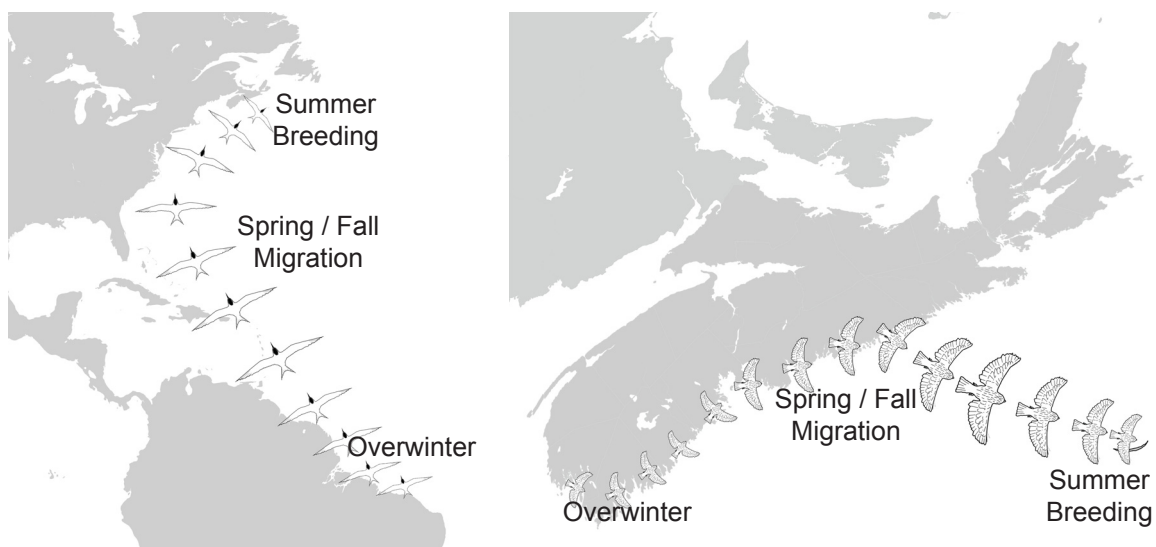

Roseate Tern migration (left), and Ipswich Sparrow migration (right)
(Base maps from Wikimedia Commons 2013a, and Wikimedia Commons 2013b)



Researchers and tourists from around the world come to study and experience Sable Island (Base map from Wikimedia Commons 2013a)

Wildlife, tourists and supply ships access Sable Island by sea. Great White Sharks migrate to and from their overwintering waters during spring and fall to feed on Sable Island's Grey Seal population in the summer. Seals bask on the beaches and hunt for fish around the island most of the year and come inland to breed during winter. (DeVilliers and Hirtle 2004, 196-198)

Tourists arrive on expedition ships that anchor offshore; they land via Zodiac and take guided day tours on the island. Tour groups can be kept small and dispersed to different parts of the island to avoid disturbing wildlife.

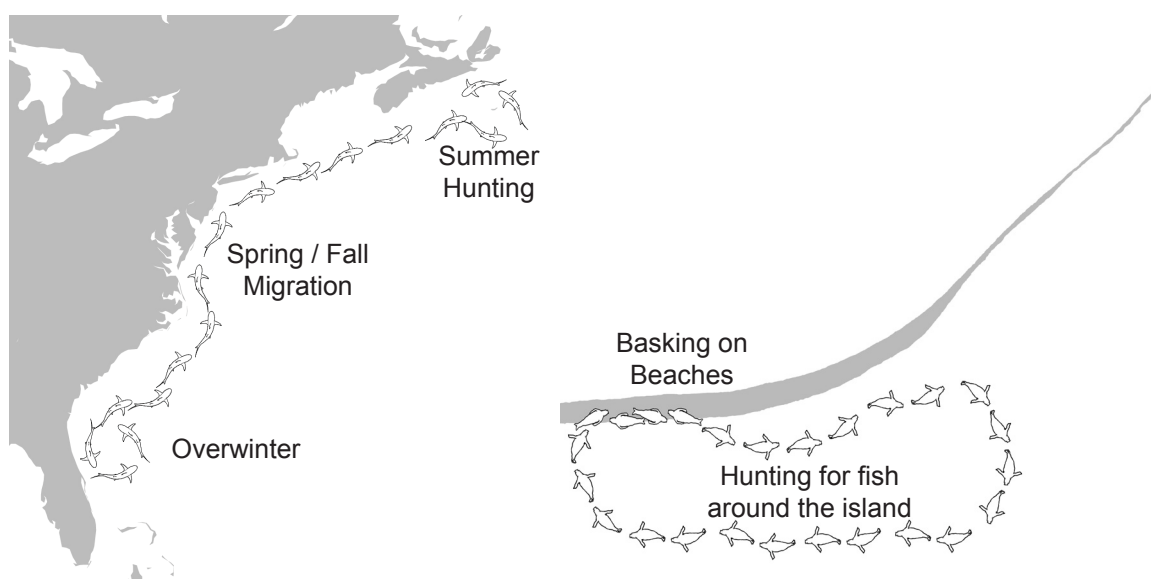

Great White Shark Migration (left), and daily seal habits (right)
(Base maps from Wikimedia Commons 2013a, and Muise 2011)

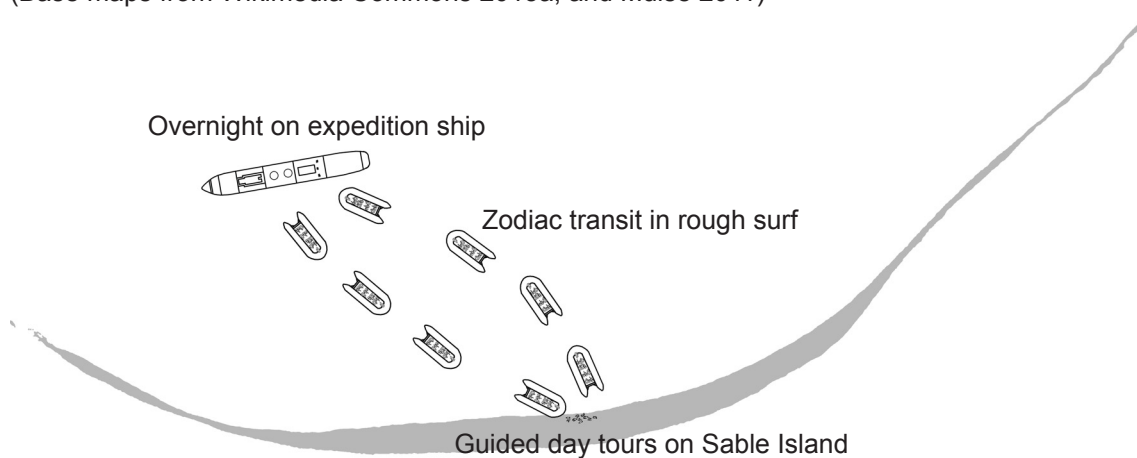

Guided day tourists travel to and from the expedition ship (Base map from Muise 2011)

Wildlife and people move between habitats on the island. The wild horses graze in the dunes and heath during the day and gather in groups in lee of the dunes to sleep and weather storms. People use all terrain vehicles to travel and carry supplies between beaches and Main Station. Supplies are delivered via landing craft on the North beach, and the South beach serves as a runway for planes (DeVilliers and Hirtle 2004).

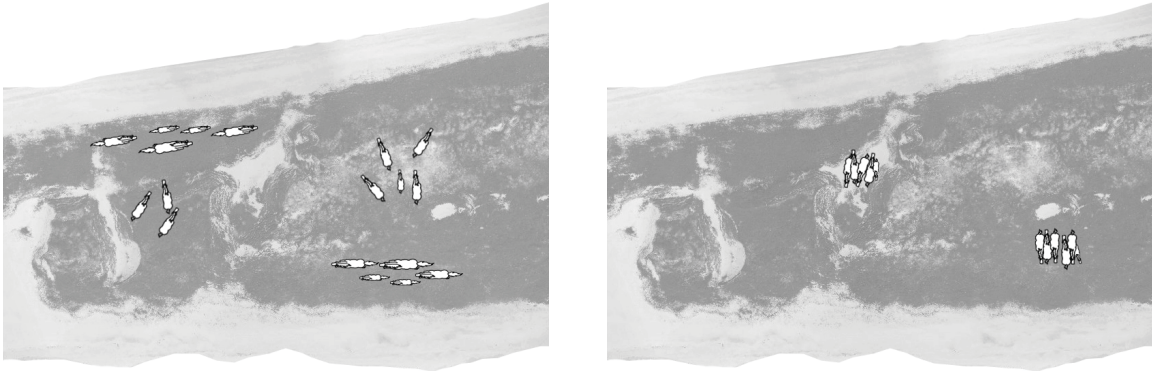

Horses grazing during the day (left), and horses gathered (right) (Base map from Muise 2011)

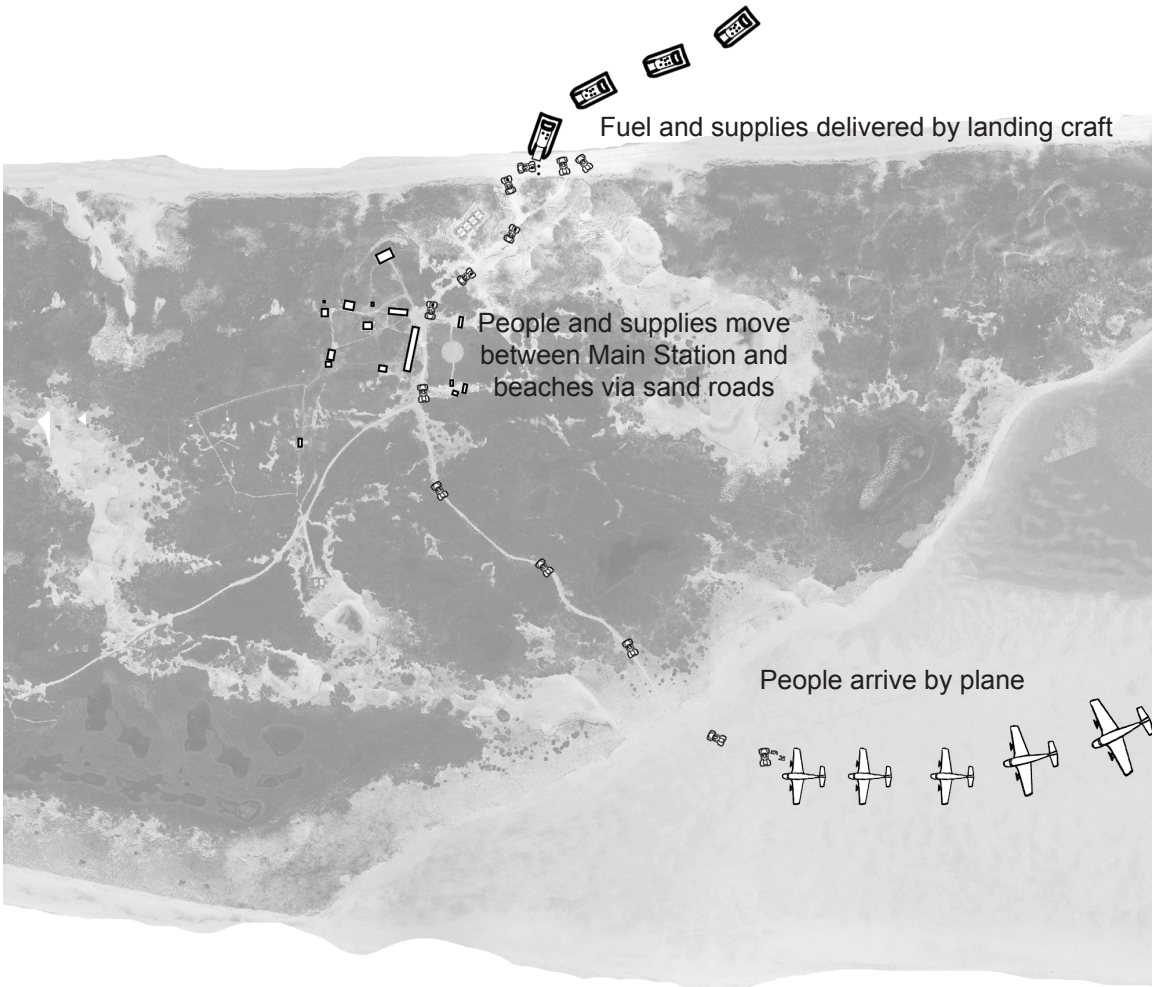

Transport of people and supplies on Sable Island (Base map from Muise 2011)

Reusing existing station areas reduces environmental impact because they are already connected to the beaches by sand roads and disruption of undeveloped habitat would not be required. Major development should be avoided in seasonal species at risk breeding habitats, but research and seasonal use shelters near these areas can be useful.

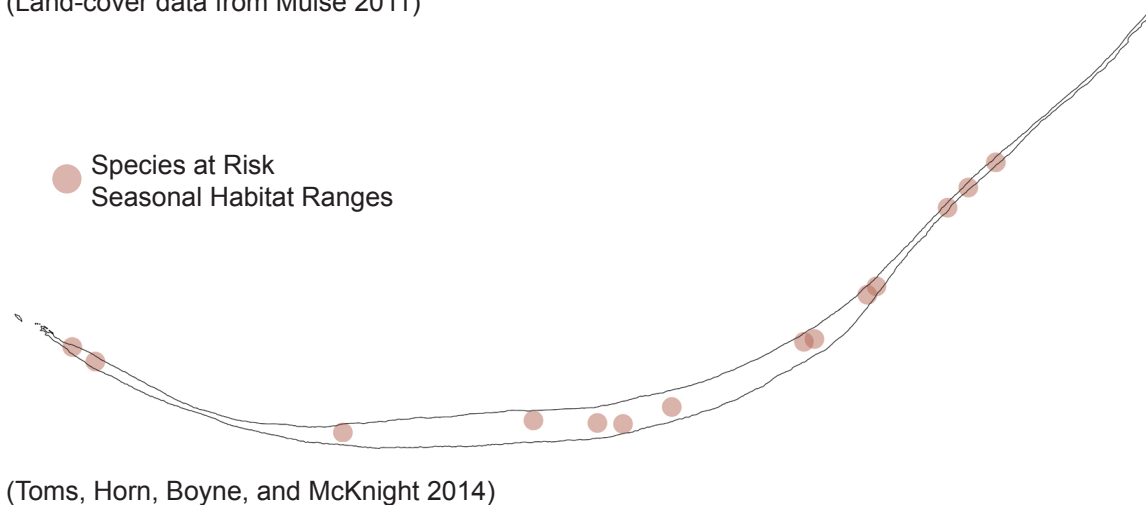
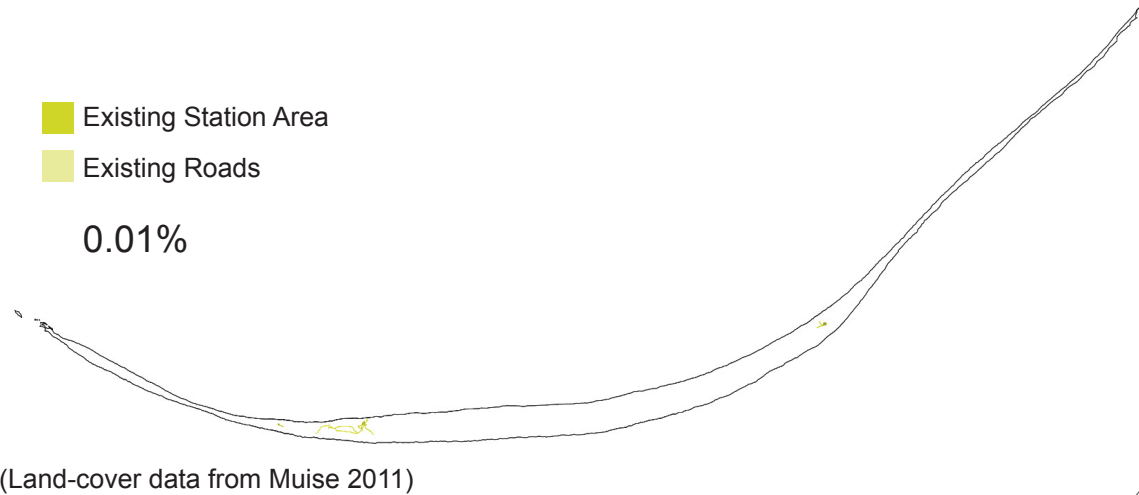

Site and ecosystem analyses provide guidelines for determining where to build National Park infrastructure on Sable Island: vegetation analyses show that heath habitat is strong and tolerant to human use, topography analyses identify dune protected environments and access and activity analyses define user requirements. The parts of the island where these attributes overlap with beneficial existing infrastructure, and avoid species at risk habitat, are ideal for development. A network of four architectural interventions built in these sites will provide safe refuge for emergencies across the island, eliminate the need to bring heavy camping equipment and provide all necessary National Park amenities.

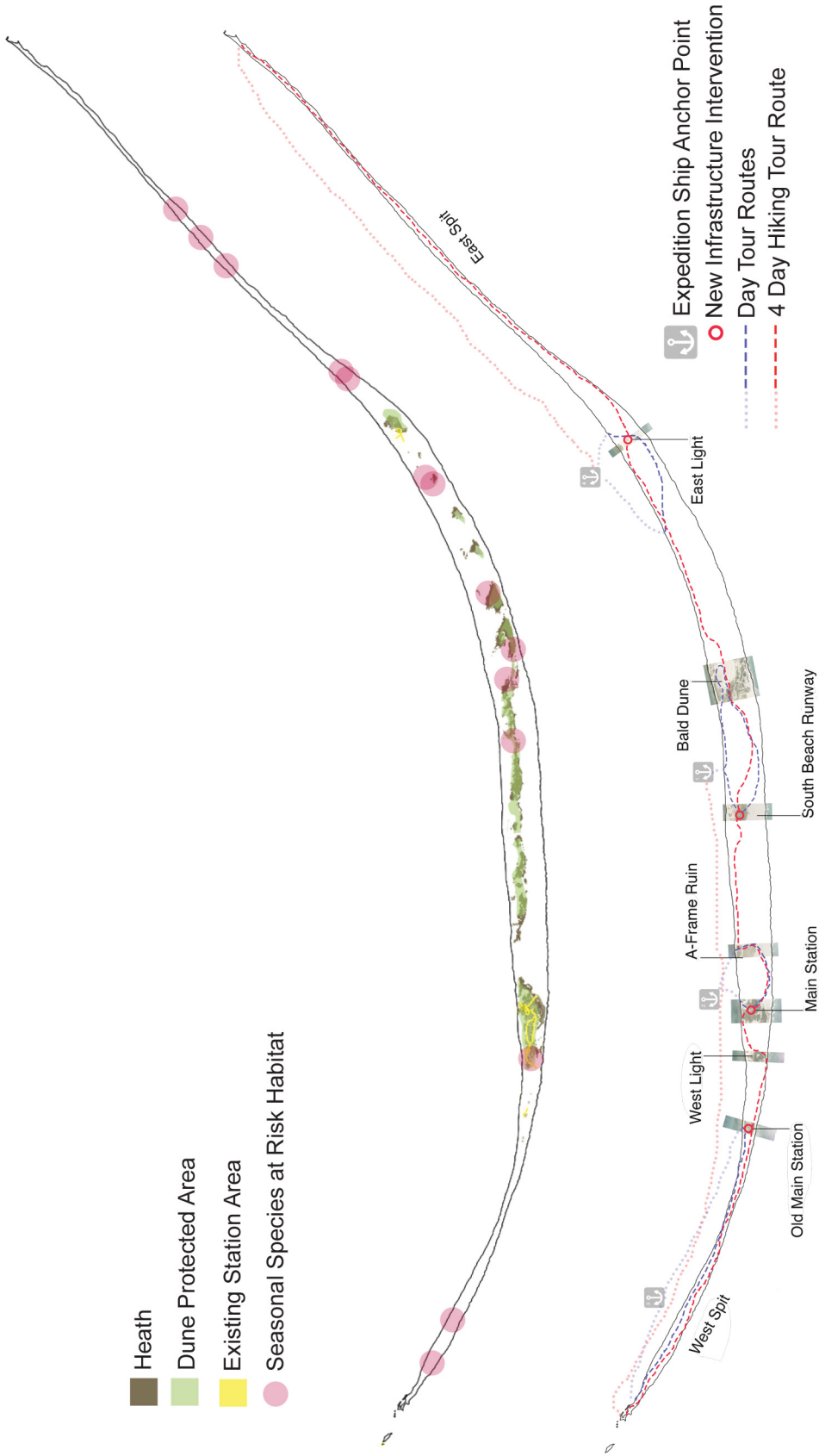

Overlapping data helps locate ideal sites for development. The proposed island plan links access points, sites of interest and new infrastructure. The network of architectural interventions and hiking paths allows researchers and tourists to explore the island and provides refuge points. The four strategically placed interventions inhabit very different landscape dynamics and require site specific design strategies. (Data for maps from Muise 2011 and Toms, Horne, Boyne, and McKnight 2014)

East Light and West Light Shelters

The intervention sites most prone to landscape change are East Light and Old Main Station. At the ends of the island's habitable range, the two sites once supported past incarnations of the East and West lighthouses. Introducing small shelters at these locations provides refuge for researchers and tourists exploring the Eastern and Western parts of the island and the Spits.

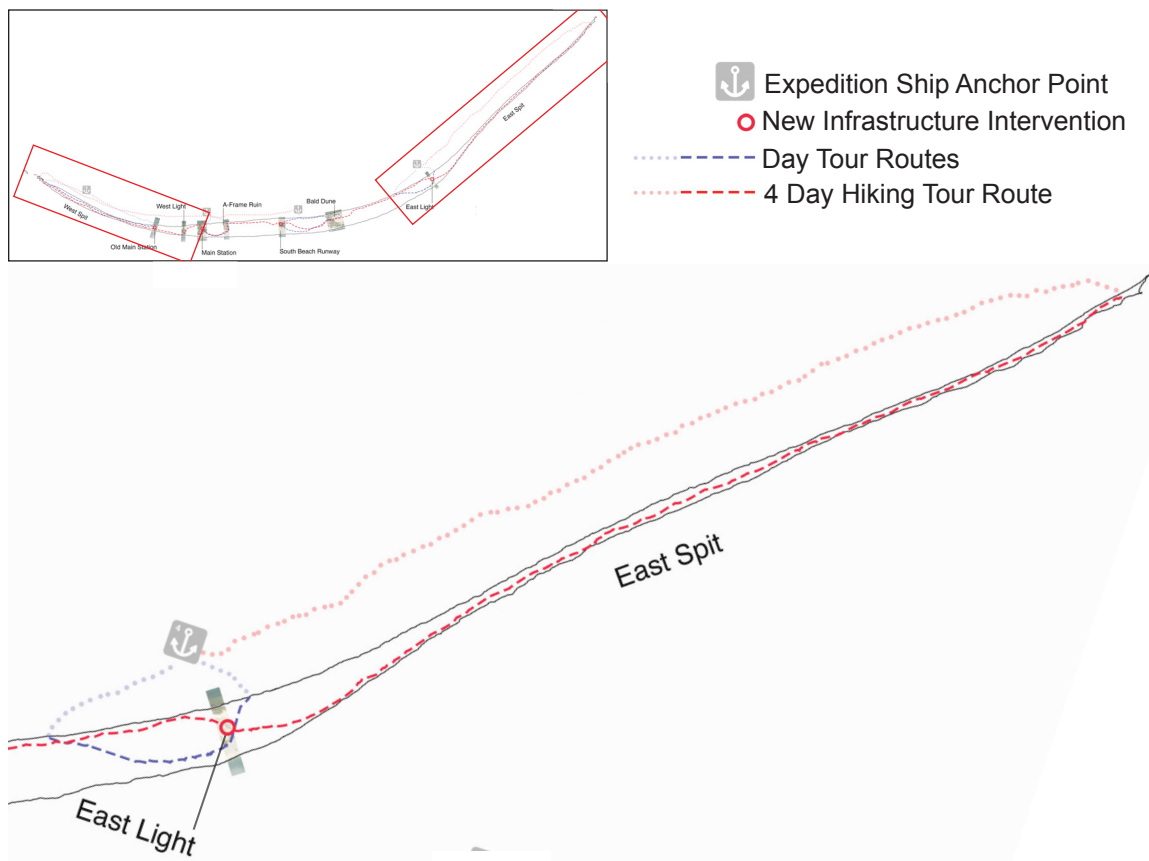

Enlarged island plan at East Light (Data from Muise 2011)

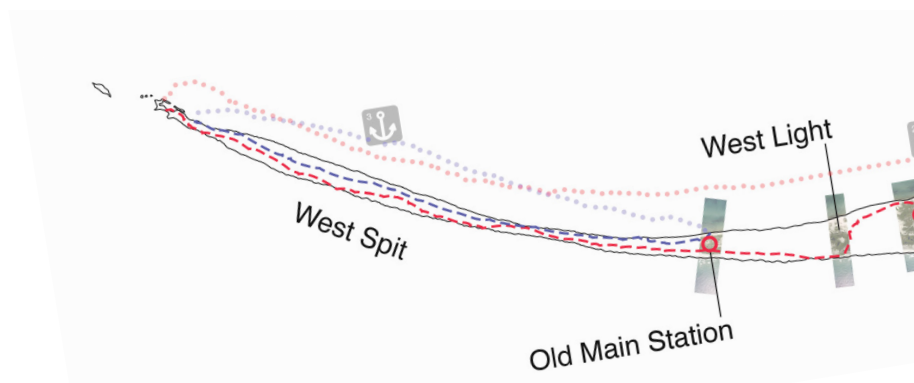

Enlarged island plan around Old Main Station (Data from Muise 2011)

Old Main Station is a fascinating site for tourists to visit. Loosely stabilized ground conceals and reveals a museum of artifacts from an old Main Station, naturally curated by wind and sand. Nearby, debris from the Nova Scotia Mines Camp is slowly covered by sand where it was abandoned. Environmentally harmful substances like plastics and fibre-glass litter the landscape.



43% Dense Grassland

19% Sparse Grassland

38% Un-vegetated

Land-cover (images and data from Muise 2011)











Wildlife grazes around exposed artifacts at Old Main Station (left), photograph from Parks Canada
Seals wean their pups near old ruins (right), Sable Island, 2014



Debris from dismantled settlement is being buried by sand, Sable Island, 2014



-  Ruins
-  Structure
-  Structure of concern
-  Proposed new structure
-  Road
-  Road restored to nature
-  Hazardous debris field
-  Remediated land

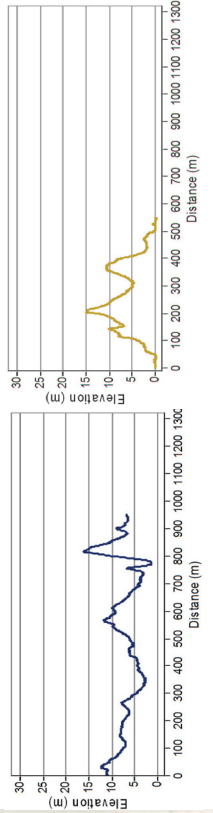
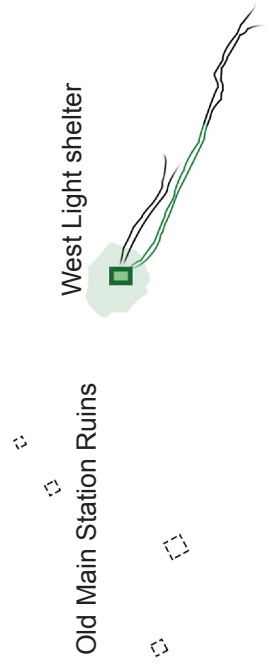

The adaptable "West Light Shelter" will be placed here, not far from where a previous west light stood. It will replace the debris from the Nova Scotia mines site, to remediate and take advantage of the dune protected position overlooking the ruins of Old Main Station. The shelter will be a refuge for tourists, and a remote station for researchers. (Data, sections and base map from Muise 2011)

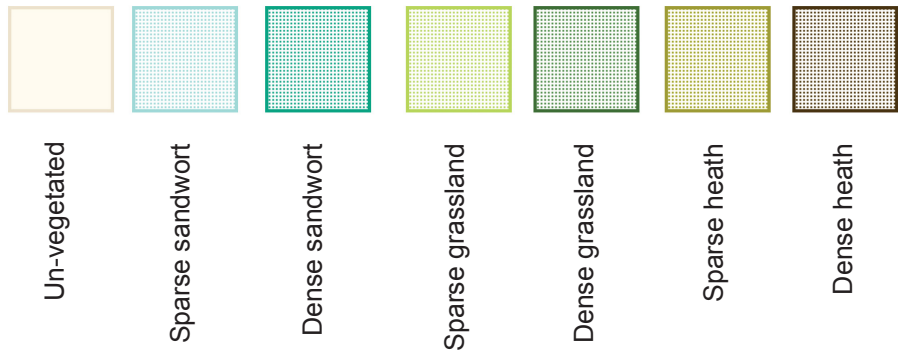

The site / vegetation plan shows the West Light shelter making use of existing sand roads, settled in the densest vegetation currently formed at Old Main Station. (Data and base map from Muise 2011)

East light is a good example of the negative impact human settlement can have on Sable Island's dynamic landscape. The position of the old East Light and Lightkeeper's House in changeable sparse grassland allowed wind to hollow a crater of un-vegetated sand as it was deflected around buildings.

The area is rich with interesting artifacts from the old settlement, including farm equipment, and evidence of past settlements' reliance on the island's horses.



11% Dense Grassland

42% Sparse Grassland

47% Un-vegetated

Land-cover (images and data from Muike 2011)



These two mounds of sand with ruins on top were the sites of the old East Light and Lightkeeper's house, around which sand was eroded to create the un-vegetated terrain, Sable Island, 2014



Images of ruins and artifacts at the old East Light settlement, Sable Island, 2014

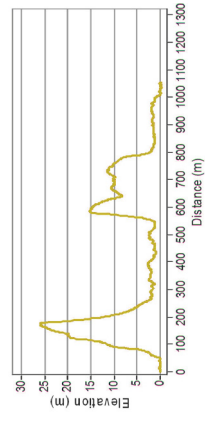
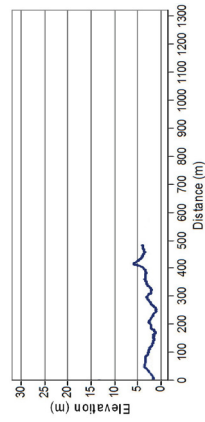
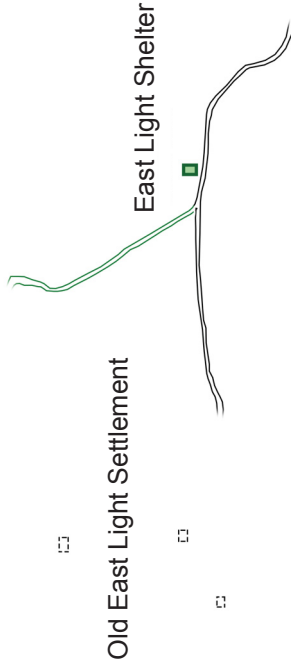
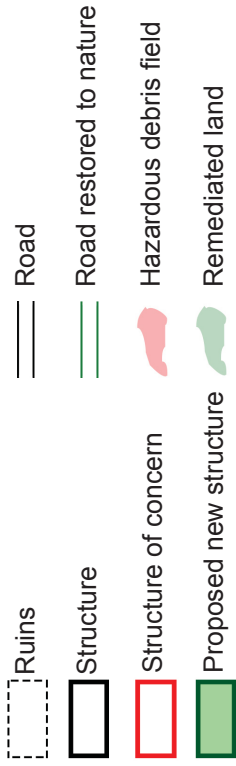

The East Light Shelter will replace the current researcher structures, overlooking the old east light archaeological site. The shelter will be a refuge for tourists, and a remote station for researchers. (Data, sections and base map from Muise 2011)

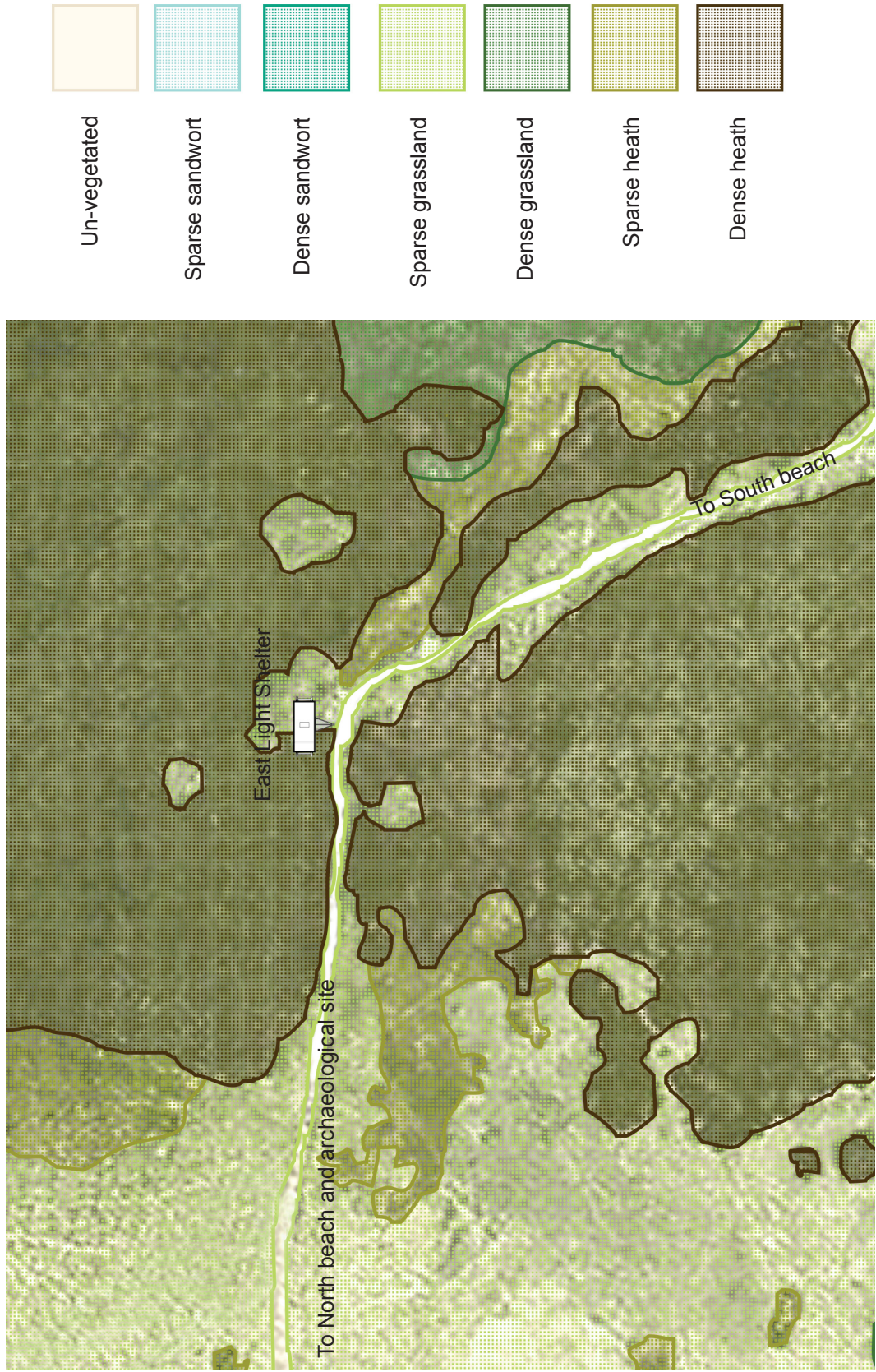

The site / vegetation plan shows the East Light shelter making use of existing sand roads, settled in dense heath at the edge of the shifting cratered terrain. (Data and base map from Muise 2011)

The shelters must have the capacity to adapt to their changing landscapes to avoid being buried or undermined. Understanding the basic principles of sediment transport is important for making design decisions.

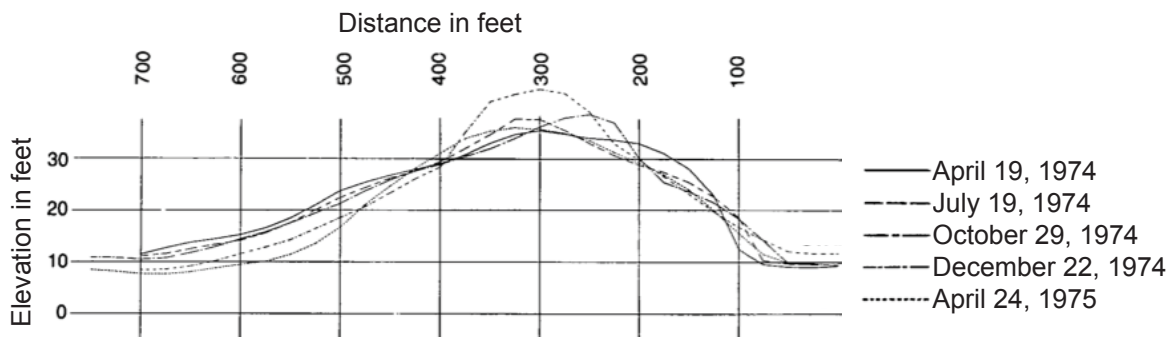

Diagram of changes observed in a section of a dune on Sable Island over 1 year (Hennigar 1976)

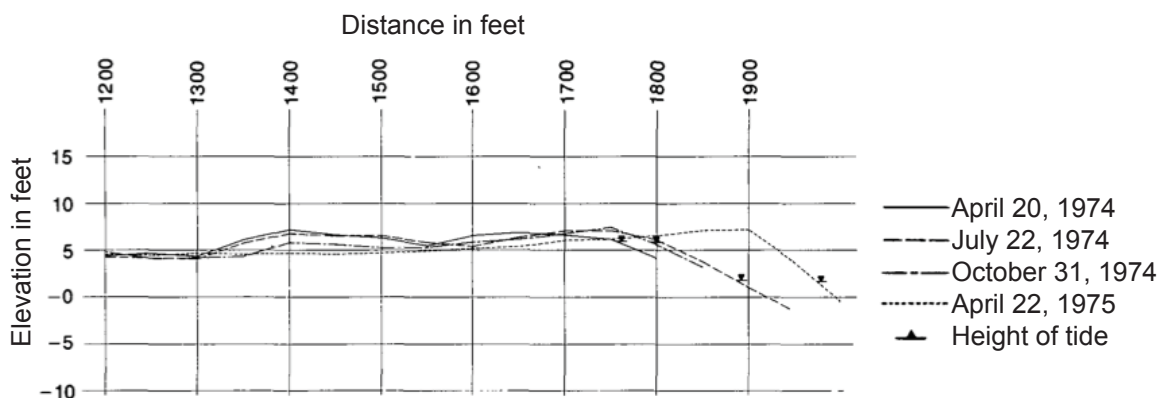
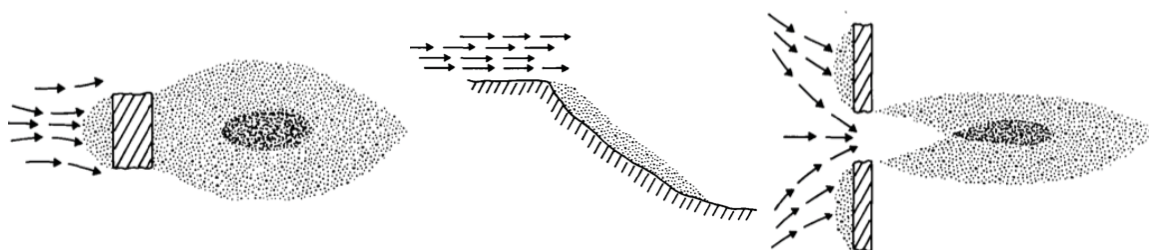
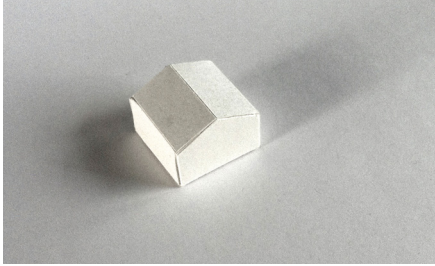

Diagram of changes observed in a section of a beach on Sable Island over 1 year (Hennigar 1976)



Illustrations depicting sediment transport around obstacles. Sand drift in lee of an obstacle (left), sand drift in lee of a cliff (middle), sand drift in lee of a gap (right), (Hennigar 1976, 20-23)

To determine how best to introduce forms to the dynamic landscape testing is conducted with models, drawings, site photographs and physical and digital wind tunnels.



Gable end house form, traditional to Sable Island. Scaled to fit National Park Program Requirements. 3-4 Levels above ground.

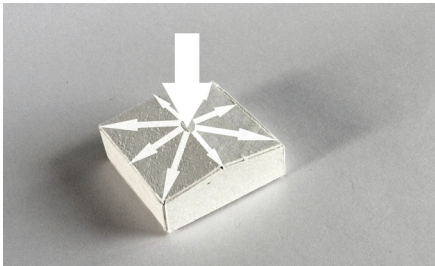

Worst wind load and weather damage occurs on tall facades, so the total height of the form is reduced.



Objects are placed in a wind tunnel to demonstrate the effects of blowing sand on structures.



The windward face of the structure accumulates sand.



This is accelerated when the structure is in the path of an advancing dune system. The generator and storage facility at West Light is being rapidly consumed by the advancing north dune.



Some structures, though out of reach of advancing dunes, are built in areas that are not stratified by dense heath root mats.

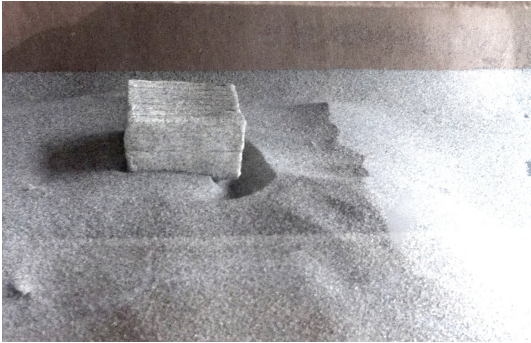

Wind that deflects off the structure erodes the loosely vegetated ground to form a bowl-like formation.



This effect threatens to undermine structures.



These two section lines highlight the bowl effect occurring around the windward faces of the house at West Light.

Learning from the root mat systems of Sable Island's vegetation can inspire a method for buildings to thrive in the dynamic landscape.



This concept employs nets at the base of pier structures (left). They stabilize the surrounding sand and encourage growth of stabilizing vegetation. The nets accumulate blowing sand (right).



Then the volume is raised above the new sand. This allows wind to pass unimpeded below (left). New nets are placed at the new sand level to encourage growth of another stabilizing vegetation mat (right).

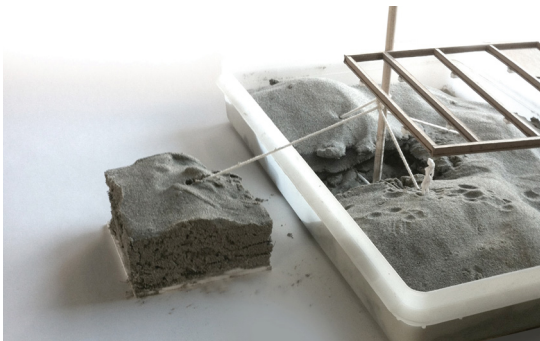

A detail model tests metal mesh root mats attached to piers by guy lines (left). A cross section shows layers of mesh in sand (right).

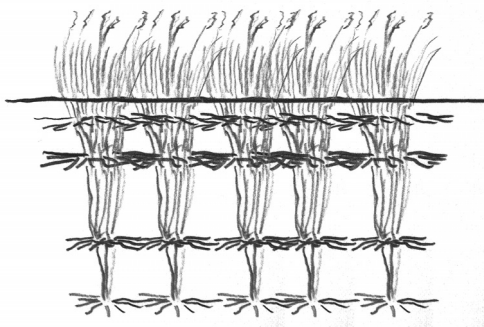

If aggregated, these theoretical structures could behave like marram grass, creating their own interlocking net / root stabilizing system (left) (Gillings 2013). Like marram grass though, major erosion around the root system eliminates its stability; causing structural collapse (right).

Learning from vegetation does not provide a complete strategy for inhabiting the dynamic ecosystem. Studying how animals connect to the landscape can inspire design of dynamic structures.

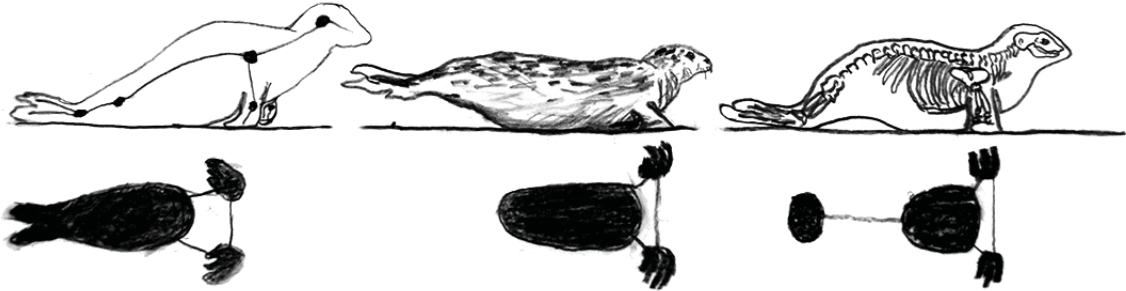

On land, seals drag their heavy load across the sand with front flipper propulsion and some propulsion from hind flippers.

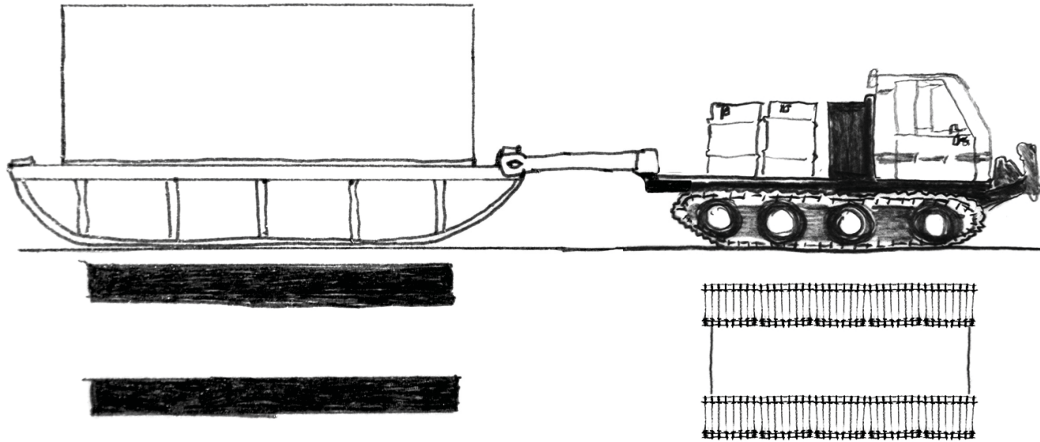

This could be done with buildings by putting them on a ski foundation and dragging them with vehicles like the Halley VI and Hut on Sleds precedents (see pages 18 and 19).

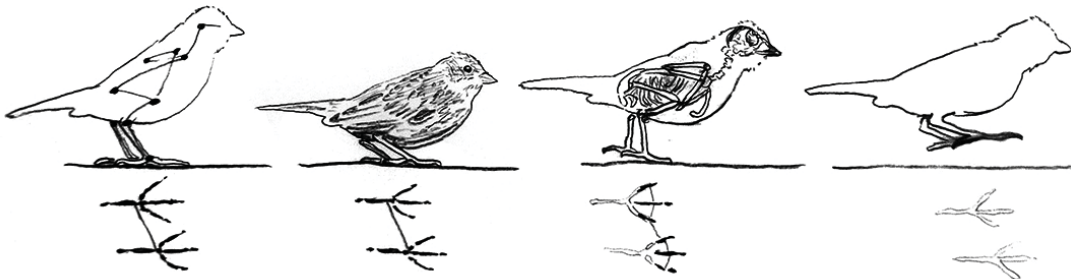

The Ipswich Sparrow uses a wide base made of lightweight members to stabilize during dynamic motion.



This inspired a ski with a widened base and thin truss system.

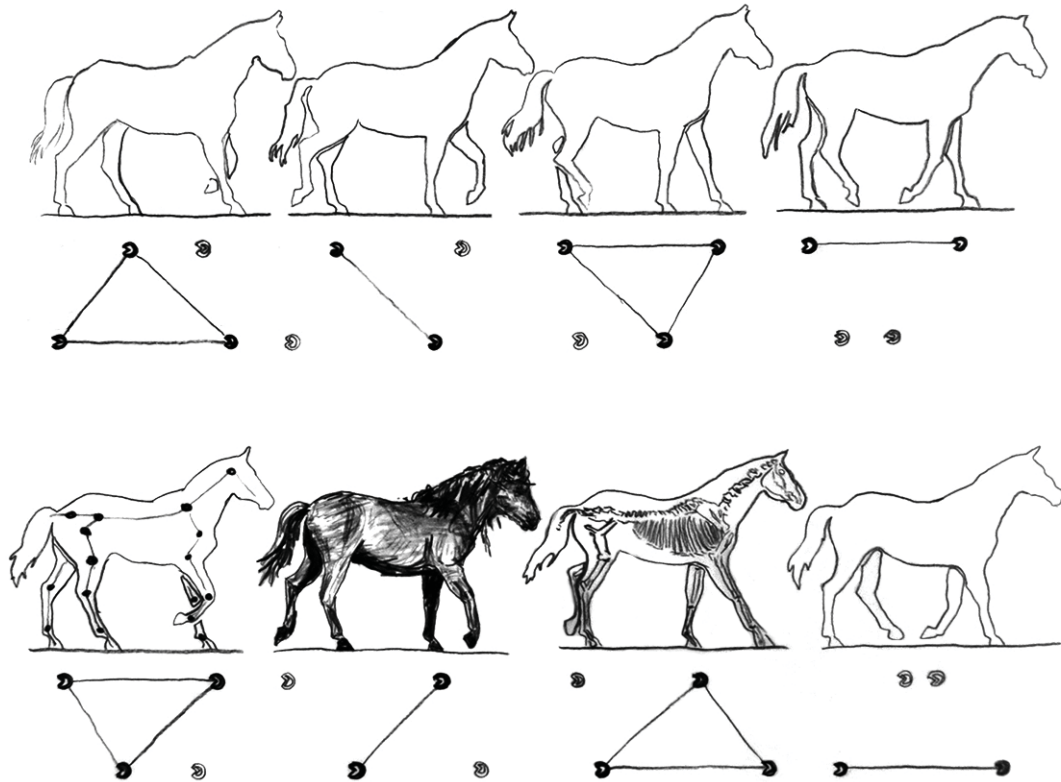

The wild horses of Sable Island shift their loads between two and three legs cyclically to propel them forward; a redundancy of load paths is used for dynamic motion. (Diagram redrawn from Zimmer 2009)



At any point during motion a ski could be partly off the ground, and the load would need to rely on another path, so extra truss segments were added.



The load on the skis needs to be leveled when not in motion. A screw-jack, hand operated like a capstan on a ship, is integrated into the truss components.

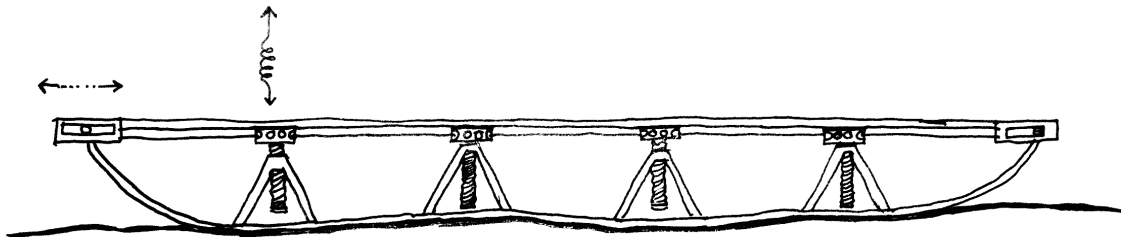

The bottom component of the ski can be made flexible to conform to the sandy terrain when leveling.



Identical mobile structures are proposed for Old Main Station and East Light to commemorate the two lighthouses which kept watch over the island. This illustration depicts researchers working from the West Light shelter during winter.

The compact shelters include small insulated spaces for sleeping facilities and a composting toilet. They have protected outdoor spaces that can act as a bird hide, with sliding doors at every opening to tune visibility and protect from weather.

Rain water is collected to give hikers a fresh drink, and to be used as ballast to weigh down the light structure when it is not being moved. When savage storms change the island enough to compromise the position of the shelter park staff can prepare it to be moved.

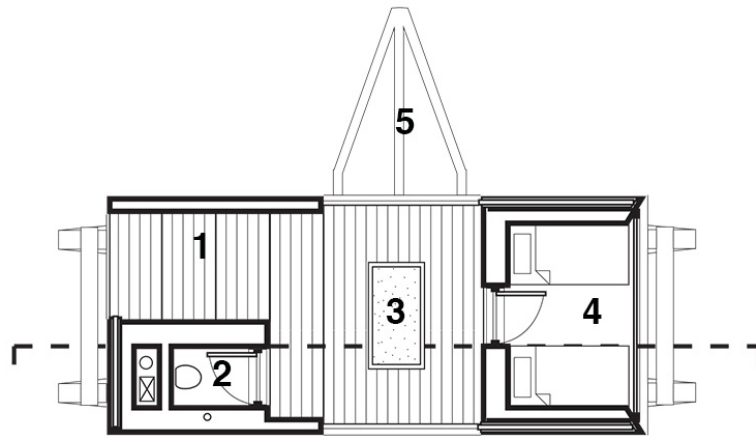

The plan of the shelter shows the stepped seating area with storage below (1), the composting toilet (2), the fire pit (3), the bunk room (4), and the entry ramp which can be attached to the ends and used as a trailer hitch for towing (5).

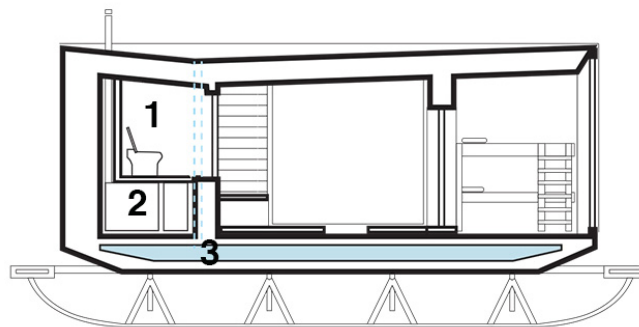

The section shows how the shelter's systems are organized. The composting toilet is one and a half metres above the main level (1). Compost and compost tea are stored underneath the toilet, and accessed for emptying from the outside of the shelter (2). The sloping roof collects rain water that is stored under the floor; a tap outside draws water from the ballast for drinking and cleaning (3).

Moving heavy loads in sandy soil is difficult, but the island's natural forces can be harnessed to aid in movement. Applying nautical technologies to land based machines was successful for years. The chinese wind-sail assisted wheelbarrow inspired Simon Stevin to design sailing carriages in the 1600s. Sable Island, with its strong winds, is an excellent place to reuse this old technology, reducing reliance on fossil fuels.

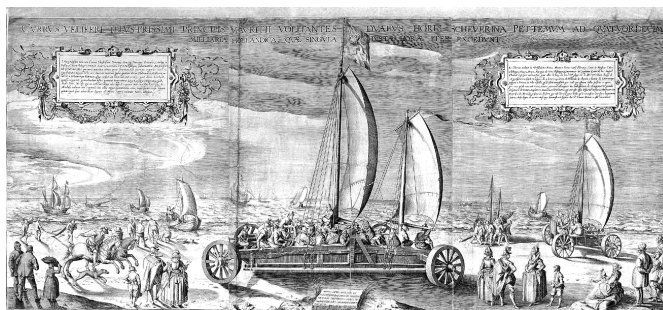
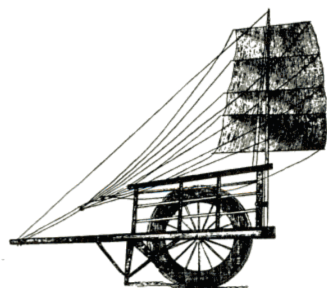

The Chinese wind-sail assisted wheelbarrow (left), and Simon Stevin's sailing carriage (right). (Needham 1965, 275-281)

The East and West Light Shelters are easily relocated. The units can be pulled by just vehicles, by vehicles assisted by wind, or even just by wind if conditions are favourable.

Employing kite technology ensures maximum exploitation and control of wind resources due to its ability to maneuver through the wind-window. (Kiteboarding Evolution 2014)

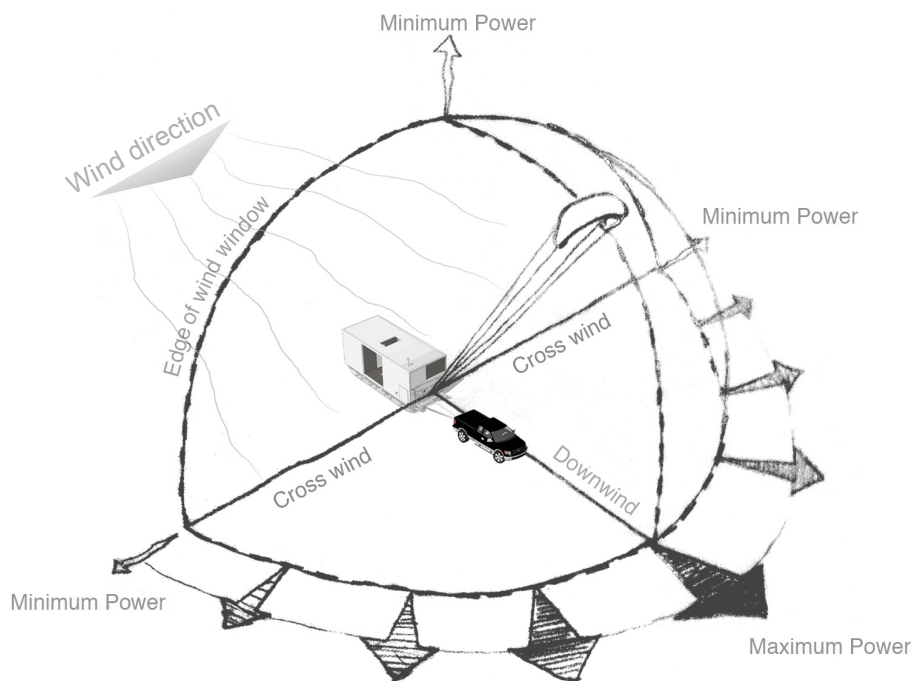

A kite, stored under the seating area, assists with towing the shelter.

Kite technology can also be used to power the mobile unit. As the kite reels out an attached, airborne, autopilot unit maneuvers it in crazy eight cycles upward. After reaching a determined height, the kite is recoiled onto a generator turbine reel. More energy is produced by the wind while reeling out than is required to reel in, so the process generates electricity which is stored in a battery bank. (Fechner and Schmehl 2012)

The electrical load of the shelter is very low, so a few hours of kite power generation per week is sufficient for continuous operation. When not in use, the kite system is reeled in and stored under the seating.

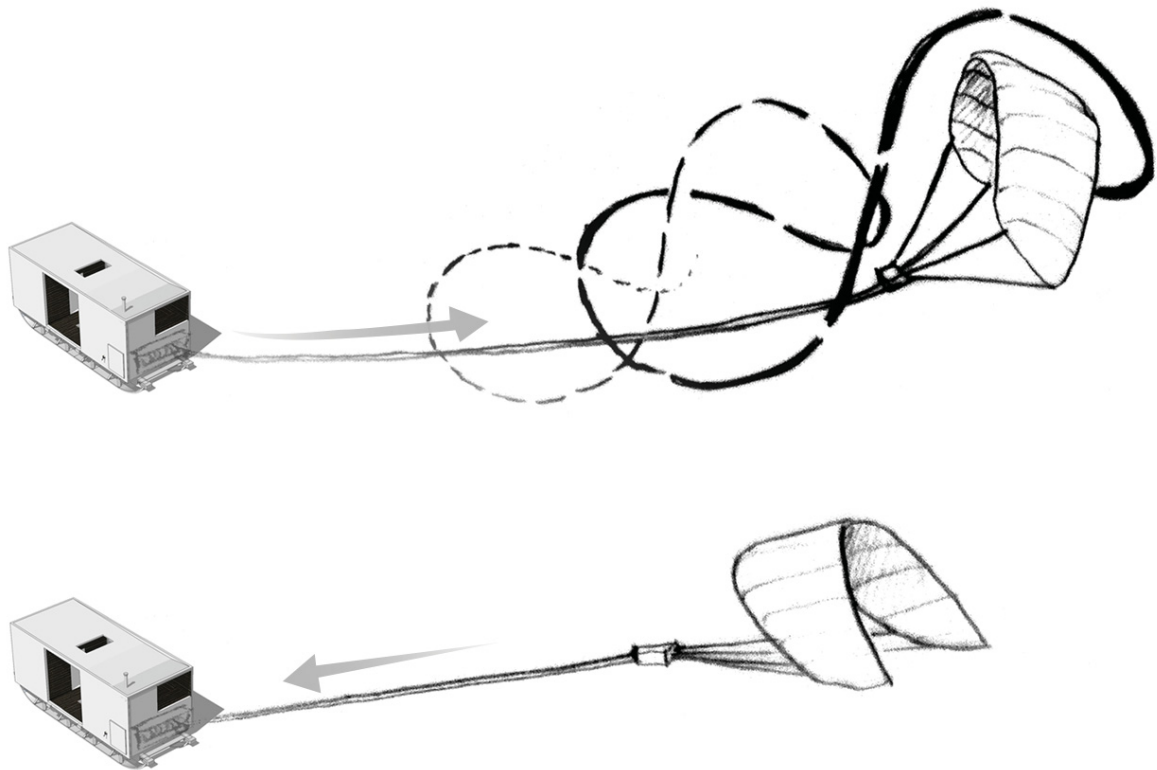

Diagram demonstrating the reel out and reel in process for power generation. (Redrawn and applied to the shelter from Fechner and Schmehl 2012)

The mobile shelters follow their changing habitat and provide the essentials for living anywhere on Sable Island. They can be relocated short distances to adapt to their site, or long distances to support site specific research, or even to serve as construction trailers for builders assembling the other structures on the island. The East and West Light shelters continue the dynamic tradition of relocation started by the many incarnations of the East and West Lighthouses.



On moving day the shelters can hit the beach to relocate to safer ground. The small island population can easily perform the task with one person to control the kite, one to drive the truck and one to drive ahead to make sure there is a clear path.



Photographs of the West Light (top) and East Light (bottom) Shelter Models.

Visitor / Research Centre

The centre of the island is more stable, where the Visitor / Research Centre is located. It is ideally situated as the first point of contact on the island directly between the main landing strip on the south beach and the primary anchor point on the north beach. Within hiking distance of the interesting A-Frame ruin (see page 11) and Bald Dune, the Visitor / Research Centre is a perfect hub for tour groups.

The narrow trough of tall dunes provides excellent shelter, but when breached becomes very exposed. In the unlikely event that a dune breach undermines the Visitor / Research Centre, it will need to be moved to safety, and can be resettled anywhere along the trough.

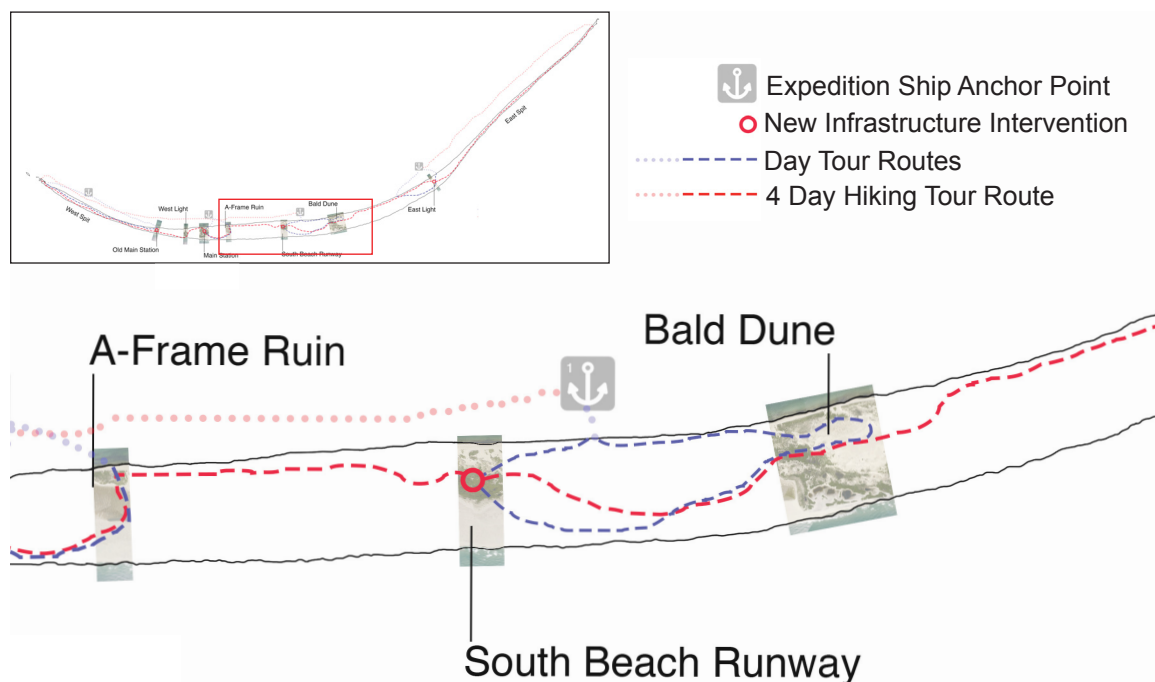







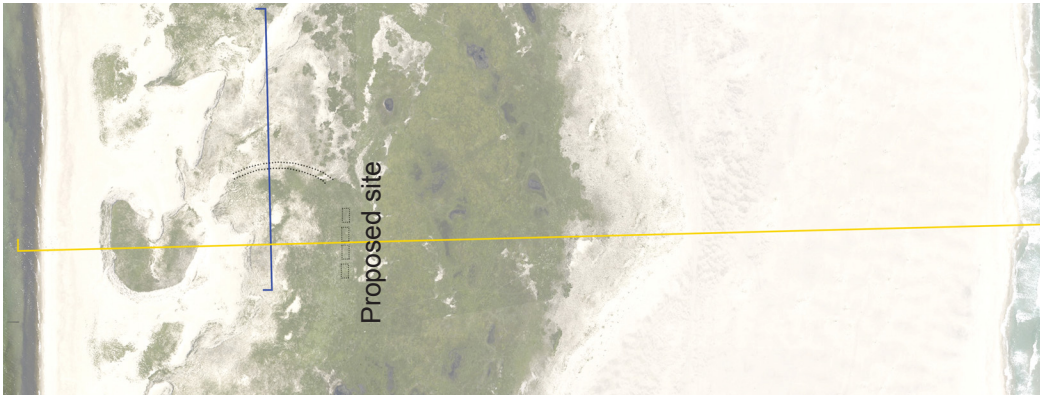

Enlarged island plan showing the Visitor / Research Centre. Data for maps from Muise 2011.



Panorama of the narrow trough overlooking the South beach.



-  Ruins
-  Structure
-  Structure of concern
-  Proposed new structure
-  Road
-  Road restored to nature
-  Hazardous debris field
-  Remediated land

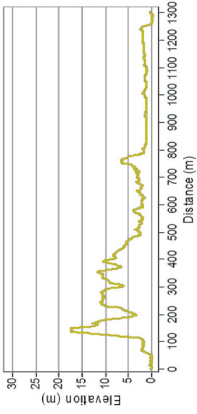
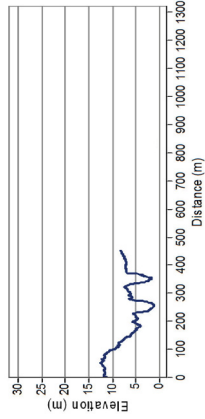

- 5% Dense Grassland
- 25% Sparse Grassland
- 17% Dense Heath
- 2% Sparse Heath
- 51% Un-vegetated

The Visitor / Research Centre is located in a currently undeveloped area. A road to the North beach is proposed, following a naturally un-vegetated path through the dune. The south beach can be accessed by following horse paths through the heath. (Data, sections and base map from Muise 2009)

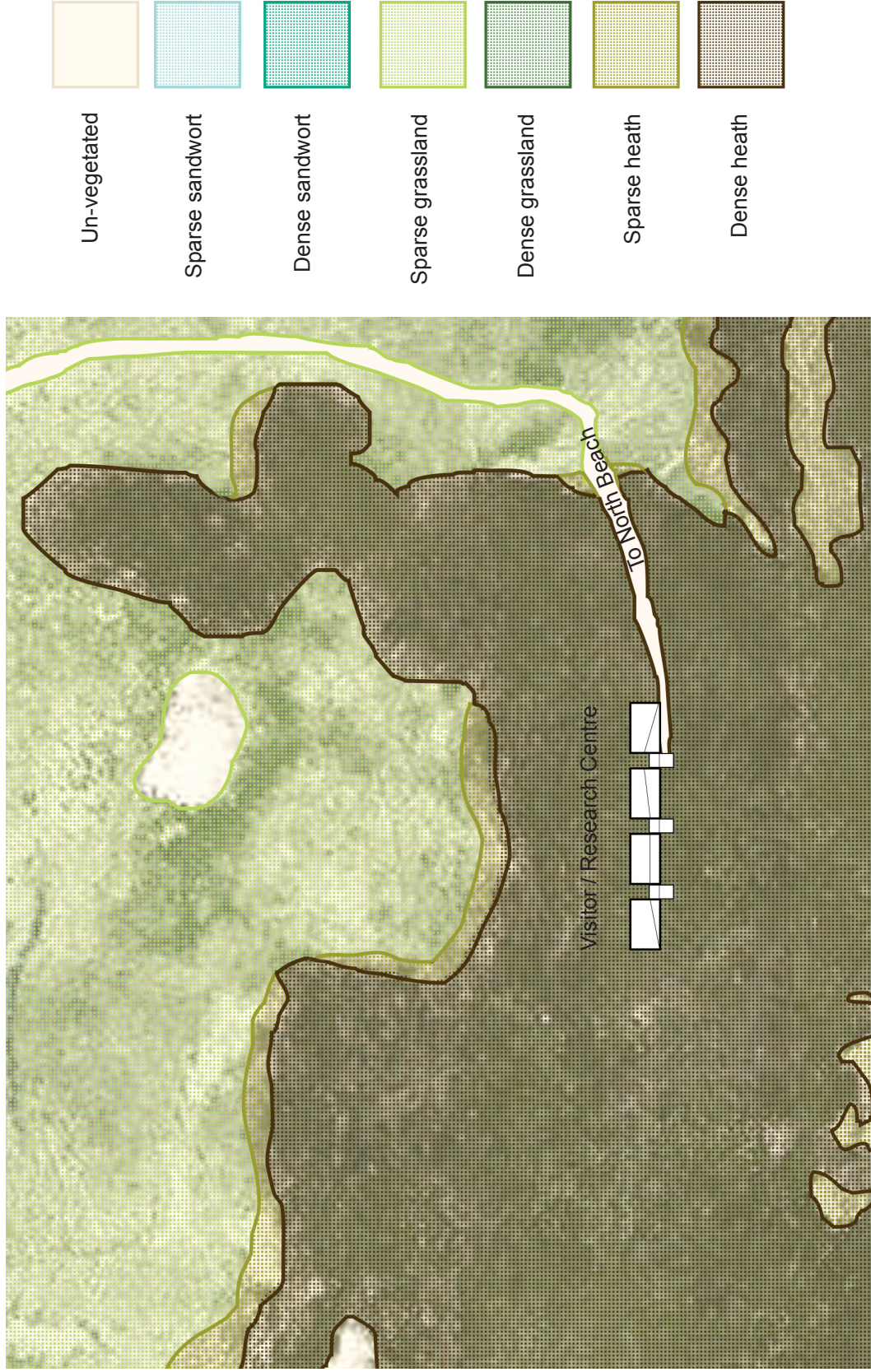

The site / vegetation plan shows the stable heath environment the Visitor / Research Centre occupies. (Data and base map from Muise 2011)

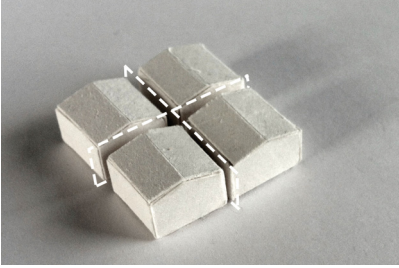

If a dune breach undermines the Visitor / Research Centre it will need to be relocated. The design is therefore divided into small, lightweight, modules to allow for ease of movement.



Groups of volumes are tested in the wind tunnel. Windward facades, and narrow gaps between them, accumulate sand. Forms in lee of other forms accumulate sand more slowly than their windward protectors.

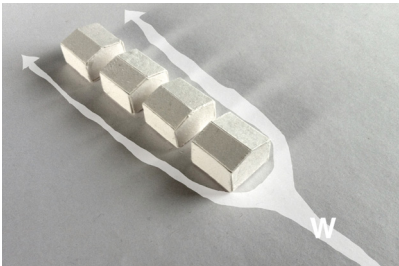

Arranging the forms in a row toward the prevailing wind maximizes protective lee areas.



A rearranged group is tested in the wind tunnel (left). Much less sand is accumulated in this formation (right).

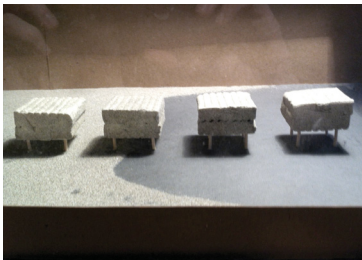

Raising the forms on stilts eliminates sand accumulation, as is demonstrated by the unchanged terrain at the base of West Light.



To develop aerodynamic forms, sand is eroded in the wind tunnel. First the form is undermined, caused by wind accelerating where it is deflected off the ground (middle). Next, the form begins to slope downward to the wind direction (right).

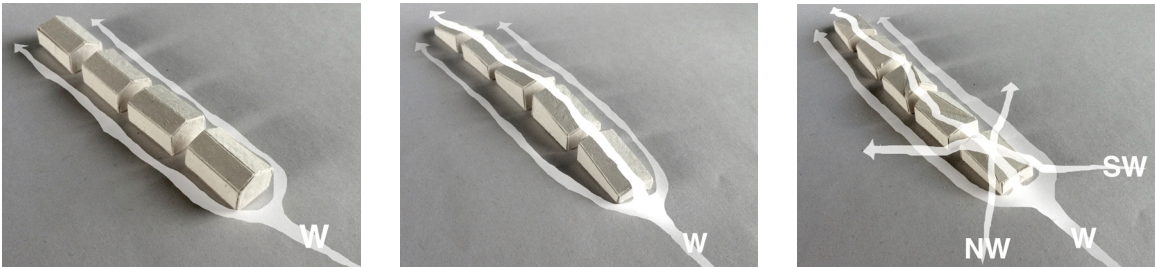

Thinner and longer forms further reduce prevailing wind load (left). Sloping roof planes produce aerodynamic forms (middle). NW and SW storm winds, and prevailing west wind, sculpt roof forms. Gable facades in protected lee zones reference traditional Sable Island house forms, in an aerodynamic whole (right).

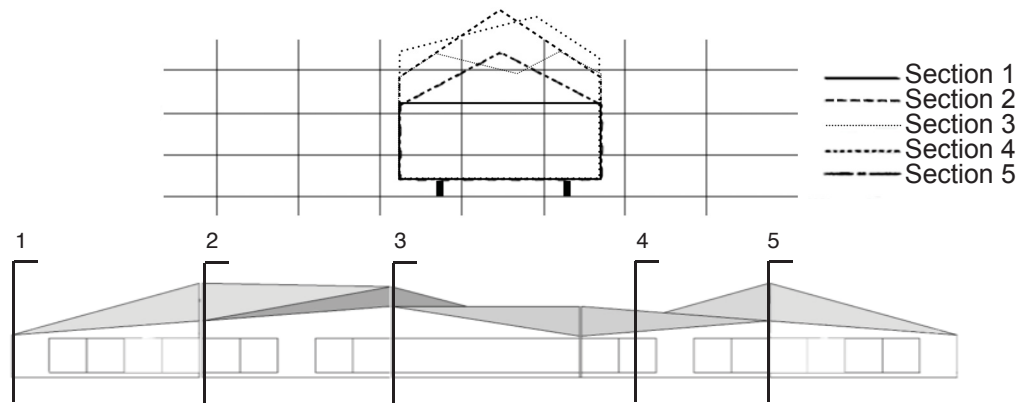

Forms become reminiscent of the changing dunes around them, as the roof-scape shifts between traditional gable ends.

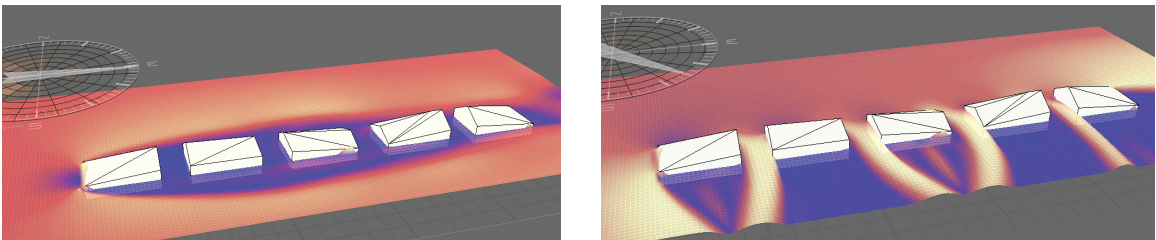

The “dune” of structures creates microclimates between the forms, protected from the prevailing west wind. The previously protected zones face extreme winds during storm winds from NW and SW. Storm doors can be closed during these conditions.



The Visitor / Research Centre becomes a modular, habitable, dune raised above the rolling heath. It is made of four modules: Two cabins, and a field office / visitor reception area, and washrooms / solar showers.

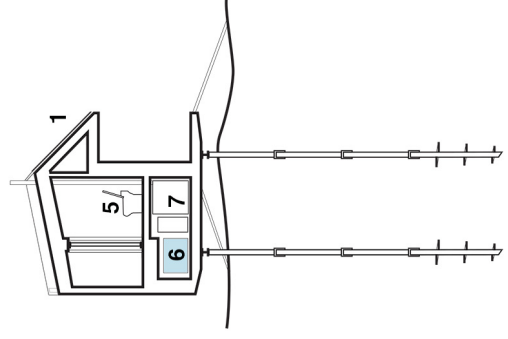
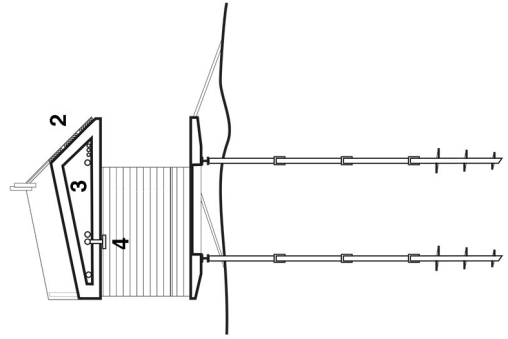
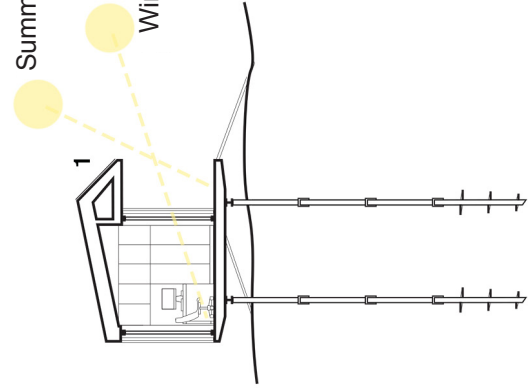
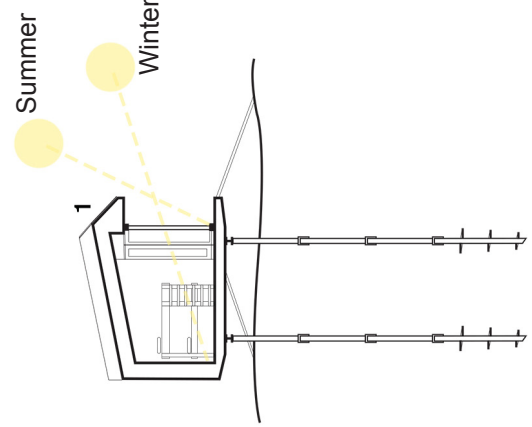
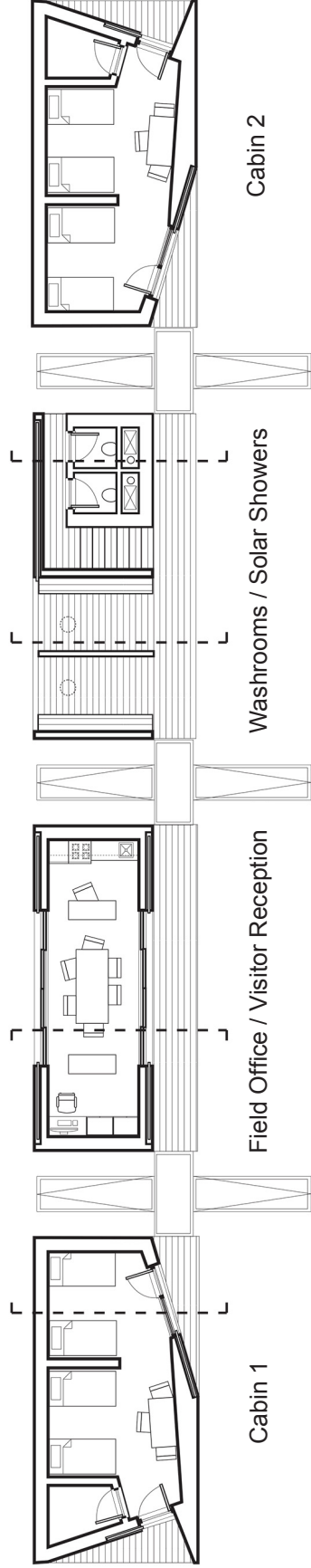

The centre is used mostly between spring and fall, so the sloping roof planes are optimized at a 45 degree angle to collect solar energy. Photovoltaic panel awnings collect solar energy in battery banks behind (1). The interior spaces are shaded by the awnings in the summer, and heated passively by the winter sun. Solar Thermal panels on the washroom unit heat rain water (2). Plumbing runs through the roof (3). Outdoor showers use the heated rain water (4). Composting Toilets (5) are raised one and a half metres to allow room for water storage (6) and compost and compost tea (7).



The microclimates created by the Visitor / Researcher Centre allow for reduction of climate controlled interior spaces as the sheltered exterior spaces are made comfortable.

Solid and liquid waste is converted to rich compost and compost-tea fertilizer. Composting toilets are waterless, and use very little energy to run a small fan in the exhaust chimney that ensures air pressure pulls air and odours outside through the toilet. The products can be emptied from outside to avoid mess inside.

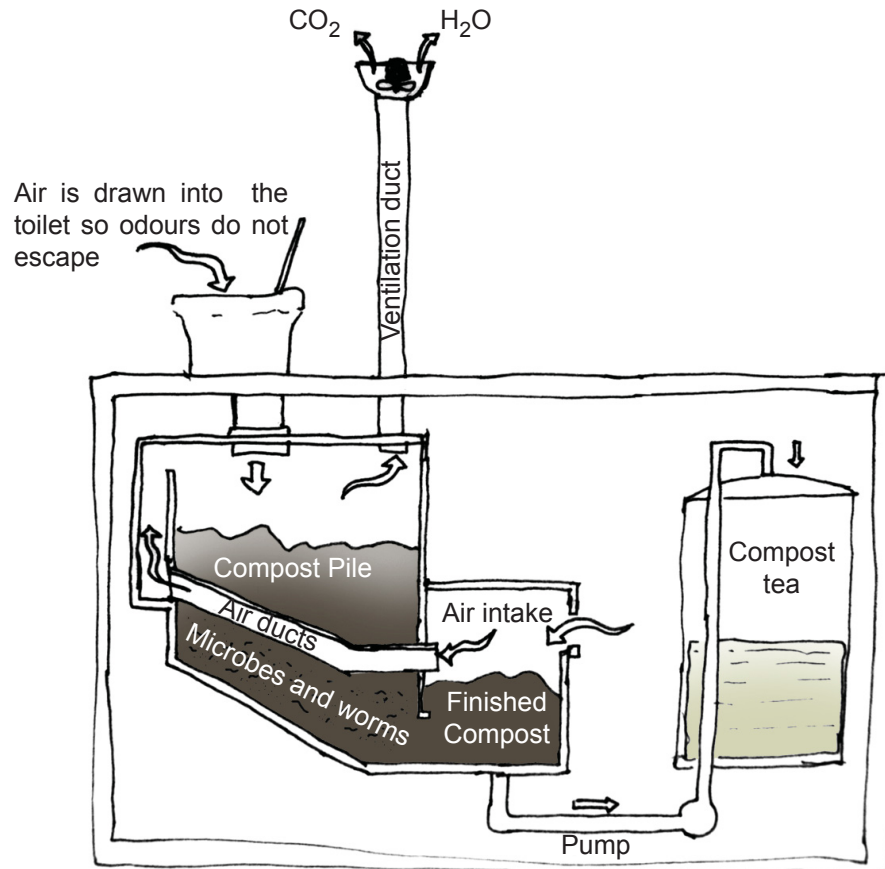

This sketch was made on a site visit to the composting toilets at Peggy's Cove, Nova Scotia.



Some areas of the island are damaged by human activity, removing stabilizing vegetation.



Compost and compost tea can be used to encourage re-growth of stable heath in these areas.

The historic Lifesaving Station had similar boat house structures built on piles across the island. Lifeboats were launched from them and pulled to the beach by horses to rescue shipwrecked sailors.



Lifeboat crew drill at boat house (left). (Campbell 1994) Life boat being taken to the beach (right). (Garside 2009)

Modular helical piles form the Visitor / Research Centre's foundation. If sand drifts around the modules they can be jacked up to so new sections of piles can be added; the modules can "grow" through accumulating sand.

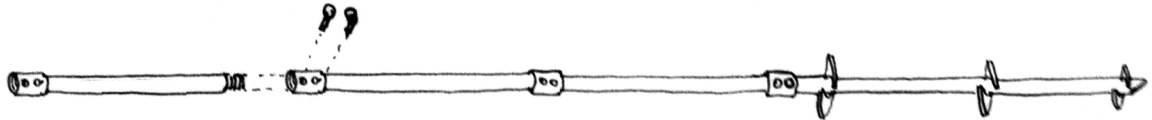

The first length acts as a screw for driving the pile. As the pile is driven into the earth new lengths are bolted on until the desired depth below, and height above, ground is reached. (Sketch drawn based on data from Helical Piles of New York 2014)

If the Visitor / Research Centre is undermined by a dune wash out or major landscape change it can be resettled using small machines and simple technologies. Newfoundlanders resettled their homes with man power and simple machines after confederation in 1949. (Art Gallery of Ontario 2011)



David Blackwood's representation of Newfoundlanders moving a house with an anchored block and tackle. (Art Gallery of Ontario 2011)

The first step in resettling the Visitor / Research Centre is to dispatch a ski trailer with all necessary equipment from Main Station.

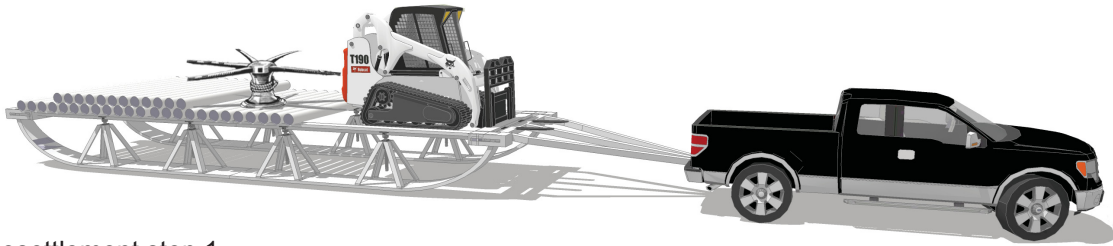

Resettlement step 1

Helical piles are driven at the chosen resettlement site. The first foundation is assembled and a capstan anchored with a helical pile is fixed at the end.



Resettlement step 2

The ski trailer is taken to the Centre, and the first module is loaded onto the ski trailer. The module can then be towed by wind and vehicles like the East and West Light Shelters if the new site is far away, or can be attached to the capstan for towing over short distances.

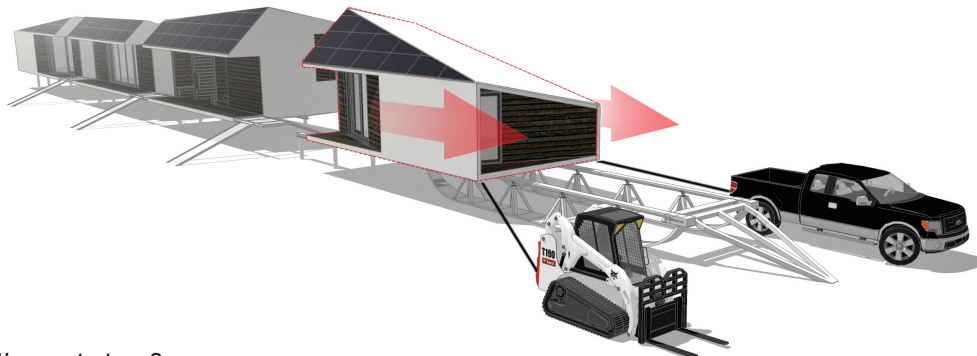

Resettlement step 3

Once the module is in range of the capstan and block and tackle, it can be reeled in with the capstan. Unused lengths of helical piles can be laid out to drag the module over uneven terrain, reducing impact on the surrounding landscape and easing the reel in process..

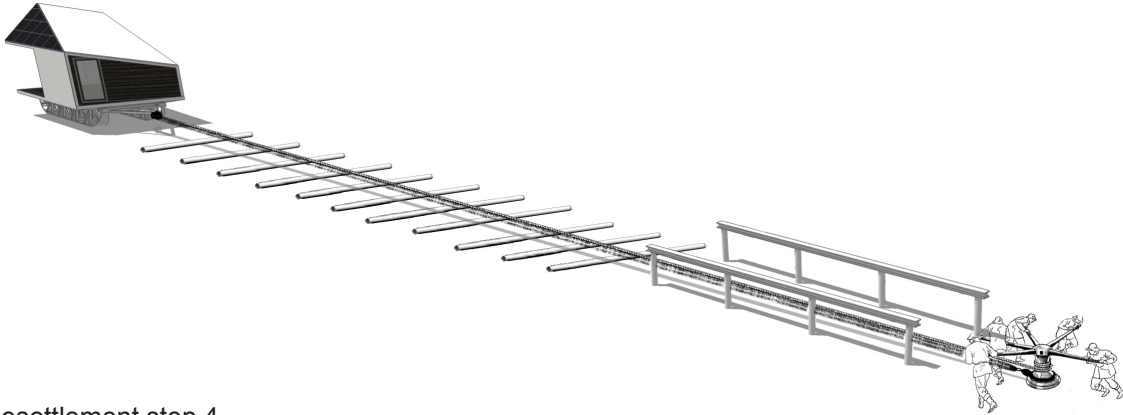

Resettlement step 4

Finally the module can be disconnected from the ski trailer, and pulled onto the new foundation. The same process can be repeated to resettle the remaining three modules.

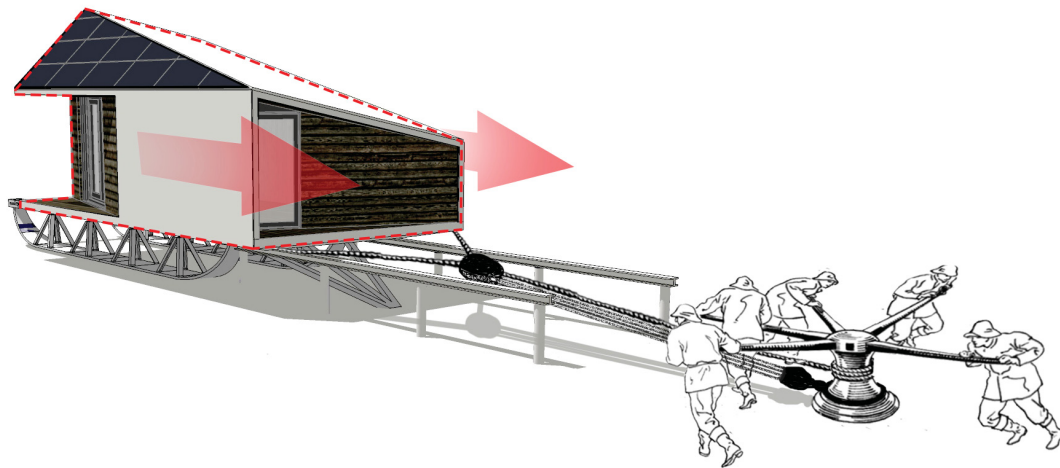

Resettlement step 5

This resettlement process would only be necessary in the unlikely event of a major dune breach. The Visitor / Research Centre, once completed, could be used as a temporary Main Station for park staff while work crews populate the Main Station site during remediation and construction.

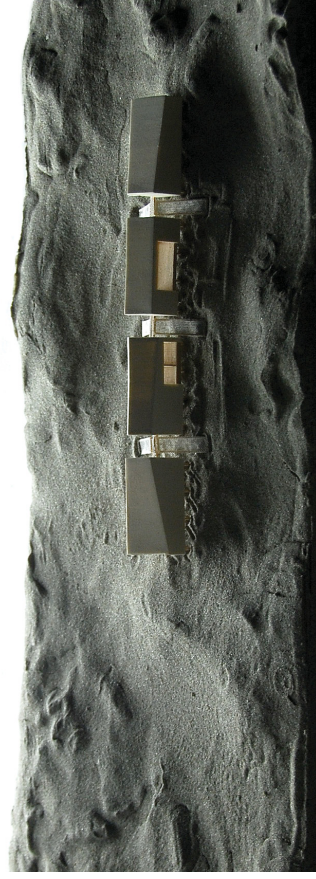
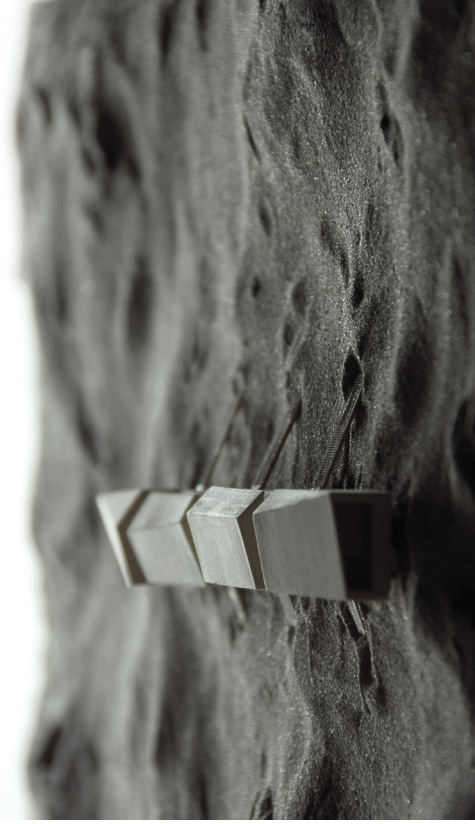

Photographs of the Visitor / Research Centre Model. The open south facade (top), the wind-sculpted roof scape (bottom left), and the protected north facade (bottom right).

Main Station

The current Main Station is located in the widest, most stable, heath habitat on the island. It is settled in a natural bowl, lower than surrounding terrain, and is well sheltered from wind. Main Station currently relies on fossil fuels for power, heating, and running vehicles. The new design will replace existing infrastructure to reduce heated space, energy demand and reliance on fossil fuels. The north dune is shifting slightly, threatening to engulf some existing structures, so the new build will occur further inland.

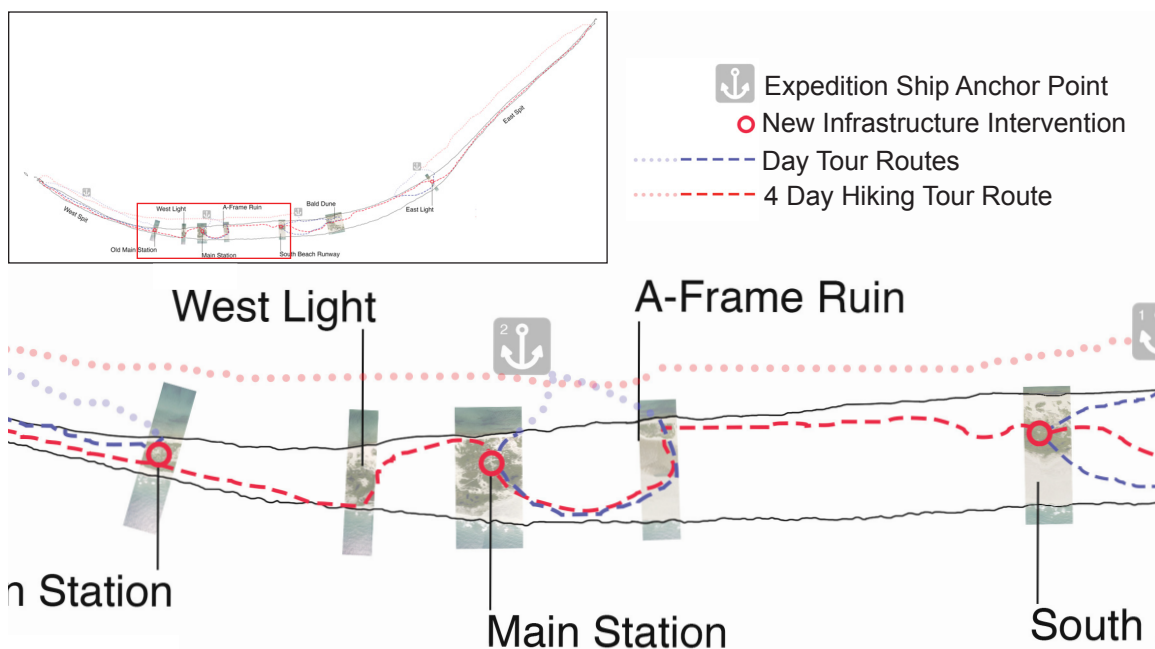

Enlarged island plan showing the Main Station. Data for maps from Muise 2011.

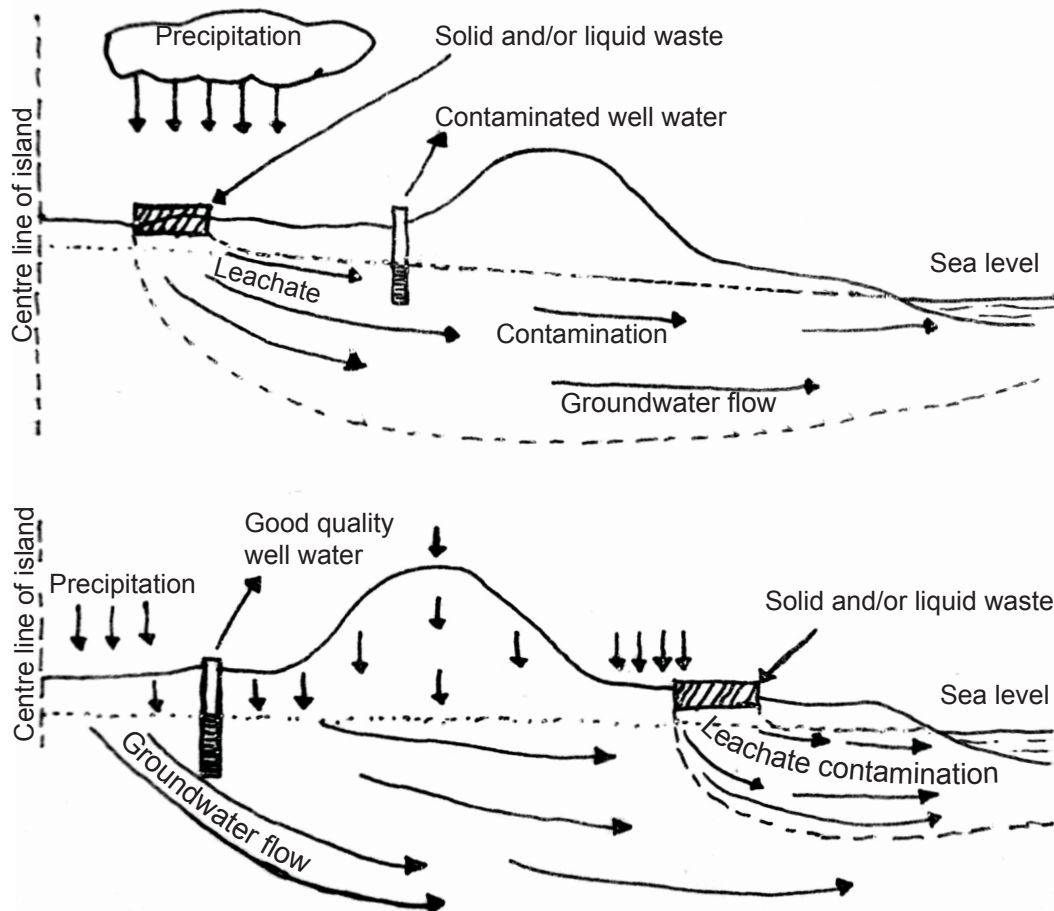

Photo of Main Station from helicopter.

Fuel is currently stored in an over-sized tank farm which is now surrounded by the north dune, posing an environmental risk in the fragile dune habitat. The tank farm will be removed and fuel will be stored in drums in small quantities to reduce spill risk. A new septic field can be installed where the tank farm once stood. Its position in the dune will allow contaminations to exit the lens via ground water flow, and the fertilizing properties of sewage will encourage vegetation growth in the fragile footprint left by the tank farm.



The tank farm.



Groundwater flow and septic relationship diagrams redrawn from Hennigar 1976.

The station currently relies on the island's aquifer lens for fresh water. Maintaining a low-population allows the new design to continue this practice without damaging the lens. Relying on the island's own water storage and ground water systems will deepen occupant's relationship with their ecosystem, appropriately demanding use of only environmentally friendly products.

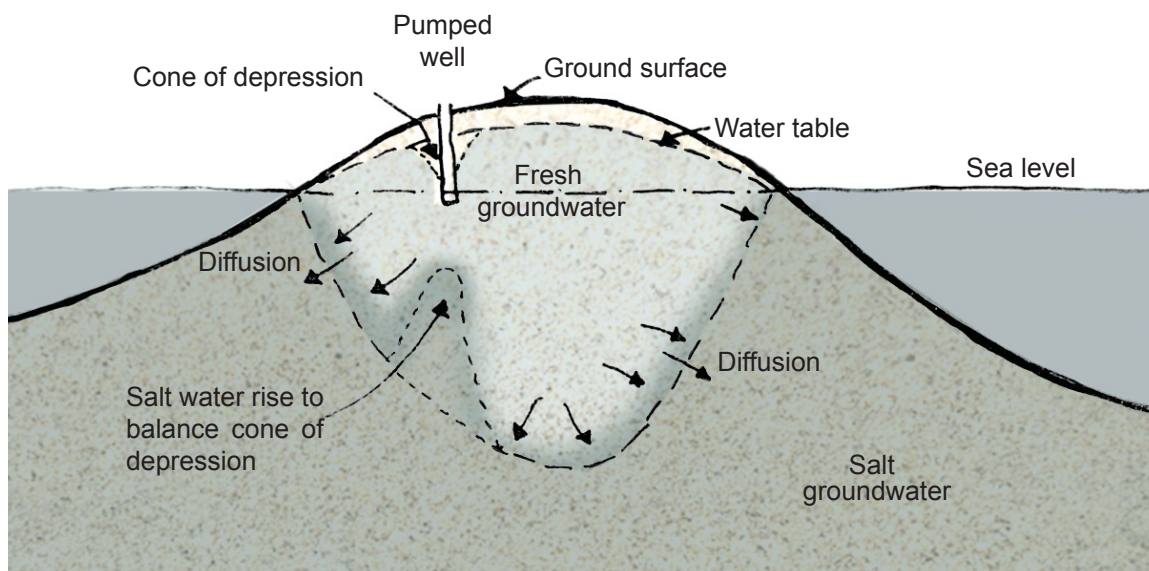

Fresh water lens and well relationship diagram redrawn from Hennigar 1976.

This largest and most stable heath environment on the island is a coveted habitat. The station is currently fenced in to keep the wild horses from scratching against the buildings, but the determined horses frequently destroy the fences to find the bounty of food, water, and man made scratching posts beyond. It is also a popular nesting place for migrating birds.



Images and data from Muise 2011

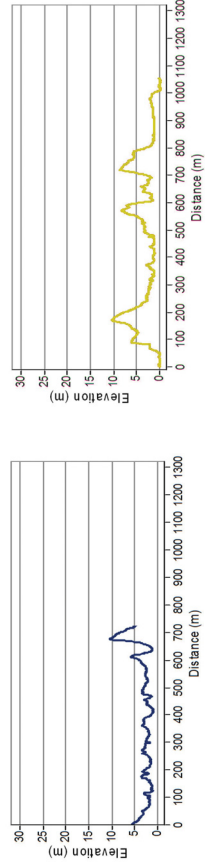
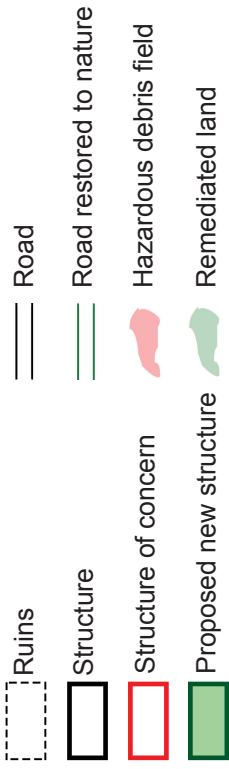
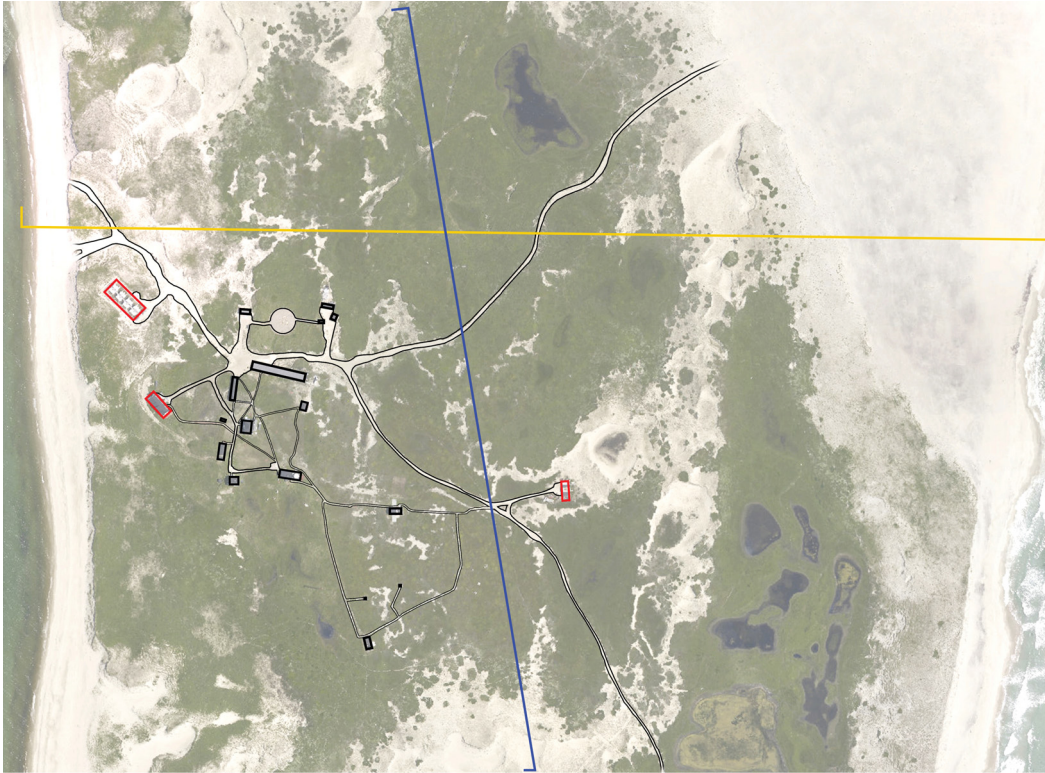

Main Station is the largest existing settlement on Sable Island, requiring the most remediation. Over sized fuel tanks, dilapidated houses, an incinerator shed and debris will be removed, and most roads and paths will be restored to nature. The helpad, air chemistry field and main roads to the north and south beaches will be retained. (Data, sections and base map from Muise 2011)

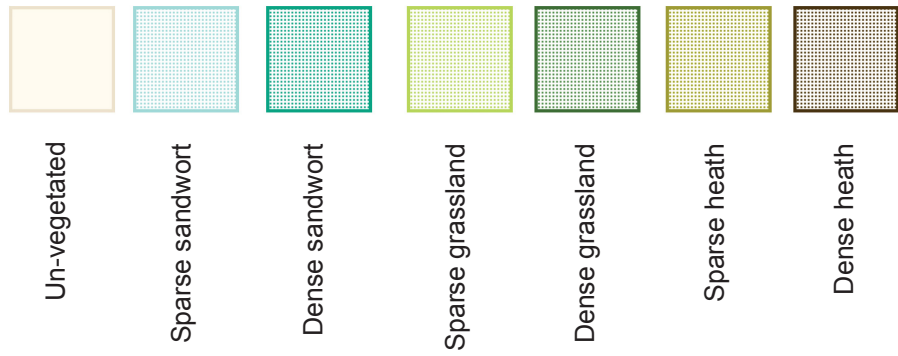

The site / vegetation plan shows the Main Station making use of existing sand roads to connect to the north and south beaches. Areas where buildings have been removed will start to revegetate with sparse grassland, but soon will grow into established heath. (Data and base map from Muise 2011)

Weather, fuel storage, garage and maintenance facilities are required on ground level with concrete containment floors to prevent spills. These facilities will be too heavy to move, so a strategy is necessary to allow the Main Station to remain static in the fluid landscape.



These massive facilities can be placed to capture blowing sand, making an artificial dune (left and middle). The artificial dune can be made with interlocking retaining wall blocks, which serve as planters. Grass will grow in the planters, catching sand, and encouraging dune formation (right) (Grotto Hardscapes 2014).



1:10 and 1:20 test models were put in place at main station, to test sand accumulation (left). A few weeks later a snow storm demonstrates how the models will accumulate blown sand. The locals seem to approve, as the seals have already moved in (right).

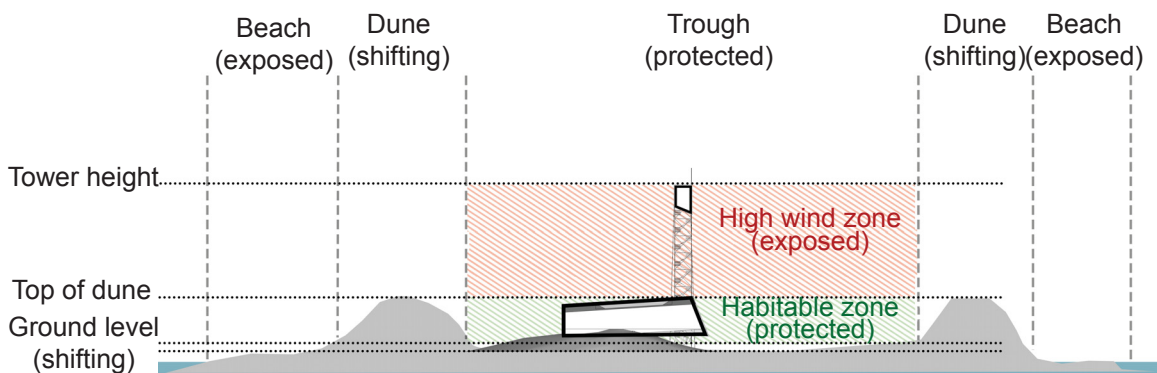

The program also requires a one hundred foot tall, freestanding, tower for mounting a radio antenna and weather monitoring equipment. Wind is much stronger at heights above the dune line. A habitable space can be raised above the shifting landscape, but below the dune line, anchored by an artificial dune structure and intersected by a tower.

Main Station is home to full time staff working on Sable Island for several months at a time. Design of permanent staff residences should encourage social interaction to lighten the challenges of isolation. A courtyard is an excellent social plan, providing views between work, circulation, and recreational spaces.

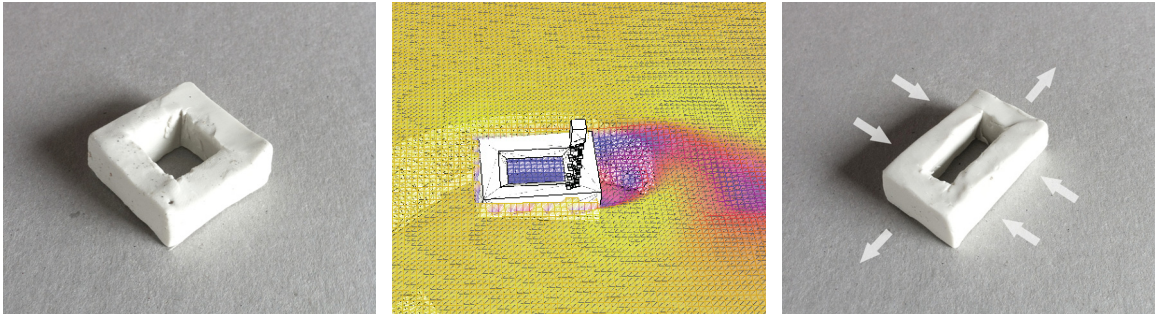

The courtyard form creates a microclimate, protected from all wind directions (middle). It can also be adjusted to be more aerodynamic (right).

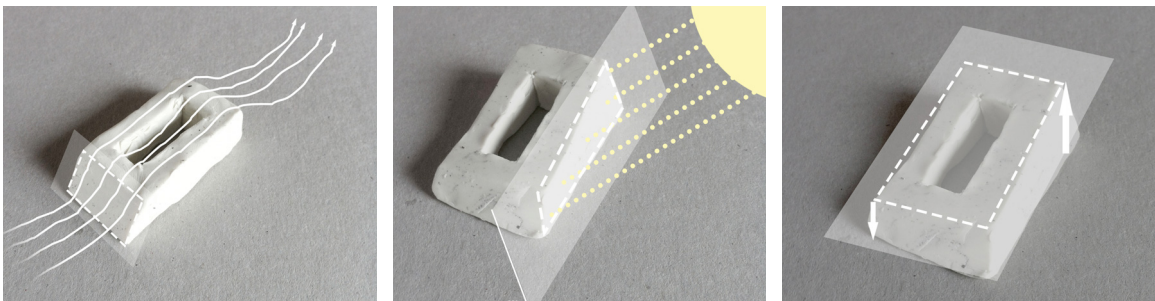

Sloping the west wall to the prevailing wind decreases wind load (left). Cutting the south facade at 22 degrees from the vertical is optimal for collecting solar energy (middle). Sloping the roof further increases solar collection capacity, and decreases wind load (right).



Wind is most turbulent at corners, so proactively eroding them with entrance and balcony openings reduces stress on connections (left). An “eroded” facade around openings and edges breaks wind speeds, and protects the building (middle and right).

To avoid sand accumulating on the artificial dune and engulfing the whole station, a narrow gap between the courtyard and artificial dune is created. The Venturi Effect accelerates wind flowing through the gap, clearing the sand. “The Venturi-effect refers to the increase in fluid speed due to a decrease of the flow section in confined flows.” (Blocken, Moonen, Stathopoulos, and Carmeliet 2008, 1)

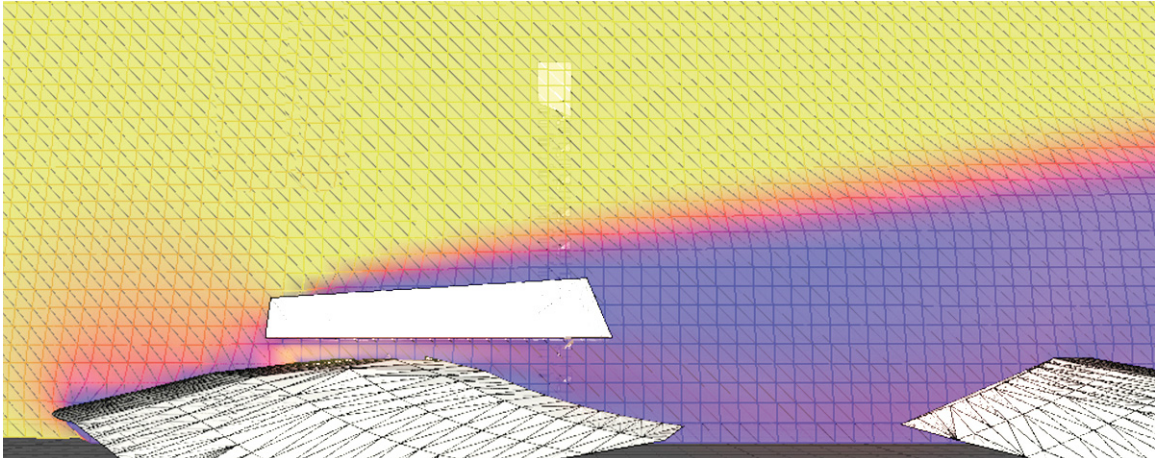

Sand accumulates until it reaches this narrow gap, where the Venturi Effect accelerates wind to clear sand.

During northwest storm winds, sand is blown through the gap and accumulates in lee of the artificial dune. Southwest storm winds deflect off the garage facade and erodes accumulated sand. The two effects balance each other, reducing need for machine driven sand clearance.

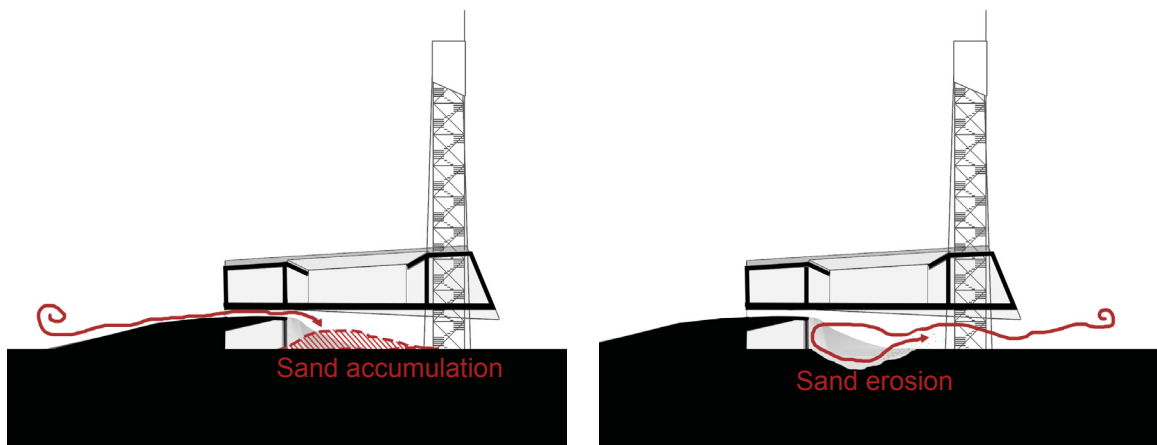

Sand accumulates under the courtyard during winter (left), and is cleared during summer storms (right).

Settled in the centre of the widest, most stable, heath habitat Main Station is safe from dune breeches and washouts. In its privileged position it can remain strategically static to house the unique program. Balancing wind patterns, effects and sediment transport principles the building engages with the island's dynamic processes to create a balanced microclimate.

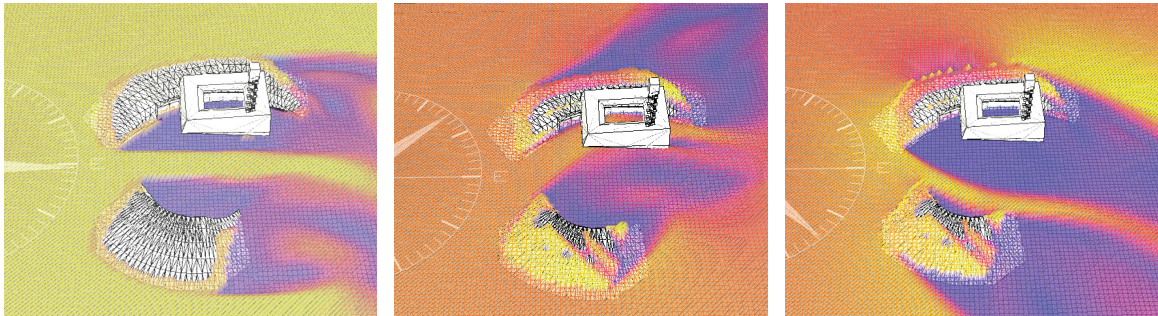

The station is completely protected from the prevailing west wind (left). Summer storm winds clear the main path (middle), and winter storm winds clear the path to the hydrogen shed (right).

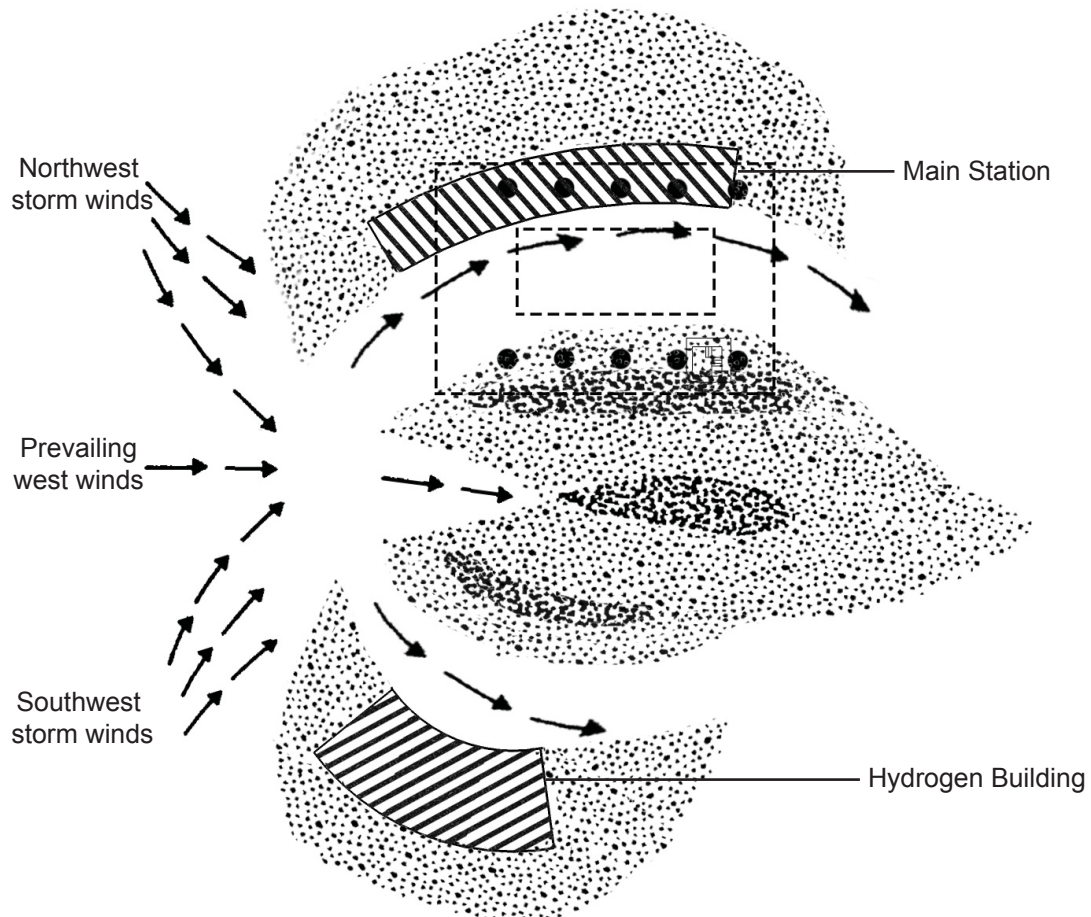

This sediment transport diagram shows anticipated points of sand accumulation and erosion at Main Station.

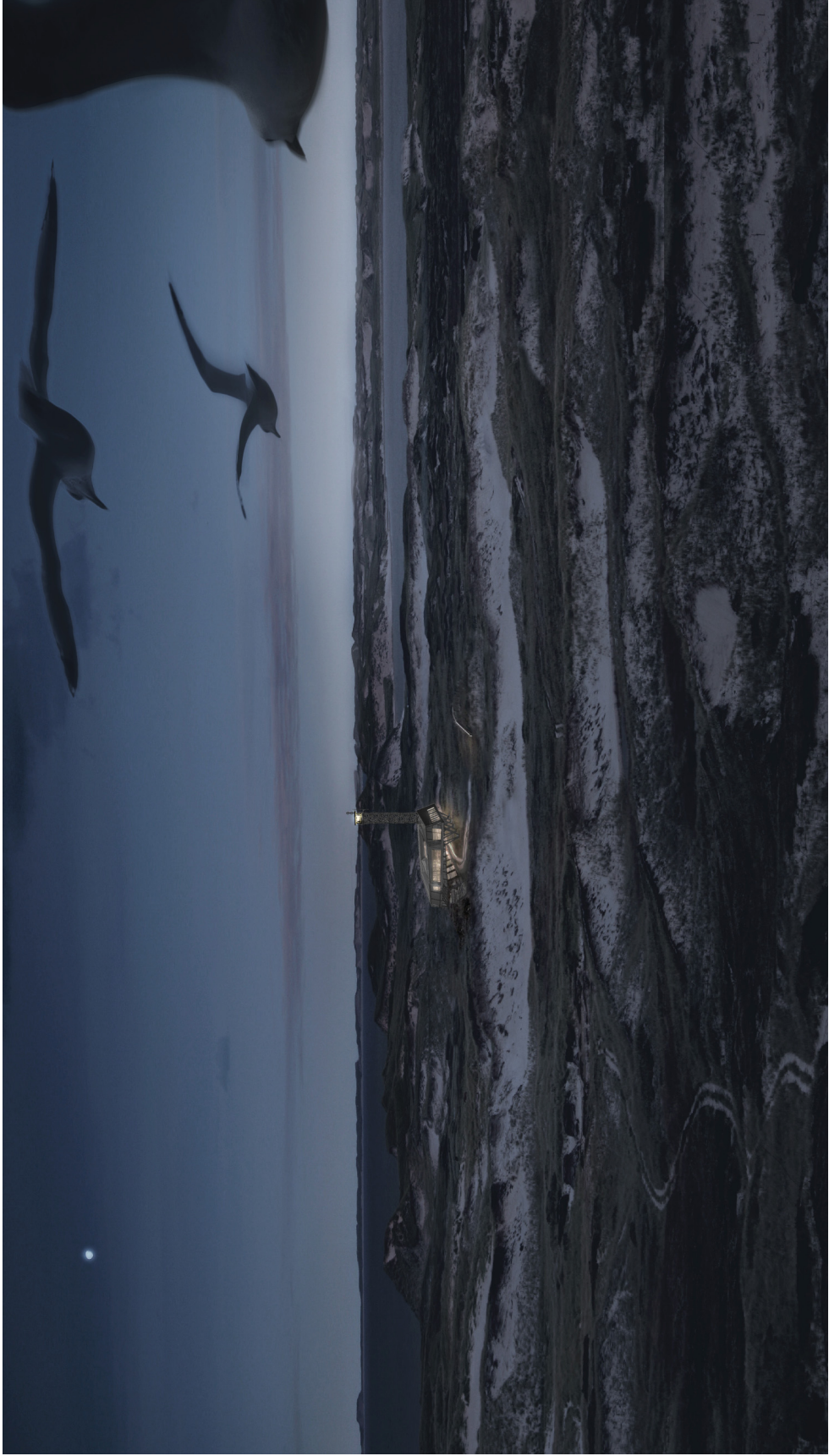

Main Station rises as an alien form, intentionally nestled in the fluid landscape. The tower facilitates weather data collection and radio signal transmission across the island. It also serves as a watch tower, providing excellent views for tourists and allows park staff and researchers to check runway conditions, monitor hiking groups, and observe wildlife.

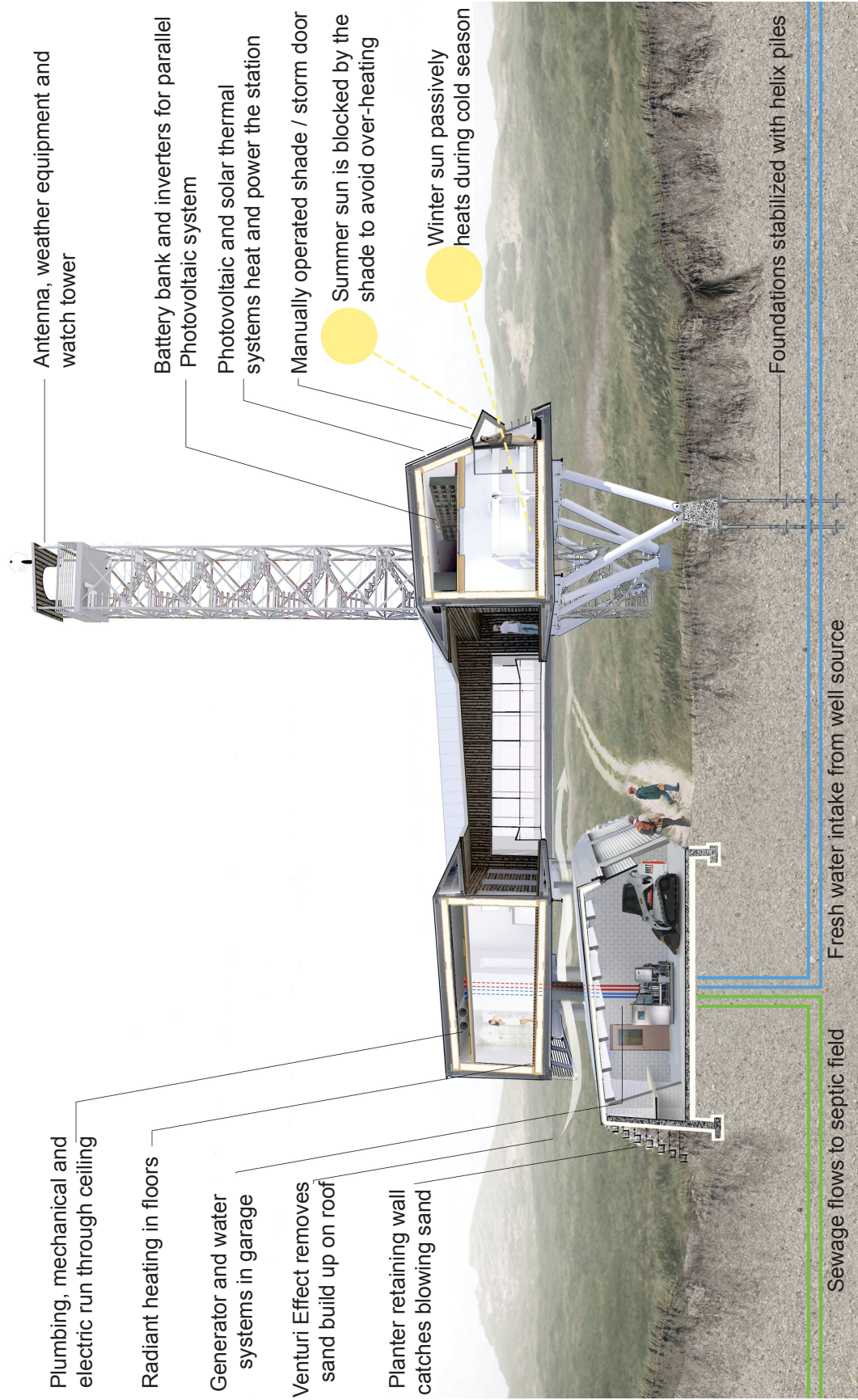

A section through Main Station demonstrates how its systems connect to the environment.

Water resources run to and from the artificial dune through water and sewage treatment machines. The sewage flows to the new septic field in the north dune where the tank farm once stood, enriching the habitat to encourage revegetation. Well water is treated and pumped into the north side of the courtyard.

All proposed structures are made with aluminum structural facades and lined with structural insulated panels. For ease of transport, construction and to reduce environmental impact on site, all proposed materials are prefabricated and modular.

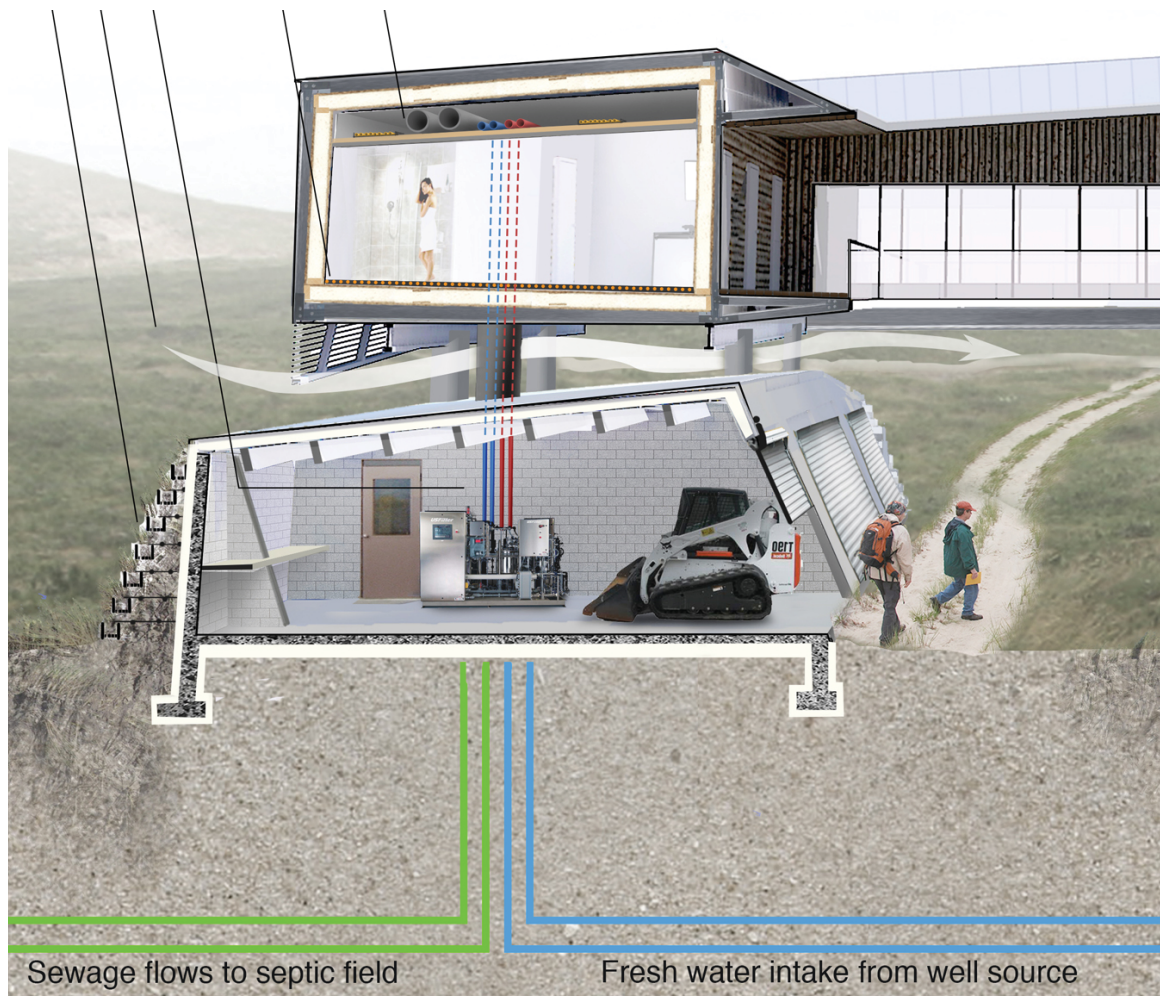
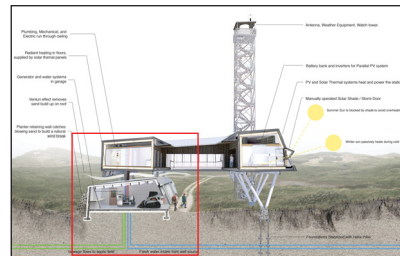

An enlarged view of the systems section.

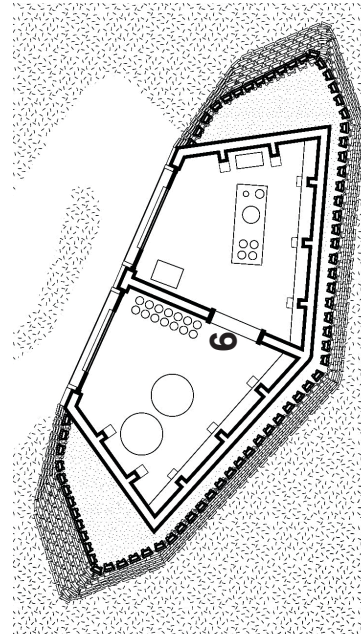
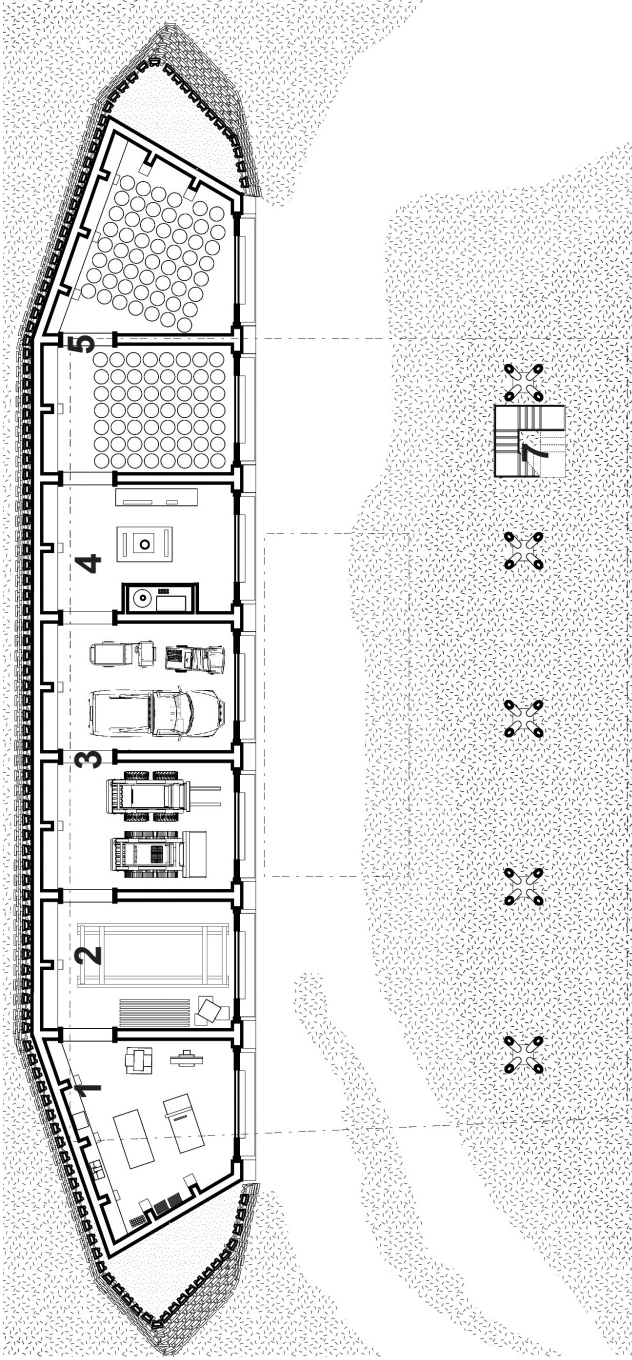

The ground level houses service spaces: the workshop (1), sled trailer (2), vehicle storage (3), water treatment and backup generator (4), fuel storage (5), and the hydrogen building (6). The hydrogen building is separated because its contents are very explosive and cannot be kept near electric systems. The tower can also be accessed from ground level (7).

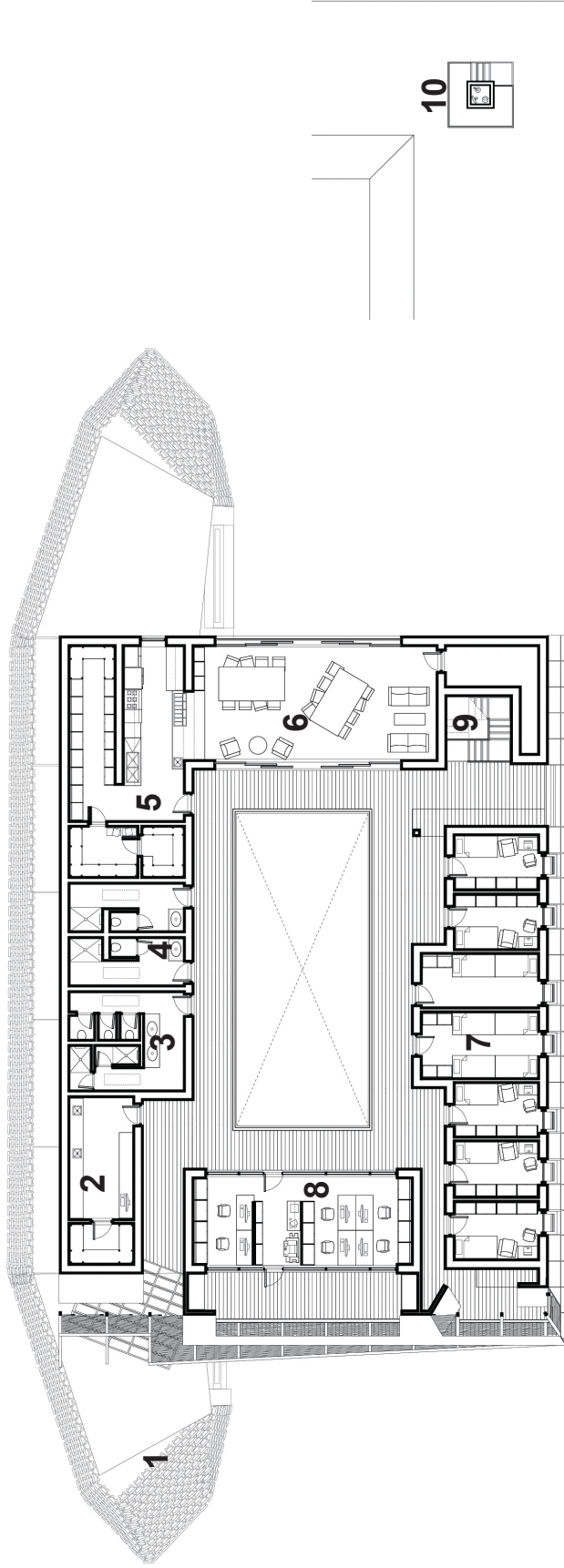

The upper level is accessed from the end of the artificial dune which forms a staircase to the main entrance (1). The upper level contains: the field lab (2), public washrooms (3), private staff washrooms (4), food storage and kitchen facilities (5), common room (6), group bunk rooms and private rooms (7), and office facilities (8). The tower can also be accessed at this level (9), and weather monitoring and radio equipment are kept at the top (10).



The courtyard connects visitors, staff, and researchers to their environment and to each other. Visual connections between work and recreation spaces, through circulation space, presents opportunities for social interaction. The west facing office and east facing common room frame the dunescape horizons. Fences are no longer needed as wildlife wander freely below the courtyard, undisturbed by the raised human settlement.

Every proposed structure provides a spatial sequence from landscape, through sheltered microclimates, to protected interiors.



After several years, the Main Station will be embraced by the landscape, joining the other strange artifacts in Sable Island's collection, and awakening inhabitants by its unexpected presence.



Photograph of the Main Station model's west facade.

CHAPTER 3: CONCLUSION

Designing with a dynamic ecosystem requires transforming information about natural processes into architectural knowledge. Interpreting site dynamics to create design guidelines allows one to propose processes for introducing elements of architecture in a dynamic system. This is demonstrated in the architecture proposed for Sable Island National Park; intentionally moved, eroded and buried, the interventions join the island's cyclical dance.

Inspired and informed by their place the architectural interventions proposed for Sable Island National Park are interpretations of their habitats. In their formal expression, spatial sequences and necessary adaptations, the hidden information they were designed with is revealed; one can unravel the island's logic by experiencing its architecture. Feeling the strong west wind, one understands the aerodynamic advantage of the sloping roof of the Visitor / Research centre. Sable Island's mild climate is experienced without its harsh wind when stepping into the Main Station courtyard, and the value of the island's lee spaces is perceived. Watching sand accumulate or erode around the shelters forecasts the eventual necessity for the buildings to follow the moving landscape on their ski foundations. Joining other artifacts buried in Sable Island's dunes, these objects in the landscape awaken those observing them to the dynamic nature of their environment.

Design work should not end with construction; observing the island's interactions with the new architecture will reveal potential for further innovation and change. Like any non-native organism introduced to an island ecosystem, the architecture can evolve over its generations until it is considered endemic to Sable Island.

The design method tested in this thesis can be applied to any dynamic ecosystem. These ecosystems will always challenge conventional building technologies and practices, requiring innovative solutions. With careful study, interpretation, and accommodation of natural processes, design can propose strategies for people to participate in the world's fragile and dynamic ecosystems.

REFERENCES

- Birch, Amanda. 2011. "Snøhetta's Wild Reindeer Centre Pavilion." *Building Design Online*. <http://www.bdonline.co.uk/snøhetta's-wild-reindeer-centre-pavilion/5028203.article>.
- Blocken, B., P. Moonen, T. Stathopoulos, J. Carmeliet. 2008. "A numerical study on the existence of the Venturi-effect in passages between perpendicular buildings". http://sts.bwk.tue.nl/urbanphysics/pdf/PREPRINT_ASCE_Venturi.pdf.
- Campbell, Lyall. 1974. *Sable Island: Fatal and Fertile Crescent*. Hantsport: Lancelot Press.
- Campbell, Lyall. 1994. *Sable Island Shipwrecks: Disaster and Survival at the North Atlantic Graveyard*. Halifax: Nimbus Publishing.
- Carlson, Kathryn Blaze. 2011. "Tiny Sable Island Canada's Newest National Park". *National Post*, October 18.
- Carwardine, Mark. 2012. "The Galapagos Islands: Trip of a Lifetime". *Telegraph*, September 9.
- Catling, P., B. Freedman, and Z. Lucas. 1984. *The Vegetation and Phytogeography of Sable Island, Nova Scotia*. Halifax. Nova Scotia Institute of Science.
- Corner, James. 1999. *Recovering Landscape: Essays in Contemporary Landscape Architecture*. New York: Princeton Architectural Press.
- Crosson Clarke Carnahan Architects. 2014. "Hut on Sleds." Accessed March 25. <http://ccca.co.nz/projects/hut-on-sleds>.
- De Villiers, Marq and Sheila Hirtle. 2004. *A Dune Adrift: The Strange Origins and Curious History of Sable Island*. Toronto: McClelland & Stewart.
- Emily deCamp Herbarium. 2013. "Thicket/ New York Aster." Accessed November 15. http://emilydecampherbarium.rutgers.edu/pages/New_York_Aster_jpg.htm.
- Fechner, Uwe and Roland Schmehl. 2012. *High level control and optimization of kite power systems*. Zurich: 8th PhD Seminar on Wind Energy in Europe.
- Garside, Debra. 2009. "The Wild Horses of Sable Island". *True North Fine Images*. Posted August 2. <http://www.truenorthfineimages.com/author/debra-garside/page/6/>.
- Gillings, Frank. 2013. "Introduction to Marram Grass". Accessed November 15, 2013. <http://www.tynemouth.frankgillings.com/marram.html>.
- Gray, David H. 1992. "Where has Sable Island Been for the Past 200 Years?". *CISM Journal ACSGC* Vol 46. Ottawa: Canadian Hydrographic Service.

- Grotto Hardscapes. 2014. "Retaining Wall Systems". Accessed March 25. <http://www.grottohardscapes.com/VERSA-Green-Plantable-Wall-System.html>.
- Helical Piles of New York. 2014. "Helical Pier Foundations". Accessed March 25. <http://helicalpilesny.com>.
- Hennigar, T. W. 1976. *Water Resources and Environmental Geology of Sable Island, Nova Scotia*. Halifax: Department of Environment.
- International Polar Foundation. 2013. "Inside the Station: Princess Elisabeth Antarctica Exhibition for Tour & Taxis." Published January 08. http://www.polarfoundation.org/news_press/press_release/inside_the_station_princess_elisabeth_antarctica_exhibition_for_tour_taxis.
- Ito, Toyo. 2014. "Aluminum Cottage Project." Accessed March 25. <http://www.lablog.org.uk/wp-content/070612-ito.pdf>.
- Kiteboarding Evolution. 2014. "The Wind Window". Accessed March 25. <http://www.kiteboardingevolution.com/wind-window.html>.
- Lengen, Johan van. 2008. *The barefoot architect: a handbook for green building*. Bolinas: Shelter Publications.
- Lucas, Zoe. 1980. *Terrain Management Activities on Sable Island 1979*. The Sable Island Environmental Advisory Committee.
- MacLeod, Paul. 2013. "Questions remain about Sable Island, our newest national park." *The Chronicle Herald*. July 2.
- Maritime Museum of the Atlantic. 2014. "Sable Island: Shipwrecks and Lifesaving". Accessed March 25. <http://maritimemuseum.novascotia.ca/research/sable-island>.
- Mathur, Anuradha and Dilip da Cunha. 2009. *SOAK: Mumbai in an estuary*. New Delhi: Rupa & Co.
- McConvey, Joel. 2012. "A Park Apart". *The Walrus Magazine*. May. <http://thewalrus.ca/a-park-apart/>.
- McHarg, Ian L. 1969. *Design With Nature*. Philadelphia: The Falcon Press.
- Mitcham, Allison. 1989. *Island Keepers*. Hantsport: Lancelot Press.
- Muise, Allison. 2011. *Sable Island, Nova Scotia: 2009 Topography and Land Cover Atlas*. Middleton: Applied Geomatics Research Group.
- National Park Service. 2012. "Half Dome Trail Stewardship Plan". Published December 2012. http://www.nps.gov/yose/parkmgmt/upload/Final_HD-FONSI-package.pdf.

- Nature Conservation (BIOL 3601). 2006. "Recommendations Regarding Potential Tourism on Sable Island." Accessed March 25, 2014. <http://sand.sableislandfriends.ca/wp/wp-content/uploads/2012/09/Sable-Island-Eco-Tourism-Reccomendations.pdf>.
- Needham, Joseph. 1965. *Science and Civilization in China Volume 4: Physics and Physical Technology, Part 2, Mechanical Engineering*. Cambridge: Cambridge University Press.
- Oakey, G.N. 1999. "Morphology Map, Topography / Bathymetry, Atlantic Region, Canada." Ottawa: Geological Survey of Canada.
- Paiva, J. and E. Lorient. 2013. "Honckenya". Accessed November 15. <http://www.flora-vascular.com/index.php?familia=Caryophyllaceae>.
- Panoramio. 2014. "Sable Island NS". Accessed March 23. <http://www.panoramio.com/photo/6393870>.
- Parks Canada. 2013. "Sable Island National Park Reserve: What's New". Accessed September 02. <http://www.pc.gc.ca/eng/pn-np/ns/sable/ne.aspx>.
- Parks Canada. 2014. "Auyuittuq National Park: Visitor Information Package." Accessed March 25. <http://www.pc.gc.ca/eng/pn-np/nu/ayuittuq/index.aspx>.
- Slavid, Ruth. 2010. "Halley VI Antarctic Research Station by Hugh Broughton Architects, Brunt Ice Shelf, Antarctica." *The Architectural Review*, 1361, Volume CCXXVIII, July. <http://www.architectural-review.com/halley-vi-antarctic-research-station-by-hugh-broughton-architects-brunt-ice-self-antarctica/8603050.article>.
- Toms, Brad, Horn, Andrew G., Boyne, Andrew W., and McKnight, Julie. 2014. "Report on the 2006 census of terns on Sable Island". Accessed March 25. <http://sand.sableislandfriends.ca/wp/wp-content/uploads/2012/09/SableTern2006Report.pdf>
- Wikimedia Commons. 2013a. "File:BlankMap-World-noborders.png". Accessed November 15. <http://commons.wikimedia.org/wiki/File:BlankMap-World-noborders.png>.
- Wikimedia Commons. 2013b. "File:Canada Nova Scotia location map.svg". Accessed November 15. http://commons.wikimedia.org/wiki/File:Canada_Nova_Scotia_location_map.svg.
- Wright, Frank L. 1943. *Frank Lloyd Wright: An Autobiography*. Petaluma: Barnes & Noble.
- Zimmer, Carl. 2009. "The Flesh of Physics." *Discover Magazine*. Published January 26. <http://blogs.discovermagazine.com/loom/2009/01/26/the-flesh-of-physics/#.Upe1J5GxGfs>.
- Zinck, Jack. 1979. *Shifting Sands*. Dartmouth: T & T Publishing Co.